



ACT Planning &  
Land Authority

# Residential Zones – Multi Unit Housing Development Code

March 2008



# Contents

Introduction .....	1
<b>Part A - Zone Specific Controls .....</b>	<b>3</b>
<b>Part A(1) - RZ1 - Suburban Zone .....</b>	<b>3</b>
<b>Element 1: Restrictions on Use.....</b>	<b>3</b>
1.1 Subdivision of Blocks.....	3
1.2 Number of Dwellings per Block .....	3
1.3 Site Area Requirements for Dual Occupancy Housing .....	3
1.4 Residential Redevelopment.....	3
<b>Element 2: Building and Site Controls .....</b>	<b>4</b>
2.1 Height .....	4
2.2 Height of Dwelling/s at the Rear of Block .....	4
2.3 Building Envelope.....	4
2.4 Plot Ratio .....	5
<b>Part A(2) - RZ2 - Suburban Core Zone .....</b>	<b>7</b>
<b>Element 1: Restrictions on Use.....</b>	<b>7</b>
1.1 7	7
1.2 Site Area Requirements for Dual Occupancy Housing .....	7
1.3 Site Area Requirements for Multi Unit Housing (other than dual occupancy housing) - .....	7
<b>Element 2: Building and Site Controls .....</b>	<b>7</b>
2.1 Height .....	8
2.2 Building Envelope.....	8
2.3 Plot Ratio .....	9
<b>Element 4: Parking and Site Access.....</b>	<b>10</b>
4.1 Vehicle Access .....	10
<b>Part A(3) - RZ3 - Urban Residential Zone .....</b>	<b>11</b>
<b>Element 2: Building and Site Controls .....</b>	<b>11</b>
2.1 Height .....	11
2.2 Building Envelope.....	11
2.3 Plot Ratio .....	12
<b>Part A(4) - RZ4 - Medium Density Residential Zone .....</b>	<b>13</b>
<b>Element 2: Building and Site Controls .....</b>	<b>13</b>
2.1 Restrictions on Use – Staging of Development - Inner North Canberra .....	13
2.2 Height .....	13
2.3 Building Envelope.....	13
2.4 Plot Ratio .....	14
<b>Part A(5) - RZ5 – High Density Residential Zone .....</b>	<b>15</b>
<b>Element 2: Building and Site Controls .....</b>	<b>15</b>
2.1 Height .....	15
<b>Part B - General Development Controls .....</b>	<b>17</b>
<b>Element 1: Restrictions on Use.....</b>	<b>17</b>
1.1 Subdivision of Existing Residential Leases (except RZ1 Zone).....	17
<b>Element 2: Building and Site Controls .....</b>	<b>17</b>
2.1 Demolition.....	18
2.2 National Capital Plan Requirements .....	18
2.3 Estate Development Plans approved prior to 31 March 2008.....	18
2.4 Estate Development Plans approved post 31 March 2008 .....	18
2.5 Height .....	19
2.6 Plot Ratio .....	19
<b>Element 3: Built Form.....</b>	<b>19</b>
3.1 Crime Prevention Through Environmental Design .....	19
3.2 Access and Mobility.....	20

<b>Element 4:</b>	Parking and Site Access.....	<b>20</b>
4.1	Traffic Generation.....	20
4.2	Parking.....	20
<b>Element 6:</b>	Environment.....	<b>20</b>
6.1	Heritage.....	21
6.2	Trees.....	21
6.3	Hazardous Materials.....	21
6.4	Contamination.....	22
6.5	Erosion and Sediment Control.....	22
6.6	Signs.....	22
6.7	Water Sensitive Urban Design – Mains Water Consumption.....	22
6.8	Water Sensitive Urban Design – Stormwater Quality.....	23
6.9	Water Sensitive Urban Design – Stormwater Quantity.....	23
<b>Element 7:</b>	Services.....	<b>23</b>
7.1	Waste Management.....	24
7.2	Servicing and Site Management.....	24
7.3	Utilities.....	24
<b>Part C - Development Type Controls</b>	.....	<b>25</b>
<b>Part C(1) - Multi Unit Housing</b>	.....	<b>25</b>
<b>Element 2:</b>	Building and Site Controls.....	<b>25</b>
2.1	Front Street Setback.....	26
2.2	Side Setback.....	27
2.3	Rear Setback.....	28
<b>Element 3:</b>	Built Form.....	<b>29</b>
3.1	Building Design.....	29
3.2	Materials and Finish.....	29
3.3	Interface.....	30
3.4	Accessibility (mobility).....	33
<b>Element 4:</b>	Parking and Site Access.....	<b>33</b>
4.1	Vehicle Access.....	33
4.2	Parking.....	36
<b>Element 5:</b>	Amenity.....	<b>37</b>
5.1	Solar Access.....	38
5.2	Neighbourhood Plans.....	38
5.3	Private Open Space.....	38
5.4	Landscaping.....	39
5.5	Common Areas.....	39
<b>Element 7:</b>	Services.....	<b>39</b>
7.1	Site Facilities.....	39
<b>Part C(2) – Multi Unit Housing - Additional Controls for Deakin and Forrest</b>	.....	<b>41</b>
<b>Element 2:</b>	Building and Site Controls.....	<b>41</b>
2.1	Height (Additional Control).....	41
2.2	Front Street Setback (Replaces C(1) R53/C53).....	41
2.3	Side and Rear Setbacks (Replaces C(1)R54/C54 and C(1)R55/C55).....	41
<b>Element 3:</b>	Built Form.....	<b>42</b>
3.1	Materials and Finish (Additional Control).....	42
<b>Element 5:</b>	Amenity.....	<b>42</b>
5.1	Landscaping (Additional Control).....	42
<b>Part C(3) - Multi Unit Housing – Inner North Canberra and Gungahlin District - RZ3 and RZ4 Zones</b>	.....	<b>43</b>
<b>Element 2:</b>	Building and Site Controls.....	<b>43</b>
2.1	Height.....	43
2.2	Front Street Setback.....	43
2.3	Side and Rear Setback.....	45
2.4	Building Envelope.....	45

<b>Element 3:</b>	Built Form.....	<b>46</b>
	3.1 Building Design.....	46
	3.2 Materials and Finish .....	48
	3.3 Interface.....	49
	3.4 Accessibility (Mobility) .....	50
	3.5 Crime Prevention.....	51
<b>Element 4:</b>	Parking and Site Access.....	<b>51</b>
	4.1 Vehicle Access .....	52
	4.2 Parking.....	53
	4.3 Circulation.....	54
<b>Element 5:</b>	Amenity .....	<b>54</b>
	5.1 Solar Access.....	55
	5.2 Neighbourhood Plans .....	55
	5.3 Private Open Space .....	56
	5.4 Communal Open Space .....	57
	5.5 Landscaping .....	57
	5.6 Acoustic Privacy .....	59
	5.7 Natural Ventilation .....	60
<b>Element 7:</b>	Services .....	<b>60</b>
	7.1 Utilities .....	60
	7.2 Storage Area.....	60
	7.3 Service Areas .....	60
<b>Part C(4) - Multi Unit Housing – Kingston/Griffith – RZ5 Zone.....</b>		<b>62</b>
<b>Element 2:</b>	Building and Site Controls .....	<b>62</b>
	2.1 Block Amalgamations – Kingston Sections 27 and 28.....	62
	2.2 Redevelopment on Other Sections .....	62
	2.3 Building Height.....	63
	2.4 Building Height – Kingston Sections 27 and 28 .....	63
	2.5 Side and Rear Setback.....	63
	2.6 Interface.....	63
<b>Element 3:</b>	Built Form.....	<b>64</b>
	3.1 Building Design.....	64
	3.2 Building Design – Ground Floor Commercial Uses.....	65
	3.3 Materials and Finish .....	65
	3.4 Interface.....	65
	3.5 Courtyard Walls .....	66
	3.6 Accommodation Diversity .....	66
<b>Element 4:</b>	Parking and Site Access.....	<b>67</b>
	4.1 Vehicle Access .....	67
	4.2 Parking.....	67
<b>Element 5:</b>	Amenity .....	<b>68</b>
	5.1 Communal Open Space .....	68
	5.2 Private Open Space .....	68
	5.3 Landscape .....	68
<b>Element 7:</b>	Services .....	<b>69</b>
	7.1 Easements and Utilities.....	69
<b>Part C(5) - Multi Unit Housing – Other Areas – RZ4 and RZ5 Zones and All Areas in the Commercial Zones.....</b>		<b>70</b>
<b>Element 3:</b>	Built Form.....	<b>70</b>
	3.1 Accommodation Diversity .....	70
	3.2 Entries.....	71
	3.3 Interface.....	72
<b>Element 4:</b>	Parking and Site Access.....	<b>72</b>
	4.1 Circulation.....	73
	4.2 Parking.....	74

<b>Element 5:</b>	Amenity .....	<b>75</b>
	5.1 Visual Privacy .....	75
	5.2 Solar Access.....	75
	5.3 Neighbourhood Plans .....	76
	5.4 Natural Ventilation .....	76
	5.5 Noise.....	77
	5.6 Private Open Space .....	78
	5.7 Communal Open Space .....	79
<b>Element 7:</b>	Services .....	<b>80</b>
	7.1 Lighting .....	81
	7.2 Mailboxes.....	81
	7.3 Clothes Drying .....	81
	7.4 Storage .....	81
<b>Part D - Development Type Controls - Other Forms of Residential Development and Non-Residential Development .....</b>		<b>87</b>
<b>Element 1:</b>	Restrictions on Use.....	<b>87</b>
	1.1 Development Standards .....	87
	1.2 Plot Ratio .....	87
	1.3 Habitable Suite .....	87
	1.4 Relocatable Unit .....	88
	1.5 Boarding House, Child Care Centre, Community Activity Centre and Residential Care Accommodation .....	89
	1.6 Supportive Housing .....	89
	1.7 Guest House.....	90
	1.8 Health Facility .....	90
	1.9 Business Agency, Office, Restaurant, Shop .....	90
	1.10 Home Business.....	91
	1.11 Barton, Section 17, Block 4 .....	91
	1.12 Use of Buildings – Narrabundah, Section 100, Blocks 11, 12, 37, 44, 45, 2, 19, 21 and 20.....	91

# Introduction

## Application of the code

This Development Code applies to development for multi unit housing in the Residential Zones being RZ1 – Suburban Zone, RZ2 – Suburban Core Zone, RZ3 - Urban Residential Zone, RZ4 - Medium Density Zone and RZ5 - High Density Zone.

Part C(5) of this Code also applies to development for multi unit housing in the Commercial Zones being CZ1 – Core Zone, CZ2 – Business Zone, CZ3 – Services Zone, CZ4 - Local Centre Zone, CZ5 – Mixed Use Zone and CZ6 – Leisure and Accommodation Zone. Part C (5) applies in conjunction with the relevant Commercial Development Code or Precinct Code in Volume 1 at Sections 4.1 – 4.8 and Section 10.2.

Multi unit housing is identified in the zones' development tables as being within the merit assessment track.

This Development Code also applies to other forms of residential development (not including single dwelling housing) and non-residential forms of development that are identified in the zones' development table as being within the merit assessment tracks.

## Purpose of codes

Codes provide additional planning, design and environmental controls to support the zone objectives and assessable uses in the development tables.

The Codes are used by the Authority to assess development applications. The Codes therefore also provide guidance to intending applicants in designing their developments and preparing their development applications.

Each Code's controls are expressed as either **rules**, which are generally definitive and quantitative, or as qualitative **criteria**.

- Proposals in the **code track** must comply with all rules relevant to the development.
- Proposals in the **merit track** and **impact track** have the option to comply with the rules or criteria, unless the rule is mandatory. Where it is proposed to meet the criteria, the onus is on the applicant to demonstrate, by supporting plans and written documentation, that the proposed development satisfies the criteria and therefore the intent of the element.
- Proposals in the **impact track** also have the option to justify any non-compliance with the rules and the criteria, unless the rule is mandatory. Where it is proposed to not meet the rules and the criteria, the onus is on the applicant to justify the non-compliance by demonstrating that the proposed development is consistent with the relevant principles of the Statement of Strategic Directions. Supporting plans and written documentation, providing consideration of the relevant Intents of the Code and the Zone objectives, are to accompany the development application.

## Structure of codes

The Residential Zones – Multi unit Housing Development Code is divided into four Parts:

**Part A – Zone Specific Controls** provide any specific controls for each Residential Zone.

**Part B – General Development Controls** provide general controls that are applicable to all development, subject to this Code, within the Residential Zones.

**Part C – Development Type Controls** provide the specific controls for multi unit housing. This Part is divided into five sub-parts to differentiate between types of multi unit housing and area specific requirements:

- **Part C(1) - Multi unit housing** provide the controls for all multi unit housing, except in those circumstances where Parts C(2) - C(5) would apply.

- **Part C(2) - Multi unit housing – Additional Controls for part of Deakin and Forrest** provide the controls for individual Sections in Deakin and Forrest where additional controls, or substitute controls, are necessary to guide the development outcome in these historic sectors of South Canberra.
- **Part C(3) - Multi unit housing –Inner North Canberra and Gungahlin District - RZ3 and RZ4 Zones** provide the controls for multi unit housing in the RZ3 - Urban Residential and RZ4 – Medium Density Residential Zones in Inner North Canberra and the Gungahlin District.
- **Part C(4) - Multi unit housing –Kingston/Griffith - RZ5 Zone** provide the controls for multi unit housing in the R5 Zone as it applies to Kingston and Griffith
- **Part C(5) - Multi unit housing – Other areas in the RZ4 and RZ5 Zones and all areas in the Commercial Zones** provide the controls for multi unit housing in the RZ4 – Medium Density and RZ5 – High Density Zones as they apply to Belconnen, Bruce, Hawker, Narrabundah, Woden District and Tuggeranong District and the CZ1 – Core, CZ2 – Business, CZ3 – Services, CZ4 Local Centre, CZ5 – Mixed Use and CZ6 – Leisure and Accommodation Zones as they apply to all commercial areas.
- **Part 4 - Development Type Controls** provide any specific controls for other forms of residential development (not including single dwelling housing) and for non-residential development in all Residential Zones.

Care is needed to check whether any specific controls apply to individual sites.

Each Part is divided into sections referred to as **Elements**, although each Part may not include provisions for every Element. The Elements describe the various issues for consideration:

1. Restrictions on Use
2. Building and Site Controls
3. Built Form
4. Parking and Site Access
5. Amenity
6. Environment
7. Services

Each Element consists of Intents and Items under which are Rules and Criteria.

**Intent** describes the purpose of the development controls

**Rules** provide the quantitative, or definitive, controls for development

**Criteria** provide the qualitative controls for development

In some instances, there are rules that are mandatory. For clarity of use, the mandatory rules are emphasised by the following words: “**This is a mandatory requirement. There is no applicable criterion**”. Non-compliance with these provisions will result in the refusal of a development application. Conversely, the words “**There is no applicable rule**” is used when controls cannot be quantitative or definitive and only criteria exist.

Any application of a **General Code** to a development proposal, is identified as part of the relevant rule or criteria.

Where more than one type of Code applies to a development, the order of precedence when there is inconsistency of provisions between Codes, as defined by the Act, is **Precinct Code**, then **Development Code**, and then **General Code**.

### Further information

Please refer to the Development Application Guide, for more information on preparing applications under the Territory Plan, including the use of assessment codes.



## Part A - Zone Specific Controls

This Part provides the specific controls that apply to each individual Residential Zone. It is to be read in conjunction with Parts B and C.

### Part A(1) - RZ1 - Suburban Zone

#### Element 1: Restrictions on Use

##### Intent:

- a) To allow a limited level of additional housing to meet changing community needs and preferences whilst ensuring development is of a density compatible with adjoining development

Rules	Criteria
<b>1.1 Subdivision of Blocks</b>	
<p>R1</p> <p>Subdivision (including Unit Titles subdivision) is only permitted where:</p> <p>a) land is not registered on the heritage register, and development is for supportive housing purposes</p> <p>b) land is not registered on the heritage register and all of the dwellings were lawfully constructed or approved before 17 June 2003 and for which a development application had been lodged by 1 September 2003</p> <p>c) The block is not a standard block</p>	<p>This is a mandatory requirement. There is no applicable criterion.</p>
<b>1.2 Number of Dwellings per Block</b>	
<p>R2</p> <p>On a standard block, the maximum number of dwellings permitted is two, unless the development is for the purpose of supportive housing.</p>	<p>This is a mandatory requirement. There is no applicable criterion.</p>
<b>1.3 Site Area Requirements for Dual Occupancy Housing</b>	
<p>R3</p> <p>The minimum site area for dual occupancy housing is 800 m<sup>2</sup>.</p>	<p>This is a mandatory requirement. There is no applicable criterion.</p>
<b>1.4 Residential Redevelopment</b>	
<p>There is no applicable rule.</p>	<p>C4</p> <p>Notwithstanding R2 and R3, residential redevelopment on blocks originally used for multi-unit housing may be approved subject to</p>

Rules	Criteria
	consideration of adverse impacts resulting from any increase in building bulk.

## Element 2: Building and Site Controls

### Intent:

- a) To ensure buildings are compatible with, and complement, the built form, siting and scale of surrounding properties and are of an appropriate residential character
- b) To ensure buildings are designed and sited to:
  - i) provide privacy between neighbours and between occupants and the public
  - ii) provide adequate light and natural ventilation between dwellings
  - iii) provide opportunities for additional landscaping and to deliver quality open space
  - iv) maintain or enhance the streetscape character in existing areas
  - v) establish appropriate and attractive streetscapes in new residential areas
- c) To ensure the amenity of surrounding properties is maintained, particularly in relation to privacy, overshadowing and solar access

Rules	Criteria
<b>2.1 Height</b>	
<p>R5</p> <p>Buildings do not exceed 2 storeys.</p> <p>On a standard block attics or basement car parking are not permitted where they are located directly above or below any 2 storey element of the dwelling.</p>	<p>C5</p> <p>Buildings to be limited in height to ensure compatibility with adjacent development and may include a basement and/or an attic.</p> <p>On a standard block attics or basement car parking are not permitted where they are located directly above or below any 2-storey element of the dwelling.</p>
<b>2.2 Height of Dwelling/s at the Rear of Block</b>	
<p>R6</p> <p>On a standard block, multi unit housing that does not directly front a public road from which vehicular access is permitted is single storey with no basement car parking.</p>	<p>This is a mandatory requirement. There is no applicable criterion.</p>
<b>2.3 Building Envelope</b>	
<p>R7</p> <p>Buildings are sited wholly within the building envelope (refer Figure A1) defined by:</p> <ol style="list-style-type: none"> <li>a) Blocks that are the north facing boundary of an adjoining residential block: <ol style="list-style-type: none"> <li>i) within the <i>primary building zone (PBZ)</i>, planes projected at 45 degrees above</li> </ol> </li> </ol>	<p>C7</p> <p>The built form does not adversely impact on the amenity of neighbouring properties by ensuring:</p> <ol style="list-style-type: none"> <li>a) sufficient spatial separation between adjoining developments</li> <li>b) the protection of a reasonable amount of privacy and solar access to adjacent</li> </ol>

Rules	Criteria
<p>horizontal from a height of 2 m above natural ground level at the side boundaries, up to a maximum building height of 8.5 m above natural ground level</p> <p>ii) within the <i>rear zone (RZ)</i>, planes projected at 30 degrees above horizontal from a height of 2 m above natural ground level at the side and rear boundaries, up to a maximum of 8.5 m above natural ground level.</p> <p>b) All other side and rear boundaries:</p> <p>i) within the <i>primary building zone (PBZ)</i>, planes projected at 45 degrees above horizontal from a height of 3.5 m above natural ground level at the side boundaries, up to a maximum building height of 8.5 m above natural ground level</p> <p>ii) within the <i>rear zone (RZ)</i>, planes projected at 30 degrees above horizontal from a height of 3.5 m above natural ground level at the side and rear boundaries, up to a maximum of 8.5 m above natural ground level.</p>	<p>dwellings and their associated private open space.</p>
<b>2.4 Plot Ratio</b>	
<p>R8</p> <p>For dual occupancy housing, on a standard block, the maximum plot ratio does not exceed the calculation determined by the following formula:</p> $P = (140/B + 0.15) \times 100$ <p>Where:</p> <p>P is the maximum permissible plot ratio expressed as a percentage</p> <p>B is the block area in square metres.</p>	<p>This is a mandatory requirement. There is no applicable criterion.</p>

Rules	Criteria
<p>R9</p> <p>In addition to R8, for dual occupancy housing, the maximum plot ratio for any additional new dwelling that does not directly front a public road from which vehicular access is permitted does not exceed half of the permissible plot ratio of all development on the block or 17.5%, whichever is the lesser.</p>	<p>This is a mandatory requirement. There is no applicable criterion.</p>

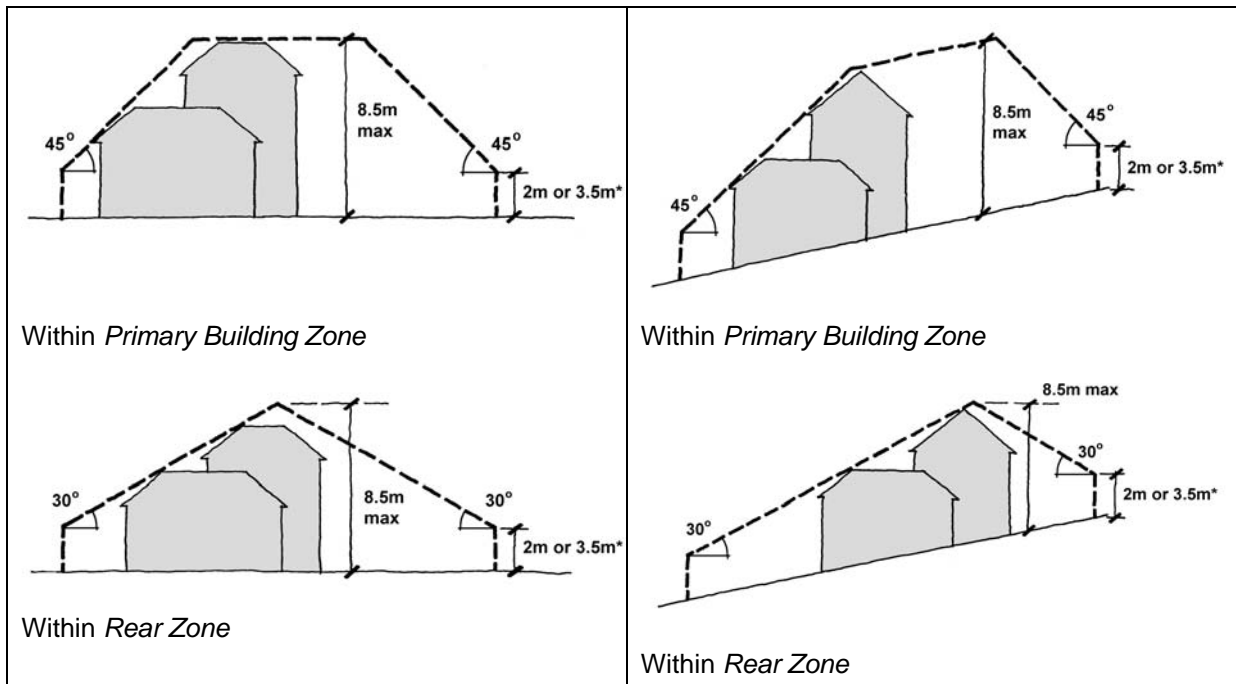

Flat Site	Sloping Site
-----------	--------------

### Figures A1 Building Envelope

\*2 metres where the boundary is a north facing boundary of an adjoining residential block, or 3.5 metres for other side or rear boundaries

Note. Where a maximum plot ratio is specified the gross floor area of the development used in the calculation of the plot ratio shall be taken to be the gross floor area of the buildings plus 18m<sup>2</sup> for each roofed open car space or car port provided to meet Territory requirements for resident car parking (not including basement car parking) and the area of any balcony that is roofed and substantially enclosed by solid walls.

## Part A(2) - RZ2 - Suburban Core Zone

### Element 1: Restrictions on Use

#### Intent:

To allow a moderate level of flexibility to accommodate a variety of additional housing to meet changing community needs and preferences whilst ensuring development is of a density that respects adjoining development

Rules	Criteria
<b>1.1</b>	
R10 On a standard block, the maximum number of dwellings permitted is three, unless the block is greater than 20m wide.	This is a mandatory requirement. There is no applicable criterion.
<b>1.2 Site Area Requirements for Dual Occupancy Housing</b>	
R11 The minimum site area for dual occupancy housing is 800 m <sup>2</sup> .	This is a mandatory requirement. There is no applicable criterion.
<b>1.3 Site Area Requirements for Multi Unit Housing (other than dual occupancy housing) -</b>	
R12 On a standard block, the minimum site area for triple occupancy and other multi-unit housing is 1400 m <sup>2</sup> .	This is a mandatory requirement. There is no applicable criterion.

### Element 2: Building and Site Controls

#### Intent:

- a) To ensure buildings are compatible with, and complement, the built form, siting and scale of surrounding properties and are of an appropriate residential character
- b) To ensure buildings are designed and sited to:
  - i) provide privacy between neighbours and between occupants and the public
  - ii) provide adequate light and natural ventilation between dwellings
  - iii) provide opportunities for additional landscaping and to deliver quality open space
  - iv) enhance the streetscape character in existing areas
  - v) establish appropriate and attractive streetscapes in new residential areas
- c) To ensure the amenity of surrounding properties is maintained, particularly in relation to privacy, overshadowing and solar access

Rules	Criteria
<b>2.1 Height</b>	
<p>R13</p> <p>Buildings do not exceed 2 storeys. Attics, basements or basement car parking are permitted.</p>	<p>C13</p> <p>Buildings to be limited in height to ensure compatibility with adjacent development and may include a basement and/or an attic.</p>
<b>2.2 Building Envelope</b>	
<p>R14</p> <p>Buildings are sited wholly within the building envelope (refer Figure A2) defined by:</p> <p>a) Blocks that are the north facing boundary of an adjoining residential block:</p> <ul style="list-style-type: none"> <li>i) within the <i>primary building zone (PBZ)</i>, planes projected at 45 degrees above horizontal from a height of 2 m above natural ground level at the side boundaries, up to a maximum building height of 8.5 m above natural ground level</li> <li>ii) within the <i>rear zone (RZ)</i>, planes projected at 30 degrees above horizontal from a height of 2 m above natural ground level at the side and rear boundaries, up to a maximum of 8.5 m above natural ground level.</li> </ul> <p>b) All other side and rear boundaries:</p> <ul style="list-style-type: none"> <li>i) within the <i>primary building zone (PBZ)</i>, planes projected at 45 degrees above horizontal from a height of 3.5 m above natural ground level at the side boundaries, up to a maximum building height of 8.5 m above natural ground level</li> <li>ii) within the <i>rear zone (RZ)</i>, planes projected at 30 degrees above horizontal from a height of 3.5 m above natural ground level at the side and rear boundaries, up to a maximum of 8.5 m above natural ground level.</li> </ul>	<p>C14</p> <p>The built form does not adversely impact on the amenity of neighbouring properties by ensuring:</p> <ul style="list-style-type: none"> <li>a) sufficient spatial separation between adjoining developments</li> <li>b) the protection of a reasonable amount of privacy and solar access to adjacent dwellings and their associated private open space.</li> </ul>

Rules	Criteria
<b>2.3 Plot Ratio</b>	
<p>R15</p> <p>On a standard block (or a block resulting from the consolidation of these blocks), the maximum plot ratio does not exceed 50%, except for dual or triple occupancy housing, where at least one dwelling does not directly front a public road from which vehicular access is permitted, the plot ratio does not exceed 35%.</p>	<p>This is a mandatory requirement. There is no applicable criterion.</p>
<p>R16</p> <p>In addition to R15, for dual occupancy housing, the maximum plot ratio for any additional new dwelling that does not directly front a public road from which vehicular access is permitted does not exceed half of the permissible plot ratio of all development on the block or 17.5%, whichever is the lesser.</p>	<p>This is a mandatory requirement. There is no applicable criterion.</p>

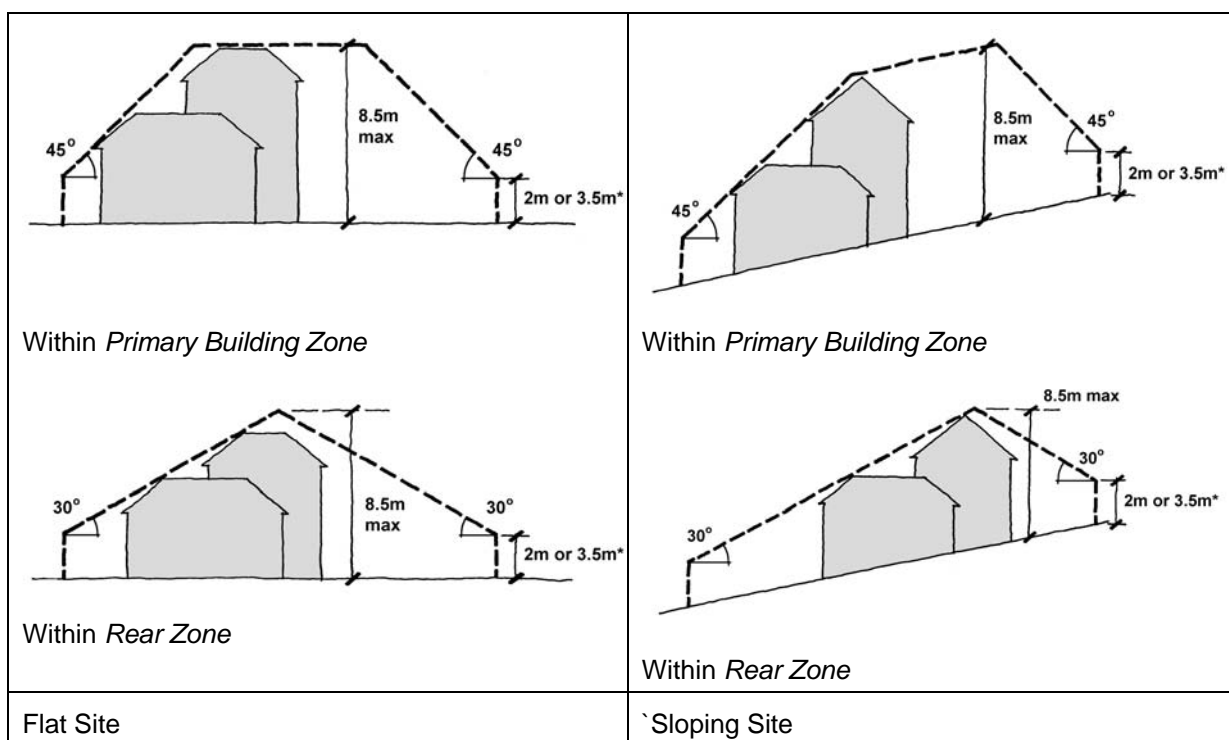

**Figure A2 Building Envelope**

\*2 metres where the boundary is a north facing boundary of an adjoining residential block, or 3.5 metres for other side or rear boundaries

Note. Where a maximum plot ratio is specified the gross floor area of the development used in the calculation of the plot ratio shall be taken to be the gross floor area of the buildings plus 18m<sup>2</sup> for each roofed open car space or car port provided to meet Territory requirements for resident car parking (not including basement car parking) and the area of any balcony that is roofed and substantially enclosed by solid walls.

## Element 4: Parking and Site Access

### Intent:

- a) To encourage design of access and parking as part of the overall design of the development
- b) To provide sufficient, convenient, accessible and safe parking to meet the needs of the residents and visitors
- c) To ensure that parking facilities do not detract from streetscape amenity and surveillance of the street

Rules	Criteria
<b>4.1 Vehicle Access</b>	
<b>R17</b> On a standard block, ramps accessing basement car parking are not permitted forward of the building line, where the block is less than 30 m wide. Ramps comply with the relevant Australian Standard.	<b>C17</b> Ramps to be limited in their extent to maintain streetscape amenity and allow safe and efficient vehicle and pedestrian movement.



## Part A(3) - RZ3 - Urban Residential Zone

### Element 2: Building and Site Controls

#### Intent:

- a) To ensure buildings are compatible with, and complement, the built form, siting and scale of surrounding properties and are of an appropriate residential character
- b) To ensure buildings are designed and sited to:
  - i) provide privacy between neighbours and between occupants and the public
  - ii) provide adequate light and natural ventilation between dwellings
  - iii) provide opportunities for additional landscaping and to deliver quality open space
  - iv) enhance the streetscape character in existing areas
  - v) establish appropriate and attractive streetscapes in new residential areas
- c) To ensure the amenity of surrounding properties is maintained, particularly in relation to privacy, overshadowing and solar access

Rules	Criteria
<b>2.1 Height</b>	
R18 Buildings do not exceed 2 storeys.	C18 Buildings to be limited in height to ensure compatibility with adjacent development and may include a basement and/or an attic.
<b>2.2 Building Envelope</b>	
R19 Buildings are sited wholly within the building envelope (refer Figure A3) defined by: <ul style="list-style-type: none"> <li>a) Blocks that are the north facing boundary of an adjoining residential block:               <ul style="list-style-type: none"> <li>i) within the <i>primary building zone (PBZ)</i>, planes projected at 45 degrees above horizontal from a height of 2 m above natural ground level at the side boundaries, up to a maximum building height of 8.5 m above natural ground level</li> <li>ii) within the <i>rear zone (RZ)</i>, planes projected at 30 degrees above horizontal from a height of 2 m above natural ground level at the side and rear boundaries, up to a maximum of 8.5 m above natural ground level.</li> </ul> </li> <li>b) All other side and rear boundaries:               <ul style="list-style-type: none"> <li>i) within the <i>primary building zone (PBZ)</i>,</li> </ul> </li> </ul>	C19 The built form does not adversely impact on the amenity of neighbouring properties by ensuring: <ul style="list-style-type: none"> <li>a) sufficient spatial separation between adjoining developments</li> <li>b) the protection of a reasonable amount of privacy and solar access to adjacent dwellings and their associated private open space.</li> </ul>

Rules	Criteria
<p>planes projected at 45 degrees above horizontal from a height of 3.5 m above natural ground level at the side boundaries, up to a maximum building height of 8.5 m above natural ground level</p> <p>ii) within the <i>rear zone (RZ)</i>, planes projected at 30 degrees above horizontal from a height of 3.5 m above natural ground level at the side and rear boundaries, up to a maximum of 8.5 m above natural ground level.</p>	

### 2.3 Plot Ratio

<p>R20</p> <p>Maximum plot ratio does not exceed 65%.</p>	<p>This is a mandatory requirement. There is no applicable criterion.</p>
---	---

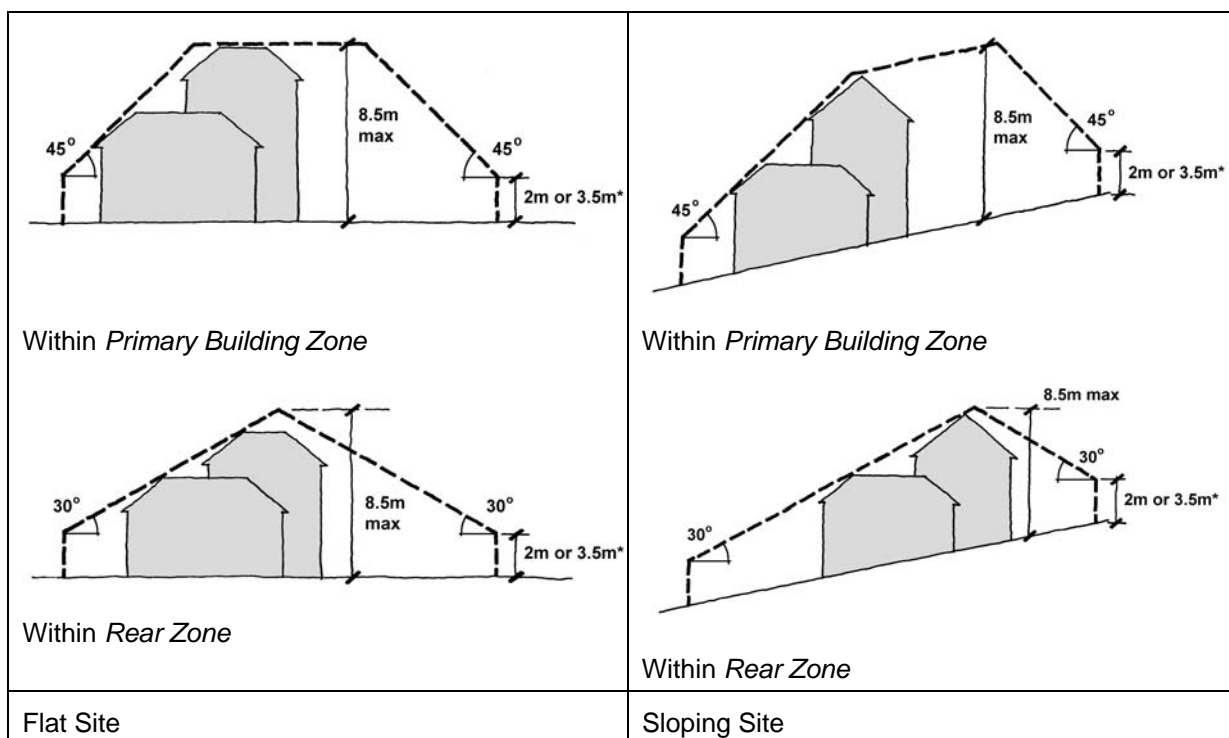

**Figure A3 Building Envelope**

\*2 metres where the boundary is a north facing boundary of an adjoining residential block, or 3.5 metres for other side or rear boundaries

Note. Where a maximum plot ratio is specified the gross floor area of the development used in the calculation of the plot ratio shall be taken to be the gross floor area of the buildings plus 18m<sup>2</sup> for each roofed open car space or car port provided to meet Territory requirements for resident car parking (not including basement car parking) and the area of any balcony that is roofed and substantially enclosed by solid walls.

## Part A(4) - RZ4 - Medium Density Residential Zone

### Element 2: Building and Site Controls

#### Intent:

- a) To provide for a range of residential forms that respect the residential character of the locality
- b) To ensure buildings are designed and sited to:
  - i) provide privacy between neighbours and between occupants and the public
  - ii) provide adequate light and natural ventilation between dwellings
  - iii) provide opportunities for additional landscaping and to deliver quality open space
  - iv) enhance the streetscape character in existing areas
  - v) establish appropriate and attractive streetscapes in new residential areas
- c) To ensure the amenity of surrounding properties is optimised, particularly in relation to privacy, overshadowing and solar access
- d) To provide a staging plan for Inner North Canberra to enable efficient and effective redevelopment to occur

Rules	Criteria
<b>2.1 Restrictions on Use – Staging of Development - Inner North Canberra</b>	
R21 Development of land in the RZ4 zone north of Macarthur Avenue and Wakefield Avenue is restricted in height to 2 storeys and a maximum plot ratio of 65%, until 23.5 hectares of residential blocks in the RZ4 Zone south of this line have been developed for multi-unit housing.	This is a mandatory requirement. There is no applicable criterion.
<b>2.2 Height</b>	
R22 Buildings do not exceed 3 storeys.	This is a mandatory requirement. There is no applicable criterion.
<b>2.3 Building Envelope</b>	
R23 Buildings are sited wholly within the building envelope defined by: a) Blocks that are the north facing boundary of an adjoining residential block: i) within the <i>primary building zone (PBZ)</i> , planes projected at 45 degrees above horizontal from a height of 2 m above natural ground level at the side boundaries, up to a maximum building	C23 The built form does not adversely impact on the amenity of neighbouring properties by ensuring: a) sufficient spatial separation between adjoining developments b) the protection of a reasonable amount of privacy and solar access to adjacent dwellings and their associated private open space.

Rules	Criteria
<p>height of 12 m above natural ground level</p> <p>ii) within the <i>rear zone (RZ)</i>, planes projected at 30 degrees above horizontal from a height of 2 m above natural ground level at the side and rear boundaries, up to a maximum height of 12 m above natural ground level.</p> <p>b) for all other side and rear boundaries:</p> <p>i) within the <i>primary building zone (PBZ)</i>, planes projected at 45 degrees above horizontal from a height of 3.5 m above natural ground level at the side boundaries, up to a maximum building height of 12 m</p> <p>ii) within the <i>rear zone (RZ)</i>, planes projected at 30 degrees above horizontal from a height of 3.5 m above natural ground level at the side and rear boundaries, up to a maximum of 12 m above natural ground level.</p>	
<b>2.4 Plot Ratio</b>	
<p>R24</p> <p>Maximum plot ratio does not exceed 80%.</p>	<p>This is a mandatory requirement. There is no applicable criterion.</p>

Note. Where a maximum plot ratio is specified the gross floor area of the development used in the calculation of the plot ratio shall be taken to be the gross floor area of the buildings plus 18m<sup>2</sup> for each roofed open car space or car port provided to meet Territory requirements for resident car parking (not including basement car parking) and the area of any balcony that is roofed and substantially enclosed by solid walls.

## Part A(5) - RZ5 – High Density Residential Zone

### Element 2: Building and Site Controls

#### Intent:

- a) To ensure buildings are designed and sited to:
  - i) provide privacy between neighbours and between occupants and the public
  - ii) provide adequate light and natural ventilation between dwellings
  - iii) provide opportunities for additional landscaping and to deliver quality open space
  - iv) enhance the streetscape character in existing areas
  - v) establish appropriate and attractive streetscapes in new residential areas
- b) To ensure the amenity of surrounding properties is optimised, particularly in relation to privacy, overshadowing and solar access

Rules	Criteria
<b>2.1 Height</b>	
<p>R25</p> <p>Buildings do not exceed 3 storeys.</p> <p><u>Exception:</u> The restriction on height does not apply to:</p> <ul style="list-style-type: none"> <li>a) Kingston/Griffith Section 25 Block 12 and Section 26 Block 47</li> <li>b) Belconnen Section 66, Section 67 Block 3, and part Block 2, and Section 88 part Block 1</li> <li>c) Belconnen Section 55 Block 37</li> </ul>	<p>C25</p> <p>Buildings to be limited in height to ensure compatibility with adjacent development and may include a basement and/or an attic.</p>
<p>R26</p> <ul style="list-style-type: none"> <li>a) Buildings do not exceed RL 609.3 ADH in Kingston/Griffith Section 25 Block 12 and Section 26 Block 47</li> </ul>	<p>C26</p> <p>Buildings on these blocks in Kingston/Griffith are predominantly three storeys, with a maximum height of four storeys where it is not the dominant feature of the street frontage.</p>

<p>There is no applicable rule.</p>	<p>C27</p> <p>Buildings are, in:</p> <ul style="list-style-type: none"> <li>a) Belconnen Section 66, Section 67, Block 3, part Block 2, and Section 88, part Block 1, predominantly three storeys, with a maximum of five storeys on parts of the Sections.</li> <li>b) Belconnen Section 55 Block 37, predominantly three storeys; however, taller buildings may be allowed where it is demonstrated that they will not create undesirable environmental conditions and will be of high architectural quality.</li> </ul>
-------------------------------------	--

## Part B - General Development Controls

This Part of the Code provides the general controls that are applicable to all development subject to this Code. Parts A and C of the Code also apply.

### Element 1: Restrictions on Use

**Intent:**

- a) To ensure future development can be accommodated on subdivided blocks

Rules	Criteria
<b>1.1 Subdivision of Existing Residential Leases (except RZ1 Zone)</b>	
<p>R28</p> <ul style="list-style-type: none"> <li>a) Subdivision (including consolidation) is not permitted unless the subdivision is part of an integrated housing development and it is demonstrated that any building on a consequent lease is or can be designed in accordance with the relevant section of this code</li> <li>b) Subdivision of a lease under the Unit Titles Act 2001 is permitted where the lease expressly provides for the number of units or dwellings provided for in the proposed subdivision.</li> </ul> <p>Note: Subdivision does not include a minor boundary adjustment that does not provide for the creation of an additional residential lease of this code.</p>	<p>This is a mandatory requirement. There is no applicable criterion.</p>

### Element 2: Building and Site Controls

**Intent:**

- a) To ensure buildings are compatible with, and complement, the built form, siting and scale of surrounding properties and are of an appropriate residential character
- b) To ensure buildings are designed and sited to:
  - i) provide privacy between neighbours and between occupants and the public
  - ii) provide adequate light and natural ventilation between dwellings
  - iii) provide opportunities for additional landscaping and to deliver quality open space
  - iv) maintain or enhance the streetscape character in existing areas
  - v) establish appropriate and attractive streetscapes in new residential areas
- c) To ensure the amenity of surrounding properties is maintained, particularly in relation to privacy, overshadowing and solar access

Rules	Criteria
<b>2.1 Demolition</b>	
<p>R29</p> <p>In accordance with section 148 of the <i>Planning and Development Act 2007</i>, the application is accompanied by a Statement of Endorsement for utilities (including Water, Sewerage, Stormwater, Electricity and Gas) stating that:</p> <ul style="list-style-type: none"> <li>a) all network infrastructure on or immediately adjacent the site has been identified on the plan</li> <li>b) all potentially hazardous substances and conditions (associated with or resulting from the demolition process) that may constitute a risk to utility services have been identified</li> <li>c) all required network disconnections have been identified and the disconnection works comply with utility requirements</li> <li>d) all works associated with the demolition comply with and are in accordance with utility asset access and protection requirements.</li> </ul>	<p>C29</p> <p>If a Statement of Endorsement is not provided, the application will be referred to relevant utilities in accordance with the requirements of the <i>Planning and Development Act 2007</i>.</p>
<b>2.2 National Capital Plan Requirements</b>	
<p>There is no applicable rule.</p>	<p>C30</p> <p>Where a development is subject to Special Requirements under the National Capital Plan (including any relevant Development Control Plan) the development is not inconsistent with the Special Requirements.</p>
<b>2.3 Estate Development Plans approved prior to 31 March 2008</b>	
<p>R31</p> <p>The development proposal complies with any relevant approved lease and development conditions for the Estate Development Plan.</p>	<p>There is no applicable criterion.</p>
<b>2.4 Estate Development Plans approved post 31 March 2008</b>	
<p>R32</p> <p>The development proposal complies with any relevant rule in the relevant Precinct Code (if any).</p>	<p>There is no applicable criterion.</p>



Rules	Criteria
<b>2.5 Height</b>	
There is no applicable rule.	<p>C33</p> <p>Notwithstanding any other provision relating to height, on land where a lawfully constructed building exceeds two storeys in height, a new building or buildings up to the height of the existing building may be permitted subject to consideration of any adverse impact resulting from any increase in building bulk.</p>
<b>2.6 Plot Ratio</b>	
There is no applicable rule.	<p>C34</p> <p>Notwithstanding any other provision relating to plot ratio, on land where a lawfully constructed building exceeds the stipulated maximum plot ratio, a new building or buildings up to the same plot ratio may be permitted:</p> <p>a) subject to consideration of any adverse impact resulting from increase in building bulk</p> <p>b) if, and only if, the development does not involve an increase in the number of dwellings on the land.</p>

Note. Where a maximum plot ratio is specified the gross floor area of the development used in the calculation of the plot ratio shall be taken to be the gross floor area of the buildings plus 18m<sup>2</sup> for each roofed open car space or car port provided to meet Territory requirements for resident car parking (not including basement car parking) and the area of any balcony that is roofed and substantially enclosed by solid walls.

### Element 3: Built Form

#### Intent:

- a) To provide safe and accessible neighbourhoods

Rules	Criteria
<b>3.1 Crime Prevention Through Environmental Design</b>	
There is no applicable rule.	<p>C35</p> <p>The development meets the requirements of the Crime Prevention Through Environmental Design General Code.</p>

Rules	Criteria
<b>3.2 Access and Mobility</b>	
There is no applicable rule.	C36 The development meets the requirements of the Access and Mobility General Code.

#### Element 4: Parking and Site Access

**Intent:**

- a) To ensure traffic generation and parking are considered as part of the overall design of the development

Rules	Criteria
<b>4.1 Traffic Generation</b>	
There is no applicable rule.	C37 The existing road network can accommodate the amount of traffic that is likely to be generated by the development.
<b>4.2 Parking</b>	
There is no applicable rule.	C38 Car and bicycle parking complies with the requirements of the Parking and Vehicular Access General Code and AS 2890.1 – <i>The Australian Standard for Off-Street Parking</i> and the Bicycle Parking General Code.

#### Element 6: Environment

**Intent:**

- a) To identify and mitigate potential on-site and off-site environmental impacts of development and incorporate alternative design options where necessary
- b) Buildings are designed to provide for the retention of existing significant vegetation and minimise impact on landform
- c) To ensure preservation of areas, or items, of heritage significance that are valued by the community
- d) To encourage harvesting of rainwater and the efficient use of water resources
- e) Note: Refer to the Water Ways: Water Sensitive Urban Design General Code for more information on Water Sensitive Urban Design

Rules	Criteria
<b>6.1 Heritage</b>	
<p>R39</p> <p>In accordance with section 148 of the <i>Planning and Development Act 2007</i>, applications for developments on land or buildings subject to interim or full heritage registration are accompanied by advice from the Heritage Council stating that the development meets the requirements of the <i>Heritage Act 2004</i>.</p>	<p>C39</p> <p>If advice from the Heritage Council is required, but not provided, then the application will be referred to the Heritage Council in accordance with the requirements of the <i>Planning and Development Act 2007</i>.</p>
<b>6.2 Trees</b>	
<p>R40</p> <p>In accordance with section 148 of the <i>Planning and Development Act 2007</i>, where the development proposal requires groundwork within the tree protection zone of a protected tree, or is likely to cause damage to or removal of, any protected trees, the application is accompanied by a Tree Management Plan approved under the <i>Tree Protection Act 2005</i>.</p> <p>Note: 'Protected tree' is defined under the <i>Tree Protection Act 2005</i>.</p>	<p>C40</p> <p>If an approved Tree Management Plan is required, but not provided, then a draft Tree Management Plan is to accompany the application. The draft Tree Management Plan will be referred to the relevant agency in accordance with the requirements of the <i>Planning and Development Act 2007</i>.</p>
<b>6.3 Hazardous Materials</b>	
<p>R41</p> <p>For the demolition of multi-unit housing (including garages and carports) constructed* prior to 1985, and Commercial / Industrial premises constructed prior to 2005, a Hazardous Materials Survey (including an asbestos survey) is carried out and signed by an appropriately licensed person and is endorsed by Environment Protection.</p> <p>The Survey is provided and covers the disposal of hazardous materials, showing that:</p> <p>a) Hazardous material disposal (including asbestos) is to be at a licensed disposal facility in the ACT</p> <p>b) If hazardous materials are to be transported for disposal interstate, approval from the Environment Protection Authority is obtained prior to removal of material from the site</p> <p>c) An appropriately licensed contractor is engaged for the removal and transport of all hazardous materials (including asbestos) present at the site.</p> <p>* construction date means the date when the Certificate of Occupancy was issued</p>	<p>C41</p> <p>If an endorsed Hazardous Materials Survey is not provided the application will be referred to the relevant agency in accordance with the requirements of the <i>Planning and Development Act 2007</i>.</p>

Rules	Criteria
<b>6.4 Contamination</b>	
<p>R42</p> <p>A statement is provided that the potential for land contamination has been assessed in accordance with the <i>ACT Government Strategic Plan – Contaminated Sites Management 1995</i> and the <i>ACT Environment Protection Authority Contaminated Sites Environmental Protection Policy 2000</i>, and it is demonstrated that the land is suitable for the proposed development.</p>	<p>C42</p> <p>If a statement that the site has been assessed is not provided, the application will be referred to the relevant agency in accordance with the requirements of the <i>Planning and Development Act 2007</i>.</p>
<b>6.5 Erosion and Sediment Control</b>	
<p>R43</p> <p>For sites less than 0.3 of a hectare, a plan is provided to demonstrate that the development complies with the <i>ACT Environment Protection Authority, Environment Protection Guidelines for Construction and Land Development in the ACT, August 2007</i>.</p>	<p>C43</p> <p>If a plan is not provided, the application will be referred to the relevant agency in accordance with the requirements of the <i>Planning and Development Act 2007</i>.</p>
<p>R44</p> <p>For development on a site greater than 0.3 of a hectare, the application is accompanied by an Erosion and Sediment Control Plan endorsed by the ACT Environment Protection Authority.</p>	<p>C44</p> <p>If an endorsed Sediment and Erosion Control Plan is not provided the application will be referred to the relevant agency in accordance with the requirements of the <i>Planning and Development Act 2007</i>.</p>
<b>6.6 Signs</b>	
<p>There is no applicable rule.</p>	<p>C45</p> <p>Signs comply with the Signs General Code.</p>
<b>6.7 Water Sensitive Urban Design – Mains Water Consumption</b>	
<p>R46</p> <p>Evidence is provided that shows the development achieves a minimum 40% reduction in mains water consumption compared to an equivalent development constructed in 2003 using the ACTPLA on-line assessment tool or the NSW BASIX tool. The 40% target is met without any reliance on landscaping measures to reduce consumption.</p>	<p>This is a mandatory requirement. There is no applicable criterion.</p>

Rules	Criteria
<b>6.8 Water Sensitive Urban Design – Stormwater Quality</b>	
<p>R47</p> <p>Evidence is provided that demonstrates that for developments on sites &lt;2000m<sup>2</sup>, a reduction of 1-in-3 month stormwater peak run off flow to pre-development levels with release of captured flow over a period of 1 to 3 days can be achieved.</p>	<p>This is a mandatory requirement. There is no applicable criterion.</p>
<p>R48</p> <p>Evidence is provided that demonstrates that for developments on sites &gt;2000m<sup>2</sup>, a reduction in average annual stormwater pollutant export load of:</p> <ul style="list-style-type: none"> <li>a) suspended solids by 60%</li> <li>b) total phosphorous by 45%</li> <li>c) total nitrogen by 40%</li> </ul> <p>using the MUSIC model to demonstrate compliance.</p>	<p>C48</p> <p>For developments on sites &gt;2000m<sup>2</sup> the development is demonstrated to achieve a reduction in average annual stormwater pollutant export load of:</p> <ul style="list-style-type: none"> <li>a) suspended solids by 60%</li> <li>b) total phosphorous by 45%</li> <li>c) total nitrogen by 40%</li> </ul> <p>compared to an urban catchment with no water quality management controls, using any other method, eg XP-AQUALM, PURRS, Aquacycle, that can demonstrate, to the satisfaction of the Authority, compliance.</p>
<b>6.9 Water Sensitive Urban Design – Stormwater Quantity</b>	
<p>R49</p> <p>Evidence is provided that shows the development achieves:</p> <ul style="list-style-type: none"> <li>a) a reduction of 1-in-3 month stormwater peak run off flow to pre-development levels with release of captured flow over a period of 1 to 3 days.</li> <li>b) A reduction of 1-in-5 year and 1-in-100 year stormwater peak run off flow to pre-development levels</li> </ul> <p>using XP-RAFTS, DRAINS (ILSAX), RORB or WBNM models to demonstrate compliance.</p>	<p>This is a mandatory requirement. There is no applicable criterion.</p>

## Element 7: Services

### Intent:

- a) To ensure adequate provision of services to cater for demand from residents
- b) To protect easements and service reservations

Rules	Criteria
<b>7.1 Waste Management</b>	
<p>R50</p> <p>In accordance with section 148 of the <i>Planning and Development Act 2007</i>, the applications is accompanied by a Statement of Compliance from the Department of Territory and Municipal Services stating that the waste facilities and management associated with the development are in accordance with the <i>Development Control Code for Best Practice Waste Management in the ACT 1999</i>.</p>	<p>C50</p> <p>If a Statement of Compliance is not provided, the application will be referred to the Department of Territory and Municipal Services in accordance with the requirements of the <i>Planning and Development Act 2007</i>.</p>
<b>7.2 Servicing and Site Management</b>	
<p>R51</p> <p>In accordance with section 148 of the <i>Planning and Development Act 2007</i>, the application is accompanied by a Statement of Endorsement from the relevant agency stating that the waste facilities and management associated with the development are in accordance with the <i>Design Standards for Urban Infrastructure</i>.</p>	<p>C51</p> <p>If a Statement of Endorsement is not provided the application will be referred to the relevant agency in accordance with the requirements of the <i>Planning and Development Act 2007</i>.</p>
<b>7.3 Utilities</b>	
<p>R52</p> <p>A Statement of Compliance from each relevant utility provider (for water, sewerage, stormwater, electricity and gas) is provided, which confirms that the location and nature of earthworks, utility connections, proposed buildings, pavements and landscape features comply with utility standards, access provisions and asset clearance zones.</p> <p>Note: Where there is a conflict between planning and utility requirements, the utility requirements take precedence over other codified or merit provisions.</p>	<p>C52</p> <p>If a Statement of Compliance is not provided the application will be referred to the relevant agency in accordance with the requirements of the <i>Planning and Development Act 2007</i>.</p>
<p>R53</p> <p>a) Electricity supply lines within existing residential areas are underground or along the rear spine or side of blocks.</p> <p>b) No continuous rows of electricity supply poles are erected on residential streets or streets with residential access.</p>	<p>This is a mandatory requirement. There is no applicable criterion.</p>

## Part C - Development Type Controls

This part of the Code provides the controls for multi unit housing. It is divided into five sub-parts.

Part C(1) provide the controls for multi unit housing in all residential zones, except where provided for by Parts C(2) - C(5). As such, it is the default position for multi unit housing.

Part C(2) provide additional controls to, or controls that are to be applied in lieu of, those in Part C(1) for multi unit housing in parts of Deakin and Forrest due to the distinctive environmental quality of these historic Sections of South Canberra. This Part applies to Deakin, Sections 5-8 and Forrest, Sections 20-22 and 26-27.

Part C(3) provide the controls for multi unit housing in the RZ3 - Urban Residential and RZ4 – Medium Density Residential Zones in Inner North Canberra and the Gungahlin District.

Part C(4) provide the controls for multi unit housing in excess of 2 storeys in the RZ5 – High Density Residential Zone as it applies to Kingston and Griffith.

Part C(5) – provide the controls for multi unit housing in the other RZ4 – Medium Density Residential and RZ5 – High Density Residential Zones as they apply in Belconnen, Bruce, Hawker, Narrabundah, Woden District and Tuggeranong District. It also applies to multi unit housing in the Commercial Zones.

### Part C(1) - Multi Unit Housing

This section of the code applies to development applications for multi unit housing in all residential zones, except where provided for by Parts C(2) - C(5). As such, it is the default position for multi unit housing. It is to be read in conjunction with Parts A and B.

#### Element 2: Building and Site Controls

##### Intent:

- a) To ensure buildings are compatible with, and complement, the built form, siting and scale of surrounding properties and are of an appropriate residential character
- b) To ensure buildings are designed and sited to:
  - i) provide privacy between neighbours and between occupants and the public
  - ii) provide adequate light and natural ventilation between dwellings
  - iii) provide opportunities for additional landscaping and to deliver quality open space
  - iv) maintain or enhance the streetscape character in existing areas
  - v) establish appropriate and attractive streetscapes in new residential areas
- c) To ensure the amenity of surrounding properties is maintained, particularly in relation to privacy, overshadowing and solar access

Rules	Criteria
<b>2.1 Front Street Setback</b>	
R54 Front setbacks are as specified in Tables 1 and 2. Refer also to Figure C1.	C54 The front setback: <ul style="list-style-type: none"> <li>a) reflects the existing or proposed streetscape character</li> <li>b) provides for the most efficient use of the site</li> <li>c) will not significantly compromise the amenity of residents of the proposed building and residents of adjoining and adjacent dwellings</li> <li>d) is related to the height of the building and to the width of the street to ensure pedestrian scale at street level</li> <li>e) space is provided for street trees to grow to maturity</li> <li>f) parking and garages do not dominate the frontage of the development.</li> </ul>

**Table 1: Front Street Setback** (refer Figure C1)

Floor level	Land originally developed after 18 October 1993	Land originally developed before 18 October 1993	Exceptions		
			Corner blocks		Open space or pedestrian paths wider than 6m
			<500 m <sup>2</sup> , long street frontage	≥500 m <sup>2</sup> , long street frontage	
Lower floor level	4 m	6 m	3 m	4 m	4 m
Upper floor level	6 m	7.5 m	3 m	6 m	4 m

Notes: The minimum setbacks for corner blocks apply only to the street frontage nominated. Setbacks to any other street frontage are to comply with the minimum requirements stated in the respective columns for land developed post or pre 18 October 1993. If street frontages on corner blocks are of equal length, the minimum setbacks only apply to one street frontage.



**Table 2: Front Street Setback to Garages** (refer Figure C1)

Item	Land developed after 18 October 1993	Land developed before 18 October 1993
Garage	5.5 m with a minimum of 1.5 m behind the front building line	6 m

Rules	Criteria
<b>2.2 Side Setback</b>	
R55 Side setbacks are as specified in Tables 3 to 4. Refer also to Figure C1 and Definitions for a dictionary of terms used in the Tables.	C55 a) Buildings and other structures are sited and reflect residential (suburban) scale, height and length to ensure:  i) sufficient spatial separation between adjoining developments  ii) the protection of a reasonable amount of privacy and solar access to the dwelling (or adjacent dwellings) and outdoor spaces (or adjacent outdoor spaces).  b) Setbacks are progressively increased as wall heights increase to reduce bulk and scale of the building.

**Table 3: Side Setback for Lower Floor Level** (refer Figure C1)

	Side boundary 1	Side boundary 2
Lower floor level	3 m	3 m

Note: Minimum side setback requirements apply to buildings and Class 10 structures, except for Boundary 2, where the minimum side setback for Class 10 structures is 1.5 m.

**Table 4: Side Setback for Upper Floors** (refer Figure C1)

Floor Level	Side boundary 1 within the Primary Building Zone (PBZ)	Side boundary 2 within the Primary Building Zone (PBZ)	Side boundaries within the Rear Zone (RZ)
Upper floor level*	3 m	3m	6 m
Upper floor level**	6 m	6m	9 m

\* Where design incorporates blank walls, windows with sill heights  $\geq 1.7$  m from the floor or windows with permanently fixed panes of obscure glass.

\*\* Where design incorporates other walls, outer faces or unscreened decks, balconies and external stairs.

Rules	Criteria
<b>2.3 Rear Setback</b>	
<p>R56</p> <p>Rear setbacks are a minimum of:</p> <ul style="list-style-type: none"> <li>a) 3 m to the lower floor level</li> <li>b) 6 m* or 9 m** to the upper floor level.</li> </ul> <p>Refer also to Figure C1.</p> <p>* Where design incorporates blank walls, windows with sill heights <math>\geq 1.7</math> m from the floor or windows with permanently fixed panes of obscure glass.</p> <p>** Where design incorporates other walls, outer faces or unscreened decks, balconies and external stairs.</p>	<p>C56</p> <p>Buildings and other structures are sited and reflect residential (suburban) scale, height and length to ensure:</p> <ul style="list-style-type: none"> <li>a) sufficient spatial separation between adjoining developments</li> <li>b) the protection of a reasonable amount of privacy and solar access to the dwelling (or adjacent dwellings) and outdoor spaces (or adjacent outdoor spaces).</li> </ul>

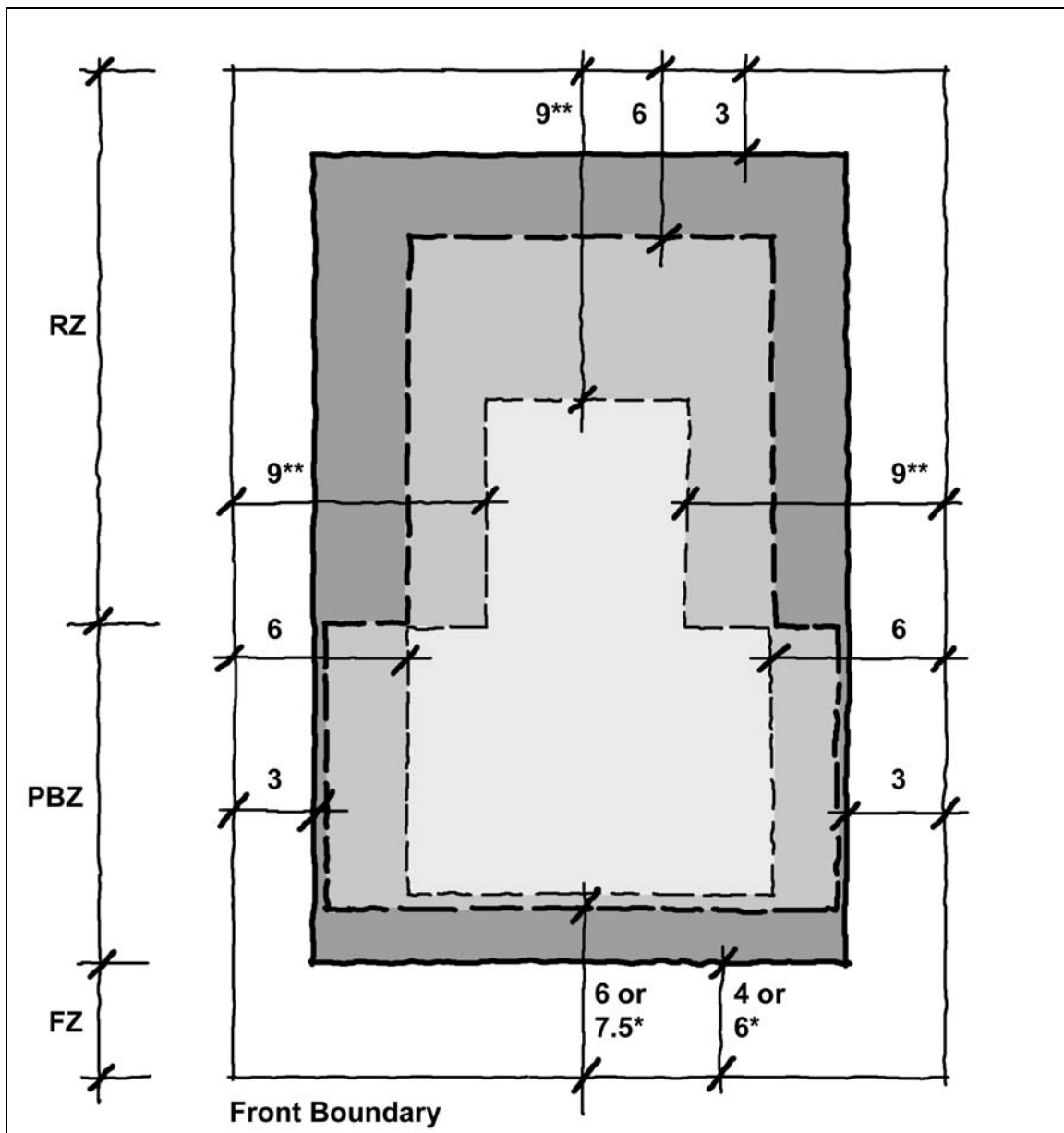





Figure 4 Setbacks

	Lower Floor Level Setbacks	
	Upper Floor Level Setbacks	Where the design incorporates blank walls, windows with sill heights > 1.7m or windows with permanently fixed panes of obscure glass.
	Upper Floor Level Setbacks	** Where the design incorporates other walls, outer faces or unscreened decks, balconies and external stairs.
* Front setbacks on blocks approved prior to 18 October 1993.		

### Element 3: Built Form

#### Intent:

- To ensure that the design of buildings complement the built form of surrounding properties
- To allow flexibility in design and use of materials and colours and encourage high quality architectural standards that contribute to visually harmonious and attractive streetscapes
- To ensure that rear and side fencing will assist in providing privacy to open space areas
- To ensure that the design of buildings provides visual variety and interest within overall harmony with surrounding development

Note: Under the *Building Act 2004* most buildings need to meet the requirements of the Building Code of Australia. For certain classes of buildings, this will include prescribed energy requirements.

Rules	Criteria
<b>3.1 Building Design</b>	
<p>R57</p> <p>There is a maximum of 15 m of unarticulated walls in buildings that contain more than two dwellings. Wall articulation is provided by:</p> <ol style="list-style-type: none"> <li>changes in wall planes of a minimum 1.0 m in depth and 4.0 m in length</li> <li>OR</li> <li>inclusion of balconies, fin walls, etc.,</li> <li>OR</li> <li>horizontally stepping facades by at least 1.0 m</li> </ol>	<p>C57</p> <p>Building design, articulation, detailing and finish provide an appropriate scale, add visual interest and enable visual differentiation between dwellings when viewed from public streets.</p>
<b>3.2 Materials and Finish</b>	
<p>R58</p> <p>Metal roofing and/or metal walling is painted or pre-coloured other than in white or off-white. A</p>	<p>C58</p> <p>Roofing and/or wall finish to avoid glare.</p>

Rules	Criteria
<p>finish is white or off-white when, compared to <i>Australian Standard AS 2700 – Colour Standards for General Purposes</i>, the colour which under that standard that most closely matches the finish is any of the following colour codes or names under that standard:</p> <ul style="list-style-type: none"> <li>a) Y31 (Lily Green), Y33 (Pale Primrose), or Y35 (Off White);</li> <li>b) X33 (Warm White);</li> <li>c) R32 (Apple Blossom), R33 (Ghost Gum);</li> <li>d) B33 (Mist Blue), or B35 (Pale Blue)</li> <li>e) G42 (Glacier);</li> <li>f) N14 (White).</li> </ul>	
<p>There is no applicable rule.</p>	<p>C59</p> <p>In established residential areas, external materials and colours are respectful of the surrounding built form.</p>
<p>R60</p> <p>Structures and plant and equipment situated on the roof is not visible from the street frontage or unleased territory land unless exempt under <i>Planning and Development Act 2007</i>. This includes water tanks, solar energy devices, evaporative cooling or air conditioning devices, a radio mast or aerial, or a satellite dish.</p>	<p>C60</p> <p>Any structures and plant and equipment situated on or visible above the roofline is as inconspicuous as possible or does not significantly impact on the amenity of the streetscape or neighbours.</p>
<p>R61</p> <p>Garages and carports within 15 m of the front boundary are constructed with the same material as the corresponding elements of the dwelling.</p>	<p>C61</p> <p>The construction of garages and carports are compatible with the dwelling design in terms of materials and colours.</p>
<p>R62</p> <p>No externally exposed plumbing attached to building walls.</p>	<p>This is a mandatory requirement. There is no applicable criterion.</p>
<p><b>3.3 Interface</b></p>	
<p>R63</p> <p>Free standing walls or fencing are not permitted forward of the building line except where one or more of the following apply:</p> <ul style="list-style-type: none"> <li>a) previously approved in an estate development plan</li> <li>b) consistent with an relevant precinct code</li> <li>c) it is a gate to a maximum height of 1.8m in an established, vigorous hedge</li> </ul>	<p>C63</p> <p>Fences may be permitted where the proposal meets the requirements contained in the Residential Boundaries Fences General Code.</p>

Rules	Criteria
d) it is a courtyard wall that meets the requirements of R62/C62, C63 and R64/C64.	
<p>R64</p> <p>Courtyard walls forward of the building line have:</p> <ul style="list-style-type: none"> <li>a) a total length not exceeding 50% of the width of the block, or 70% in the case of blocks less than 12m wide, at the line of the wall</li> <li>b) a minimum setback from the front boundary of not less than 50% of the minimum front street setback</li> <li>c) a maximum height not exceeding 1.8m</li> <li>d) brick, block or stonework construction, any of which may be combined with feature panels</li> <li>e) the area between the wall and the front boundary planted with shrubs</li> <li>f) courtyard walls do not obstruct site lines for vehicles and pedestrians on public paths on driveways in accordance with A2890.1- <i>The Australian Standard for Off-Street Parking</i>.</li> </ul>	<p>C64</p> <ul style="list-style-type: none"> <li>a) Courtyard walls forward of the building line may be considered where the existing front building facade is maintained as the dominant built element in the streetscape.</li> <li>b) The courtyard wall reads as a secondary built element of appropriate proportions and character with respect to: <ul style="list-style-type: none"> <li>i) height</li> <li>ii) relationship to verge footpath</li> <li>iii) total proportion relative to the building width</li> <li>iv) colour and design features</li> <li>v) transparency and articulation</li> <li>vi) protection of existing desirable landscape features</li> <li>vii) tree and shrub planting forward of the wall</li> </ul> </li> <li>c) courtyard walls do not obstruct sight lines for vehicles and pedestrians on public paths or driveways in accordance with AS2890.1- <i>The Australian Standard for Off-Street Parking</i>.</li> </ul>
There is no applicable rule.	<p>C65</p> <p>Courtyard walls do not detract from the established character of the street.</p>
<p>R66</p> <ul style="list-style-type: none"> <li>a) The design and siting of courtyard walls include breaks or indents every 15 m, the indents are not less than 1 m in depth and 4 m in length, the indented area is directly accessible from within the block and, together with any area between the wall and the front boundary, is planted in accordance with an approved landscape plan.</li> <li>b) Courtyard walls are constructed of brick, block or stonework.</li> </ul>	<p>C66</p> <p>Courtyard walls are designed and detailed to provide visual interest to the streetscape and provide for landscaping to reduce their scale and soften the visual impact of the wall surfaces.</p>

Rules	Criteria
<p>R67</p> <p>Fences are permitted in accordance with the <i>Common Boundaries Act 1981</i>.</p>	<p>This is a mandatory requirement. There is no applicable criterion.</p>
<p>R68</p> <p>a) The minimum interfacing distance between blank walls is:</p> <p>i) at least 3 m between walls of facing dwellings at lower floor level, where the external wall of the other dwelling is blank and is not located to the north, north-east or north-west of the first dwelling. This distance is a minimum of 6 m at upper floor levels</p> <p>ii) 1 m where the external blank wall is located to another orientation, and where a party wall is not provided between dwellings.</p> <p>b) The minimum interfacing distance between walls that are not blank is:</p> <p>i) at least 6 m between walls of facing dwellings, where there are balconies, unscreened decks or windows (other than windows with permanently fixed panes of obscure glass), or glazed doors to a habitable room facing another dwelling and where a screen wall is provided between the dwellings. This distance is a minimum of 12 m where no screen wall is provided and at upper floor levels</p> <p>ii) at least 1.5 m between walls of facing dwellings at lower floor level, where there are windows of other than habitable rooms or where windows with permanently fixed panes of obscure glass face one another. This distance is a minimum of 3 m at upper floor levels.</p>	<p>C68</p> <p>The dwellings are to be designed and located to:</p> <p>a) receive adequate daylight and sunlight</p> <p>b) protect the living rooms of adjacent dwellings from direct overlooking.</p>
<p>R69</p> <p>Outlook from windows, balconies, stairs, landings and decks or other private, communal or public areas within a development are designed, screened or obscured to prevent overlooking of more than 50% of the private open space of another dwelling on the same block</p>	<p>C69</p> <p>Direct overlooking of private open spaces of other dwellings is limited by building layout, location and design of windows and balconies, screening devices and landscape, or remoteness.</p>

Rules	Criteria
<b>3.4 Accessibility (mobility)</b>	
R70 10% of the dwellings of any multi-unit housing development consisting of 10 or more dwellings are designed to meet the relevant Australian Standard and any relevant considerations in the Access and Mobility General Code.	This is a mandatory requirement. There is no applicable criterion.

#### Element 4: Parking and Site Access

##### Intent:

- a) To encourage design of access and parking as part of the overall design of the development
- b) To provide sufficient, convenient, accessible and safe parking to meet the needs of the residents and visitors
- c) To ensure that parking facilities do not detract from streetscape amenity and surveillance of the street
- d) To ensure that parked vehicles do not obstruct the passage of vehicles on the carriageway or create traffic hazards

Rules	Criteria
<b>4.1 Vehicle Access</b>	
R71 There is one driveway and kerb crossing for each block.	C71 Provided all other rules in this element are met, more than one driveway and kerb crossing over the verge may be permitted for: <ol style="list-style-type: none"> <li>a) forward entry to roads carrying greater than 3000 vpd; or</li> <li>b) large blocks where the visual impact to the streetscape is not adversely affected, provided the site access is of appropriate proportions and character with respect to: <ol style="list-style-type: none"> <li>i) relationship to verge footpath</li> <li>ii) total proportion of the width of the access relative to the building width</li> <li>iii) design features</li> <li>iv) protection of existing landscape features.</li> </ol> </li> </ol>
R72 The location and design of residential driveway verge crossings are: <ol style="list-style-type: none"> <li>a) 1.2 m horizontally clear of stormwater sumps and other services</li> <li>b) 1.5 m horizontally clear of transformers, bus stops, public light poles</li> </ol>	C72 If the development proposal does not comply with R70 the application will be referred to the Department of Territory and Municipal Services in accordance with the requirements of the <i>Planning and Development Act 2007</i> .

Rules	Criteria
<ul style="list-style-type: none"> <li>c) 6.0 m horizontally clear of the tangent point of the radius of the curve on a corner block (excluding locations with roundabouts and signalised intersections, which require separate formal approval and support from Asset Acceptance)</li> <li>d) uphill grade of less than 17%; downhill grade of less than 12%</li> <li>e) at a right angle to the kerb line with a maximum 10% deviation</li> <li>f) a maximum of 5.5 m width, and a minimum of 5 m width at the kerb, a minimum 3 m width at the front boundary, and a maximum width no greater than the width at the kerb</li> <li>g) outside of the drip line of mature trees, and a minimum of 3 m clear of small and new street trees</li> <li>h) compliant with AS 2890.1 - <i>The Australian Standard for Off Street Parking</i>, having particular regard for sightlines and cross fall of the site.</li> </ul>	
<p>R73</p> <p>Where there is a paved pathway in the verge the pathway material is continuous and not interrupted by the driveway.</p>	<p>This is a mandatory requirement. There is no applicable criterion.</p>
<p>There is no applicable rule.</p>	<p>C74</p> <p>Service areas and setdown arrangements provide for the efficient operations of the development whilst protecting residential amenity and avoiding impacts on adjoining streets.</p>
<p>R75</p> <p>Individual parking spaces are accessed from a common driveway or access/internal road in a development of more than two dwellings.</p>	<p>C75</p> <p>Vehicular access and car parking to be located and designed to maintain streetscape amenity and allow safe and efficient vehicle movement.</p>
<p>R76</p> <p>In relation to driveways and access/internal roads:</p> <ul style="list-style-type: none"> <li>a) shared driveways and access/internal roads are separated from the side boundary and building frontages by an area of planting that is a minimum width of 1.5 m</li> <li>b) the minimum width of driveways and access/internal roads is 3 m</li> </ul>	<p>C76</p> <p>Driveways and access/internal roads allow safe and efficient vehicle movement and good connections to the existing street network as well as providing a high quality pedestrian priority environment.</p>



Rules	Criteria
<p>c) where there are changes in direction or intersections, the internal radius of the driveway and access/internal road is at least 4 m</p> <p>d) where four or more car spaces are served or a driveway or access road connects to a public road, manoeuvring space is provided to ensure vehicles can enter and exit the site in a forward direction</p> <p>e) where more than 10 car spaces are served and the driveway or access/internal road connects to a public road, the entrance is at least 5 m wide for a distance of 7 m from the street front boundary to allow vehicles to pass each other.</p>	
<p>R77</p> <p>a) Driveways and access/internal roads are to have minimum widths as detailed below for the corresponding angle parking:</p> <ul style="list-style-type: none"> <li>i) 45 degree parking: 3.5 m</li> <li>ii) 60 degree parking: 4.9 m</li> <li>iii) 90 degree parking: 6.4 m</li> <li>iv) parallel parking: 3.6 m</li> </ul> <p>b) In the case of 90 degree angle parking, the width of the driveway or access road can be reduced, provided that the width of car parking spaces is increased, as follows:</p> <ul style="list-style-type: none"> <li>i) for a driveway width of 5.8 m, the car-parking space width is at least 2.8 m</li> <li>ii) for a driveway width of 5.2 m, the car-parking space width is at least 3 m.</li> </ul>	<p>C77</p> <p>Access/internal roads to meet the requirements of TaMS, if waste management vehicles are required to enter the site.</p>
<p>R78</p> <p>The surface treatment of driveways and access/internal roads is distinct from car parking spaces/ and areas.</p>	<p>This is a mandatory requirement. There is no applicable criterion.</p>
<p>There is no applicable rule.</p>	<p>C79</p> <p>Driveways, access/internal roads and car parking areas are designed, surfaced and sloped to encourage and facilitate stormwater infiltration on site.</p>

Rules	Criteria
<b>4.2 Parking</b>	
<p>R80</p> <p>Car-parking spaces and areas are set back a minimum distance of:</p> <p>a) 1.5 m from any external block boundary</p> <p>b) 1.5 m from a dwelling with which it is not associated.</p>	<p>This is a mandatory requirement. There is no applicable criterion.</p>
<p>R81</p> <p>a) Car-parking spaces:</p> <p>i) can be in tandem where they belong to the same dwelling, except for visitor parking where required</p> <p>ii) do not encroach any property boundaries.</p> <p>b) One space is capable of being roofed and be behind the front zone.</p> <p>c) Minimum dimensions of on-site car parking spaces are:</p> <p>i) 6.0 x 3.0 m single roofed space</p> <p>ii) 6.0 x 5.5 m double roofed space</p> <p>iii) 5.5 x 3.0 m unroofed space (unless for multiple spaces side by side, in which case, minimum 5.5 x 2.6 m per unroofed space is required)</p> <p>iv) 6.7 x 2.3 m parallel parking spaces</p> <p>v) 2.1 m minimum height to any overhead structure</p> <p>d) Sightlines for off-street car-parking facilities are designed in accordance with the relevant requirements in AS2890.1 <i>The Australian Standard for Off Street Parking</i>.</p>	<p>C81</p> <p>Car parking complies with the requirements of the Parking and Vehicular Access General Code and ensures:</p> <p>a) the amenity of neighbouring residential areas and streetscapes is not unacceptably affected by the provision of parking and access</p> <p>b) no traffic hazards are created by the provision of access and parking facilities for a development</p> <p>c) the safety of all users, especially pedestrians and cyclists, is considered</p> <p>d) the creation of community surveillance of car parking areas by people using neighbouring areas</p> <p>e) parking generated by a development does not unacceptably affect the safe and efficient functioning of traffic and access to neighbouring areas</p> <p>f) adequate supply of parking for the level of demand generated by the development</p> <p>g) safe and efficient access for all users, with the needs of residents and visitors being catered for by the on-site provision of adequate parking.</p>
<p>R82</p> <p>Shared car parking spaces are not located more than 50 m from any dwelling they serve.</p>	<p>C82</p> <p>Car parking facilities to be designed and located to be reasonably close and convenient to dwellings.</p>
<p>R83</p> <p>Car parking spaces are not located between the front boundary and the building line</p>	<p>C83</p> <p>Parking spaces are configured to minimise their visual impact from the street and maintain streetscape amenity.</p>

Rules	Criteria
<p>R84</p> <p>The maximum width of garages and carports is 6 m, or 50% of the frontage of the dwelling, whichever is less.</p>	<p>C84</p> <p>Car parking complies with the requirements of the Parking and Vehicular Access General Code and ensures:</p> <ul style="list-style-type: none"> <li>a) the amenity of neighbouring residential areas and streetscapes is not unacceptably affected by the provision of parking and access</li> <li>b) no traffic hazards are created by the provision of access and parking facilities for a development</li> <li>c) the safety of all users, especially pedestrians and cyclists, is considered</li> <li>d) the creation of community surveillance of car parking areas by people using neighbouring areas</li> <li>e) parking generated by a development does not unacceptably affect the safe and efficient functioning of traffic and access to neighbouring areas</li> <li>f) adequate supply of parking for the level of demand generated by the development</li> <li>g) safe and efficient access for all users, with the needs of residents and visitors being catered for by the on-site provision of adequate parking.</li> </ul>
<p>R85</p> <p>Provision for vehicle parking is not permitted on verges.</p>	<p>This is a mandatory requirement. There is no applicable criterion.</p>

## Element 5: Amenity

### Intent:

- a) Development is sited and designed to maximise solar access to private open space and living areas of dwellings
- b) Dwellings are provided with private and useable private open space that is integrated with, and directly accessible from, the living areas of the dwelling
- c) To ensure landscaping creates a pleasant, safe and attractive living environment and assists to blend new development into the streetscape and neighbourhood

Rules	Criteria
<b>5.1 Solar Access</b>	
<p>R86</p> <p>Development is sited to allow a minimum of 3 hours of direct sunlight onto the floor or internal wall of the main daytime living area of the dwelling between the hours of 9.00 am and 3.00 pm on 21 June (winter solstice).</p>	<p>This is a mandatory requirement. There is no applicable criterion.</p>
<b>5.2 Neighbourhood Plans</b>	
<p>There is no applicable rule.</p>	<p>C87</p> <p>Where a Neighbourhood Plan exists, development demonstrates response to the key strategies and actions of the relevant Neighbourhood Plan.</p>
<b>5.3 Private Open Space</b>	
<p>R88</p> <p>The development provides 60% of the area of the block, less 50m<sup>2</sup>, as private open space.</p> <p>The total required area of private open space is the average area of private open space per dwelling multiplied by the proposed number of dwellings on the block.</p>	<p>C88</p> <p>Private open space is of dimensions to suit the projected requirements of the dwelling's occupants and to accommodate both outdoor recreation needs as well as providing space for service functions such as clothes drying and domestic storage.</p>
<p>R89</p> <p>At least one area of private open space is provided per dwelling to meet the following minimum area and dimension requirements:</p> <ul style="list-style-type: none"> <li>a) 10% of the area of the block</li> <li>b) 6 m x 6 m.</li> </ul>	<p>C89</p> <p>Private open space is of dimensions to suit the projected requirements of the dwelling's occupants and to accommodate both outdoor recreation needs as well as providing space for service functions such as clothes drying and domestic storage.</p>
<p>R90</p> <p>Private open space is:</p> <ul style="list-style-type: none"> <li>a) screened from public view</li> <li>b) not forward of the building line except where permitted by, and illustrated in, an approved estate development plan</li> <li>c) at ground level with direct ground level access from a main daytime living area of the dwelling</li> <li>d) located to maintain a minimum three hours sunlight onto 50% of the ground between the hours of 9.00 am and 3.00 pm on 21</li> </ul>	<p>C90</p> <ul style="list-style-type: none"> <li>e) Private open space is capable of enabling an extension of the function of the dwelling for relaxation, dining, entertainment, recreation, with direct ground level accessible from the dwelling.</li> <li>f) Private open space forward of the front building line ensures the amenity of the private open space and the dwelling is protected whilst maintaining opportunities for passive surveillance.</li> <li>g) Private open space is to take account of</li> </ul>

Rules	Criteria
June (winter solstice).	outlook, natural features of the site and neighbouring buildings or open space and to provide for maximum year round use.
R91 A minimum of 50% of the private open space is to be retained as planting area.	C91 Unpaved or unsealed areas are provided to facilitate on-site infiltration of stormwater run-off and provision of landscaping.
R92 Where a dwelling is located entirely on an upper floor, private open space is provided in the form of a balcony or courtyard that: a) is located directly off a main daytime living area of the dwelling b) does not face a rear or side boundary within 9 m c) does not face another dwelling within 12m d) has a minimum area of 6 m <sup>2</sup> and dimension of 1.8 m.	C92 The location of private open space is to take account of outlook, natural features of the site and neighbouring buildings or open space and to provide for maximum year round comfort.
<b>5.4 Landscaping</b>	
There is no applicable rule.	C93 A survey and evaluation of existing trees is undertaken and a comprehensive landscape design, indicating the size and type of species proposed, is submitted for consideration.
<b>5.5 Common Areas</b>	
There is no applicable rule.	C94 Common areas, including driveways and access/internal roads, are designed to have clear function, provide equity of access and ensure high levels of residential amenity of all dwellings.

## Element 7: Services

### Intent:

To provide site facilities and service areas and design them to be convenient and visually attractive, blend with the development and street character and require minimal maintenance

Rules	Criteria
<b>7.1 Site Facilities</b>	
There is no applicable rule.	C95 The location and design of site facilities (including garbage bin enclosures, external storage, clothes

Rules	Criteria
	drying areas, car wash bays) to be coordinated and complimentary to the overall building design.
<p>R96</p> <p>An externally accessible, enclosed space for storage is provided for each dwelling without a garage. The storage area is/has a minimum:</p> <ul style="list-style-type: none"> <li>a) area of 1.5 m<sup>2</sup></li> <li>b) 2 m high</li> <li>c) internal dimension of 0.6m.</li> </ul>	<p>C96</p> <p>Dwellings are provided with adequate secure storage areas.</p>
<p>R97</p> <ul style="list-style-type: none"> <li>a) External clothes drying facilities are provided as follows: <ul style="list-style-type: none"> <li>i) dwellings at ground floor level: minimum area of 6 m<sup>2</sup></li> <li>ii) dwelling wholly located at upper floor level: minimum area of 2 m<sup>2</sup>.</li> </ul> </li> <li>b) The clothes drying facilities are screened from public view and are exclusive of private open space requirements.</li> </ul>	<p>C97</p> <p>Dwellings are provided with adequate external clothes drying facilities.</p>

## Part C(2) – Multi Unit Housing - Additional Controls for Deakin and Forrest

This part of the Code applies to development applications for multi unit housing in Deakin, Sections 5-8 and Forrest, Sections 20-22 and 26-27. It provides additional controls to, or controls that are to be applied in lieu of, those in Part C(1) for multi unit housing. The controls have been applied due to the distinctive environmental quality of these historic Sections of South Canberra, particularly in relation to streetscape, block size, on site landscape and built form.

These controls are either in addition to, or in lieu of, those in Part C(1). Where a control is in addition to one contained in Part C(1) it will be identified with the words '**Additional Control**' in the Item title bar. Where a control is in lieu of one contained in Part C(1) it will identify which control it replaces.

Parts A, B and C(1) of this Code also apply.

### Element 2: Building and Site Controls

#### Intent:

- a) To ensure that buildings are compatible, and complement, the built form, siting and scale of surrounding properties and are of an appropriate residential character.
- b) To ensure buildings are designed and sited to provide privacy between neighbours

Rules	Criteria
<b>2.1 Height</b> (Additional Control)	
R98 Buildings do not exceed 11.5 m in height above natural ground level.	This is a mandatory requirement. There is no applicable criterion.
<b>2.2 Front Street Setback</b> (Replaces C(1) R53/C53)	
R99 Buildings are setback a minimum of 10 m from the front street boundary.	C99 Front street setbacks respect the established building lines of surrounding properties.
<b>2.3 Side and Rear Setbacks</b> (Replaces C(1)R54/C54 and C(1)R55/C55)	
There is no applicable rule.	C100 Buildings and other structures are sited and designed to protect a reasonable amount of privacy and solar access to adjacent dwellings and their private open space.

### Element 3: Built Form

**Intent:**

- a) To ensure that buildings are compatible, and complement, the built form, siting and scale of surrounding properties and are of an appropriate residential character.

Rules	Criteria
<b>3.1 Materials and Finish</b> (Additional Control)	
There is no applicable rule.	C101 Buildings are constructed: <ul style="list-style-type: none"><li>a) predominantly of masonry materials</li><li>b) with pitched roofs, except where alterations and/or additions are proposed to existing flat roofed houses.</li></ul>

### Element 5: Amenity

**Intent:**

- a) New development blends into the landscape setting and character of the locality

Rules	Criteria
<b>5.1 Landscaping</b> (Additional Control)	
There is no applicable rule.	C102 An evaluation of exiting trees is undertaken and a comprehensive landscape design, indicating the size and type of species proposed, is submitted for consideration.



## Part C(3) - Multi Unit Housing – Inner North Canberra and Gungahlin District - RZ3 and RZ4 Zones

This Part of the Code applies to development applications for multi unit housing in the RZ3 - Urban and RZ4 – Medium Density Zones in Inner North Canberra and the Gungahlin District. These controls apply instead of those contained in Part C(1) of the Code. Parts A and B of the Code also apply.

### Element 2: Building and Site Controls

#### Intent:

- a) To ensure buildings are compatible with, and complement, the built form, siting and scale of surrounding properties
- b) To ensure buildings are designed and sited to:
  - i) provide privacy between neighbours and between occupants and the public
  - ii) provide adequate light and natural ventilation between dwellings
  - iii) provide opportunities for additional landscaping and to deliver quality open space
  - iv) maintain or enhance the streetscape character in existing areas
  - v) establish appropriate and attractive streetscapes in new residential areas
- c) To ensure the amenity of surrounding properties is maintained, particularly in relation to privacy, overshadowing and solar access

Rules	Criteria
<b>2.1 Height</b>	
R103 Finished floor levels immediately above basement car parking that faces the street is no higher than an average of 600 mm, and a maximum of 750 mm above natural ground level.	C103 Development is designed and sited to ensure that basement car-parking structures do not dominate the development frontage and impact adversely on the streetscape of the locality by screening or limiting the size of structures and openings facing the street.
R104 Differences in building height between existing buildings on adjacent blocks and new developments are not more than one storey when viewed from the street. This requirement applies to building elements within 3.0 m of the front building facade.	C104 Building height at the street frontage maintains a compatible scale with adjacent developments.
<b>2.2 Front Street Setback</b>	
R105 Front setbacks are as specified in Table 5.	C105 Front street setbacks contribute to the existing or proposed streetscape character, assist in the integration of new development into the public streetscape, make efficient use of the site, and

Rules	Criteria
	provide amenity for residents.

**Table 5 : Front Street Setback**

<b>RZ3 - Urban Residential Zone</b>	<b>Lower Floor Level</b>	<b>Upper Floor Level</b>
Adjacent to undeveloped blocks or non-residential development setback $\geq 3$ m	6.0 m	8.5 m
Adjoins development setback $< 3$ m	= To adjacent development	+2.5 m
Adjoins residential development setback 3–4 m	4.0 m	6.5 m
Adjoins residential development setback 4.5–7 m	6.0 m	7.5 m
Adjoins residential development setback 7–9 m	6.0 m	7.5 m
Adjoins residential development setback $\geq 9$ m	6.0 m	7.5 m
Heritage Conservation Area	= Adjoining development	= Adjoining development
Adjoining open space or laneway	4.0 m	4.0 m
Garages and carports	Behind the building line	

Note: The front street setbacks apply to both frontages on corner blocks.

<b>RZ4 – Medium Density Residential Zone</b>	<b>Lower Floor Level</b>	<b>Upper Floor Level</b>
Adjacent to undeveloped blocks or non-residential development setback $\geq 3$ m	3.0 m	5.5 m
Adjoins development setback $< 3$ m	= Adjoining development	+2 m
Adjoins residential development setback 3–4 m	4.0 m	6.0 m
Adjoins residential development setback 4.5–7 m	4.0 m	6.0 m
Adjoins residential development setback 7–9 m	5.0 m	6.0 m
Adjoins residential development setback $\geq 9$ m	6.0 m	6.0 m
Heritage Conservation Area	= Adjoining development	= Adjoining development
Adjoining open space or laneway	4.0 m	4.0 m
Garages and carports	Behind the building line	

Note: The front street setbacks apply to both frontages on corner blocks.

<b>2.3 Side and Rear Setback</b>	
<p>R106</p> <p>A minimum side and rear boundary setback of 1 m is provided for walls at ground level unless the wall is built to the boundary.</p>	<p>This is a mandatory requirement. There is no applicable criterion.</p>
<p>R107</p> <p>Where upper floor levels contain windows with a sill height of less than 1.7 m, or have unscreened decks, balconies or external stairs, the minimum rear and side setbacks are 9 m at the second storey and 12 m at any level at or above three storeys.</p>	<p>C107</p> <p>Setbacks are progressively increased as the height of the wall/building increases so that the built form does not adversely impact on the amenity of neighbouring properties and the streetscape by means such as:</p> <ul style="list-style-type: none"> <li>a) reducing building bulk;</li> <li>b) minimising the length and height of boundary walls;</li> <li>c) providing sufficient spatial separation between upper floor levels of adjoining development</li> <li>d) protecting a reasonable amount of privacy and solar access to adjacent dwelling and their associated private open space.</li> </ul>
<b>2.4 Building Envelope</b>	
<p>R108</p> <ul style="list-style-type: none"> <li>a) The following building elements may extend beyond the building envelope (provided the distance to the boundary is not less than 1 m): <ul style="list-style-type: none"> <li>i) Fascias, gutters, downpipes</li> <li>ii) Eaves up to 0.75 m</li> <li>iii) Masonry chimneys, flues, pipes</li> <li>iv) Domestic fuel tanks</li> <li>v) Cooling or heating appliances or other services</li> </ul> </li> <li>b) Development that may extend beyond the building envelope, without restriction, includes the following: <ul style="list-style-type: none"> <li>i) Pergolas, screens or sunblinds</li> <li>ii) Light fittings, electricity connections</li> <li>iii) Unroofed terraces, landings, steps or ramps not more than 1m in height.</li> </ul> </li> </ul>	<p>This is a mandatory requirement. There is no applicable criterion.</p>

There is no applicable rule.	<p>C109</p> <p>Building to the boundary may be considered where the walls are limited in length and height and where it is demonstrated that building to the boundary is necessary to maximise privacy for neighbouring dwellings and their associated private open space.</p>
------------------------------	--

### Element 3: Built Form

#### Intent:

- a) To achieve a coherent site layout that provides a pleasant, attractive, manageable, resource efficient and sustainable living environment
- b) To ensure buildings are compatible with, and complement, the positive elements of the built form of surrounding development; enhance existing or planned future patterns of development; and provide attractive streetscapes
- c) To ensure there is diversity in building type and size
- d) To allow flexibility in design and use of materials and colours while encouraging high quality architectural standards that contribute to harmonious and attractive streetscapes
- e) Development is designed to facilitate pedestrian access from the street frontage, car parking areas and public open space and provide an individual identity in respect of each dwelling
- f) To provide adequate separation between dwellings and windows for privacy
- g) To ensure that fencing (including courtyard walls) provides privacy, security and noise attenuation without having a detrimental impact upon the streetscape and adjoining buildings
- h) To ensure buildings and landscaping provides for resident and visitor safety and mobility

Note: Under the *Building Act 2004* most buildings need to meet the requirements of the Building Code of Australia. For certain classes of buildings, this will include prescribed energy requirements.

Rules	Criteria
<b>3.1 Building Design</b>	
There is no applicable rule.	<p>C110</p> <p>A site analysis plan is submitted demonstrating that site layout and building design:</p> <ol style="list-style-type: none"> <li>a) Compliments: <ol style="list-style-type: none"> <li>i) Existing or future planned built form, in terms of scale, character and massing, in the locality</li> <li>ii) landscape character, achieved through attention to silhouette, pattern, texture and colour</li> <li>iii) residential identity</li> <li>iv) streetscape character and functions</li> <li>v) existing important site features</li> </ol> </li> </ol>

Rules	Criteria
	<ul style="list-style-type: none"> <li>vi) heritage places, and</li> <li>b) integrates with the surrounding environment through:               <ul style="list-style-type: none"> <li>i) adequate pedestrian, cycle and vehicle links to street and open space networks</li> <li>ii) dwellings face the street and public open spaces</li> <li>iii) clear definition of the public and private realm.</li> </ul> </li> </ul>
<p>R111</p> <p>Maximum length of unarticulated walls in buildings containing more than two dwellings is 15 m. Wall articulation is provided by:</p> <ul style="list-style-type: none"> <li>a) changes in wall planes of a minimum 1.0 m in depth and 4.0 m in length</li> <li>b) inclusion of balconies, fin walls, etc OR</li> <li>c) horizontally stepping facades by at least 1.0 m</li> </ul>	<p>C111</p> <p>Building design, articulation, detailing and finish provide an appropriate scale, add visual interest, and enable visual differentiation between dwellings when viewed from public streets.</p>
<p>R112</p> <p>Buildings address the street and communal areas by providing front door, porch, verandah or living room or kitchen window facing the street or communal areas.</p>	<p>C112</p> <p>Buildings adjacent to the street or communal areas address these areas by providing visual interest in building design and passive surveillance of these areas.</p>
<p>R113</p> <p>Dwellings with two bedrooms:</p> <ul style="list-style-type: none"> <li>a) provide a minimum of two bedrooms that can accommodate a double bed</li> <li>b) separate bedrooms from each other with bathrooms or other rooms, or by locating them next to walls with minimum noise transmission</li> <li>c) provide more than one living space or a living-dining space that can be functionally divided</li> <li>d) arrange rooms off a central circulation space connected to the entry.</li> </ul>	<p>C113</p> <p>Dwellings designed for more than one person are adaptable to suit a range of household types, by maximising potential for personal space and privacy.</p>
<p>There is no applicable rule.</p>	<p>C114</p> <p>Entries to dwellings:</p> <ul style="list-style-type: none"> <li>a) are clearly visible from streets or internal driveways so that visitors can easily identify</li> </ul>

Rules	Criteria
	<p>a particular dwelling eg. articulated with a verandah or porch;</p> <p>b) give the resident a sense of personal address, shelter and transitional space around the entry; and</p> <p>c) help provide a level of security for the occupants.</p>
<b>3.2 Materials and Finish</b>	
There is no applicable rule.	<p>C115</p> <p>Development uses appropriate building materials and colours to add visual interest and reduce visual bulk.</p>
<p>R116</p> <p>Courtyard walls are constructed with the same material and finish as used in the main building.</p>	<p>C116</p> <p>Materials used in the construction of courtyard walls are compatible and complements the design of the main building/s, and where relevant, the streetscape character of the locality.</p>
<p>R117</p> <p>Walls to exposed basement parking structures:</p> <p>a) are enclosed in masonry construction, as a continuation of the external wall of the main building</p> <p>b) have ventilation openings treated as part of the facade with grilles and screens.</p>	<p>C117</p> <p>Garages and parking structures are sited and designed so as not to dominate the dwelling frontage by ensuring that roof form, materials and detailing complement that of the associated dwelling.</p>
There is no applicable rule.	<p>C118</p> <p>Building materials visible from public areas and adjoining properties are compatible and complementary with the character of neighbouring buildings.</p>
<p>R119</p> <p>Structures and plant and equipment situated on the roof are not visible from the street or unleased Territory Land unless exempt under <i>Planning &amp; Development Act 2007</i>. This includes water tanks, solar energy devices, evaporative cooling or air conditioning devices, a radio mast or aerial, or a satellite dish.</p>	<p>C119</p> <p>Any structures and plant and equipment situated on or visible above the roofline are not excessively obtrusive or significantly impact on the amenity of the streetscape or neighbours.</p>

Rules	Criteria
<b>3.3 Interface</b>	
<p>R120</p> <p>Fences are permitted in accordance with the <i>Common Boundaries Act 1981</i>.</p>	<p>This is a mandatory requirement. There is no applicable criterion.</p>
<p>There is no applicable rule.</p>	<p>C121</p> <p>Fences may be permitted where the proposal meets the requirements contained in the Residential Boundary Fences General Code.</p>
<p>R122</p> <p>Free standing walls or fencing are not permitted forward of the building line unless previously approved in an estate development plan or consistent with a relevant precinct code.</p>	<p>This is a mandatory requirement. There is no applicable criterion.</p>
<p>R123</p> <p>Maximum height for courtyard walls and fences forward of the building line are:</p> <ul style="list-style-type: none"> <li>a) 1 m, where of solid construction</li> <li>b) 1.5 m, where incorporating openings with vertical or horizontal grilles, which result in the wall or fence being not less than 50% transparent.</li> </ul>	<p>C123</p> <p>Courtyard walls and fences forward of the building line may be considered where they enable use of private open space abutting the street or provide an acoustic barrier to traffic noise whilst maintaining opportunities for casual surveillance of public places</p>
<p>There is no applicable rule.</p>	<p>C124</p> <p>Courtyard walls and fences forward of the building line:</p> <ul style="list-style-type: none"> <li>a) incorporate architectural detail to assist in highlighting entrances and creating a sense of communal identity within the streetscape</li> <li>b) are designed and detailed to provide visual interest to the streetscape and provide for landscaping to reduce their scale and soften the visual impact of the wall surfaces</li> <li>c) use materials that are compatible with and complement the design of the main building/s and, where relevant, the streetscape character of the locality.</li> </ul>
<p>R125</p> <p>Courtyard walls and fences do not replace existing mature hedges.</p>	<p>C125</p> <p>Replacement of mature hedges with courtyard walls and fences may be considered where the hedge is a listed weed species or is similarly inappropriate, or not an important element of the streetscape.</p>

Rules	Criteria
<p>R126</p> <p>A minimum separation of 9 m is provided between the windows of habitable rooms of facing dwellings. This distance is 12 m for windows above the first floor level.</p>	<p>C126</p> <p>Direct overlooking of main internal living areas and private open spaces of other dwellings are limited by building layout, location and design of windows and balconies, screening devices and landscape, or remoteness.</p>
<p>R127</p> <p>Where windows of habitable rooms of facing dwellings are within 9 m, they:</p> <ul style="list-style-type: none"> <li>a) are offset from the edge of one window to the edge of the other by a distance of 2 m OR</li> <li>b) have sill heights of 1.7 m above the finished floor level OR</li> <li>c) have fixed obscure glazing in any part of the window below 1.7 m above the finished floor level.</li> </ul>	<p>C127</p> <p>Direct views between the windows of habitable rooms of adjacent dwellings are screened or obscured by use of architectural devices or landscape screening where it is demonstrated that building design and siting can not achieve the desired level of visual privacy and where screening devices are integrated into the building design.</p>
<p>R128</p> <p>Outlook from windows and balconies of an upper floor level dwelling are designed, screened or obscured to prevent overlooking of more than 50% of the private open space of a lower floor level dwelling directly below and within the same development.</p> <p>Where screening devices are to be utilised to limit overlooking they are to be solid translucent screens or perforated panels or trellises which have a maximum of 25% opening and which are:</p> <ul style="list-style-type: none"> <li>a) permanent or fixed</li> <li>b) the same colour as the associated building.</li> </ul>	<p>C128</p> <p>Direct overlooking of private open spaces of other dwellings is limited by building layout, location and design of windows and balconies, screening devices and landscape, or remoteness.</p>
<b>3.4 Accessibility (Mobility)</b>	
<p>R129</p> <p>10% of the dwellings of any multi-unit housing development consisting of 10 or more dwellings is designed to meet the relevant Australian Standard or building code for adaptable housing.</p>	<p>This is a mandatory requirement. There is no applicable criterion.</p>



Rules	Criteria
<p>R130</p> <p>A minimum of 20% of ground floor level dwellings comply with the access requirements of <i>AS1428.1 Design for Access and Mobility Part 1: General Requirements for Access - New Building Work</i>.</p>	<p>C130</p> <p>The development meets the requirements of the Access and Mobility General Code.</p>
<b>3.5 Crime Prevention</b>	
<p>There is no applicable rule.</p>	<p>C131</p> <p>Clear lines of sight and well-lit areas and routes are provided throughout development, particularly for:</p> <ul style="list-style-type: none"> <li>a) driveways and car parks</li> <li>b) routes from car-parking areas</li> <li>c) public areas</li> <li>d) dwelling entries</li> <li>e) lift and stair lobbies to apartments.</li> </ul>
<p>R132</p> <p>External lighting is provided to building frontages, to all pathways, roads, laneways and car-parking areas in accordance with Australian Standard <i>AS1158.1.3 Pedestrian Lighting</i>.</p>	<p>C132</p> <p>External lighting is provided in accordance with the ACT Crime Prevention and Urban Design Resource Manual.</p>
<p>R133</p> <ul style="list-style-type: none"> <li>a) Building design allows visitors who approach the front door to be seen without the need to open the door.</li> </ul> <p>AND</p> <ul style="list-style-type: none"> <li>b) Entrance doors, stairwells and balconies are to be configured so that access and entrance to each dwelling is simple, safe, secure, direct and easily used by both residents and visitors</li> </ul>	<p>C133</p> <p>Building entries provide a sense of security for both residents and visitors.</p>

#### Element 4: Parking and Site Access

##### Intent:

- a) To encourage design of access and parking as part of the overall landscape design of the development
- b) To provide convenient, accessible and safe access and parking to meet the needs of the residents and visitors and service vehicles
- c) Car parking and garages do not dominate the frontage of development

Rules	Criteria
<b>4.1 Vehicle Access</b>	
<p>R134</p> <p>Individual parking spaces are accessed from a common driveway in developments of more than two dwellings.</p>	<p>C134</p> <p>Where development is on a corner block access may be provided from both street frontages where:</p> <ul style="list-style-type: none"> <li>a) the amenity of neighbouring residential areas and streetscapes is not unacceptably affected by the provision of parking and access</li> <li>b) no traffic hazards are created by the provision of access and parking facilities for a development</li> <li>c) the safety of all users, especially pedestrians and cyclists, is considered</li> <li>d) the creation of community surveillance of car parking areas by people using neighbouring areas</li> <li>e) parking generated by a development does not unacceptably affect the safe and efficient functioning of traffic and access to neighbouring areas</li> <li>f) adequate supply of parking for the level of demand generated by the development</li> <li>g) safe and efficient access for all users, with the needs of residents and visitors being catered for by the on-site provision of adequate parking.</li> </ul>
<p>R135</p> <p>In relation to driveways, access/internal roads and car parks:</p> <ul style="list-style-type: none"> <li>a) Walls of dwelling incorporating an opening to a habitable room are to be setback are to be setback a minimum of 1.5 m. This setback may be reduced to 1 m where there is an intervening fencing 1.5 m high or greater, or where the window sill is a minimum of 1.5 m above the driveway, access/internal road and car park.</li> <li>b) the minimum width of driveways and access roads is 3 m</li> <li>c) where there are changes in direction or intersections, the internal radius of the driveways and access road are at least 4 m</li> </ul>	<p>C135</p> <p>Driveways allow safe and efficient vehicle movement and good connections to the existing street network as well as providing a high quality pedestrian priority environment.</p>

Rules	Criteria
<p>d) where more than 10 car spaces are served and the driveways and access road connects to a public road, the entrance is at least 5 m wide for a distance of 7 m from the street front boundary to allow vehicles to pass each other</p> <p>e) a turning space is provided so cars can enter and leave in a forward direction where a driveway:</p> <p>i) serves 5 or more care spaces, or</p> <p>ii) serves 5 or more care spaces, or</p> <p>iii) serves 3 or more care spaces, or</p> <p>iv) connects to a major road.</p>	
<p>R136</p> <p>In accordance with section 148 of the <i>Planning and Development Act 2007</i>, applications are accompanied by a statement of compliance from the Department of Territory and Municipal Services stating that the verge crossovers are designed and sited to comply with the requirements of <i>ACT Urban Services Design Standards for Kerb Crossings and Driveways</i>.</p>	<p>C136</p> <p>If a statement of compliance is not provided, the application will be referred to the Department of Territory and Municipal Services in accordance with the requirements of the <i>Planning and Development Act 2007</i>.</p>
<p>There is no applicable rule.</p>	<p>C137</p> <p>Service areas and set down arrangements provide for the efficient operations of the development whilst protecting resident amenity and avoiding impacts on adjoining streets.</p>
<p><b>4.2 Parking</b></p>	
<p>R138</p> <p>Car-parking areas are located behind the building or incorporated into the dwelling.</p>	<p>C138</p> <p>Car parking areas are located to minimise visual impact from the street and so as not to dominate the development frontage.</p>
<p>R139</p> <p>The maximum width of garages and carports is 6 m, or 50% of the frontage of the dwelling, whichever is less, except for entries to basement car parking which are a maximum width of 8 m.</p>	<p>C139</p> <p>Garages and car parking structures are designed and sited so they do not dominate the dwelling or development frontage.</p>
<p>There is no applicable rule.</p>	<p>C140</p> <p>Car-parking areas and driveways are designed, surfaced and sloped to encourage and facilitate stormwater infiltration on site.</p>

Rules	Criteria
There is no applicable rule.	<p>C141</p> <p>Car parking areas are suitably landscaped and surfaced to enhance amenity while providing for security needs of residents and visitors, and to avoid large expanses of hardstand surfaces.</p>
<b>4.3 Circulation</b>	
<p>R142</p> <p>Shared entries (e.g. interior stairways, corridors or balcony walkways) serve a maximum of nine dwellings.</p>	<p>C142</p> <p>a) Building design provides residents with a sense of personal address, shelter and transitional space at the entry to a dwelling.</p> <p>b) Dwelling entry is easily identifiable and accessible for visitors.</p>
There is no applicable rule.	<p>C143</p> <p>Shared entries, doors and passageways are direct and wide enough to allow for furniture movement and wheelchair access.</p>

## Element 5: Amenity

### Intent:

To ensure:

- a) Dwellings provide their occupants with adequate levels of comfort, acoustic privacy, security and amenity
- b) Development is sited and designed to optimise solar access to private open space and living areas of dwellings
- c) Dwellings are provided with private and useable private open space that is integrated with, and directly accessible from, the living areas of the dwelling
- d) Any communal open space provided for dwellings is clearly defined and useable and helps create a pleasant, safe and attractive living environment
- e) Buildings are integrated with landscape elements
- f) New development blends into the landscape setting of an established streetscape and neighbourhood
- g) The appearance and amenity of new development is enhanced

Rules	Criteria
<b>5.1 Solar Access</b>	
<p>R144</p> <p>Buildings opposite a window to a habitable room do not exceed the height created by a plane projected at 60 degree above horizontal from 750 mm above the floor level at the window for a lateral distance defined by a 60 degree arc from the centre of the window.</p>	<p>C144</p> <p>Building envelopes and dwelling layouts optimise day lighting of dwellings.</p>
<p>R145</p> <p>North-facing windows to main living areas are setback from any building on the same block so that the building is sited within a plane projected at 30 degrees above horizontal from 750 mm above floor level at the window for a lateral distance of up to 30 degrees east and west of north, or set back at least 3 m from any boundary to the north.</p>	<p>C145</p> <p>Building envelopes and dwelling layouts optimise energy efficiency.</p>
<p>R146</p> <p>Development is sited to allow a minimum of 3 hours of direct sunlight onto the floor or wall of the internal primary living space and the private open space of any dwelling within the development and any dwelling/s adjacent the subject site, between the hours of 9.00am and 3.00pm on 21 June (winter solstice).</p>	<p>C146</p> <p>Optimum winter sunlight to north-facing windows of living areas and private open spaces is achieved.</p>
<b>5.2 Neighbourhood Plans</b>	
<p>There is no applicable rule.</p>	<p>C147</p> <p>Where a Neighbourhood Plan exists, development demonstrates response to the key strategies and actions of the relevant Neighbourhood Plan.</p>

<b>5.3 Private Open Space</b>	
<p>R148</p> <p>The area of private open space for ground level dwellings are:</p> <ul style="list-style-type: none"> <li>a) a minimum of 30 m<sup>2</sup> in RZ3 zones</li> <li>b) a minimum of 24 m<sup>2</sup> in RZ4 zones</li> <li>c) a minimum dimension of 4 m x 4 m</li> <li>d) screened from public view</li> <li>e) directly accessible from a main daytime living area of the dwelling</li> <li>f) able to achieve a minimum 3 hours of direct sunlight onto 50% of the ground between the hours of 9.00 am and 3.00 pm on 21 June (winter solstice).</li> </ul>	<p>C148</p> <p>The area of private open space is:</p> <ul style="list-style-type: none"> <li>a) large enough to suit the projected requirements of the dwelling's occupants and to accommodate outdoor recreation needs and service functions such as clothes drying</li> <li>b) capable of serving as an extension of the function of the dwelling and of being accessed from a main living area of the dwelling</li> <li>c) oriented to enable solar access and helping to achieve comfortable year round use by the dwelling's occupants.</li> </ul>
<p>There is no applicable rule.</p>	<p>C149</p> <p>The area of private open space is capable of supporting small trees and shrubs in natural ground.</p>
<p>R150</p> <p>The area of private open space for upper floor level dwellings is:</p> <ul style="list-style-type: none"> <li>a) be a minimum area of 6 m<sup>2</sup> with a minimum dimension of 1.8 m</li> <li>b) be directly accessible from a main daytime living area of the dwelling</li> <li>c) incorporate a minimum area of 2 m<sup>2</sup> for service functions, such as air conditioners and clothes drying, which is additional to this minimum area.</li> </ul>	<p>C150</p> <p>The area of private open space for upper floor level dwellings is:</p> <ul style="list-style-type: none"> <li>a) large enough to suit the projected requirements of the dwelling's occupants and to accommodate outdoor recreation needs and service functions such as clothes drying</li> <li>b) capable of serving as an extension of the function of the dwelling and of being accessed from a main living area of the dwelling</li> <li>c) oriented to enable solar access and helping to achieve comfortable year round use by the dwelling's occupants.</li> </ul>
<p>There is no applicable rule.</p>	<p>C151</p> <p>The location of private open space takes advantage of outlook and natural features of the site and helps to achieve comfortable year round use.</p>

<b>5.4 Communal Open Space</b>	
<p>R152</p> <p>For apartment developments, 20% of the total site area is to be provided as communal open space that is centrally located with at least 50% located on natural ground level.</p> <p>Note: The calculation of the communal open space does not include front setbacks or narrow strips of residual land not visually or physically incorporated into the area, or areas not readily accessible by residents.</p>	<p>C152</p> <p>Communal open space:</p> <ul style="list-style-type: none"> <li>a) contributes to the legibility and character of the development</li> <li>b) provides for a range of uses and activities</li> <li>c) contributes, wherever possible, to stormwater management</li> <li>d) provides landscaping to enhance and define the area, including provision for large scale trees and deep rooted planting.</li> </ul>
<p>R153</p> <p>Total open space for town house developments (including private open space) is not less than 50 m<sup>2</sup> per townhouse and is located at ground level.</p>	<p>C153</p> <p>Both private and communal open space is provided for town house developments. The communal open space:</p> <ul style="list-style-type: none"> <li>a) contributes to the legibility and character of the development</li> <li>b) provides for a range of uses and activities</li> <li>c) contributes, wherever possible, to stormwater management</li> <li>d) provides landscaping to enhance the area.</li> </ul>
<b>5.5 Landscaping</b>	
<p>There is no applicable rule.</p>	<p>C154</p> <ul style="list-style-type: none"> <li>a) An evaluation of existing trees is undertaken and a comprehensive landscape design, indicating the size and type of species proposed, is submitted for consideration.</li> </ul>

<p>There is no applicable rule.</p>	<p>C155</p> <p>Landscape design establishes a character that blends development into the existing streetscape and:</p> <ul style="list-style-type: none"> <li>a) is sensitive to site and landscape attributes</li> <li>b) maximises on-site infiltration of stormwater runoff by minimising areas of paved or sealed landscaping</li> <li>c) respects and protects streetscapes and landscapes of documented heritage significance</li> <li>d) is of an appropriate scale relative to the road reserve width and building bulk;</li> <li>e) retains major existing trees wherever practicable</li> <li>f) uses vegetation types and landscaping styles and scale that complement the streetscape and the landscape of adjoining development</li> <li>g) integrates with parks, reserves and public transport corridors</li> <li>h) does not adversely affect the structure of the proposed buildings</li> <li>i) ensures good visibility along paths and driveways and avoids dense landscaping near thoroughfares</li> <li>j) contributes to energy efficiency and amenity by providing substantial shade in summer, especially to west-facing windows and open car-parking areas, and admitting winter sunlight to outdoor and indoor living areas, especially to the north</li> <li>k) improves privacy and minimises overlooking between dwellings</li> <li>l) satisfies maintenance and utility requirements and minimises the visual impact of aboveground utilities</li> <li>m) minimises risk of damage to overhead and underground power lines and other services</li> <li>n) provides safe and secure pathways and access to all facilities on site</li> <li>o) provides adequate sight lines for vehicles and pedestrians, especially near street corners and intersections</li> <li>p) does not obscure or obstruct dwelling entries, paths and driveways to reduce the actual or perceived personal safety and security.</li> </ul>
-------------------------------------	---



<b>5.6 Acoustic Privacy</b>	
<p>R156</p> <p>Buildings are constructed in accordance with <i>Australian Standard 3671: Acoustics - Road Traffic Noise Intrusion, Building Siting and Construction</i>.</p>	<p>C156</p> <p>The design and siting of buildings minimises noise penetration into dwellings exposed to off-site noise. Separation distances or acoustic barriers are provided to achieve acoustic privacy between dwellings.</p>
<p>There is no applicable rule.</p>	<p>C157</p> <p>The siting and building design reduces the impact of noise and provides acoustic privacy to habitable rooms.</p>
<p>R158</p> <p>Bathrooms, hallways, stairways, storage rooms and kitchens are located between noise sources and habitable rooms where other methods of noise attenuation are not provided.</p>	<p>C158</p> <p>The room layout of the dwelling reduces the impact of noise and provides acoustic privacy to habitable rooms.</p>
<p>R159</p> <p>a) Bedroom windows are located a minimum of 3 m from internal roads and driveways and parking areas of other dwellings</p> <p>b) Appliances (eg. heat pumps) are not located adjacent to habitable rooms of any dwellings on the site or neighbouring blocks</p> <p>c) Garages are not located adjacent to bedrooms of any dwellings.</p>	<p>C159</p> <p>The building design and siting provides acoustic separation between active recreation areas, parking areas, driveways and service equipment areas and other noise sources (eg, busy roads) and bedrooms and minimises high levels of external noise entering dwellings.</p>
<p>R160</p> <p>Openings to a habitable room are as follows:</p> <p>a) living areas: set back a minimum of 1.5 m from internal roads, driveways, noise generating service facilities and car parking areas. The minimum setback of openings to living areas may be reduced to 1 m where:</p> <p>i) there is an intervening fence of 1.5 m or higher OR</p> <p>ii) the window sill is a minimum of 1.5 m above the level of the internal road, driveway or car park.</p> <p>b) bedrooms: set back a minimum of 3 m from internal roads, driveways and car parking areas.</p>	<p>C160</p> <p>Vehicle circulation routes, communal open spaces and noise generating service facilities and parking areas are acoustically separated from openings to habitable rooms through building design and siting.</p>

<b>5.7 Natural Ventilation</b>	
R161 Buildings have a maximum depth of 12 m.	C161 Dwellings are designed to provide acceptable thermal conditions with regard to air movement.

## Element 7: Services

### Intent:

- a) To ensure adequate provision of services and facilities to cater for demand from residents
- b) To protect easements and service reservations

<b>Rules</b>	<b>Criteria</b>
<b>7.1 Utilities</b>	
R162 Electrical and telecommunication reticulation is undergrounded in developments involving more than 2 blocks.	C162 The design of the development satisfies maintenance and utility requirements and minimises the visual impact of above ground utilities. Any electrical or telecommunications equipment such as substations or switching station, which are required as part of a development, are to be located within lease boundaries and where possible behind the building line and screened by landscaping or incorporated within the building.
<b>7.2 Storage Area</b>	
R163 An enclosed space for storage is provided as follows: a) studio and one bedroom dwellings: 4 m <sup>2</sup> with a minimum 2 m height b) two and three+ bedroom dwellings: 5 m <sup>2</sup> with a minimum 2 m height.	C163 An enclosed space of 8m <sup>2</sup> per dwelling is provided exclusively for external secure storage. This space may form part of a carport or garage.
<b>7.3 Service Areas</b>	
R164 Individual mailboxes are located at each ground floor level dwelling entry, or in a mail box structure located close to the main pedestrian entrance to the site, in compliance with Australia Post mail delivery requirements.	C164 Mailboxes are located for convenient access by residents and deliverers with passive surveillance from the street or from active uses.
There is no applicable rule.	C165 External clothes drying facilities are provided in the form of: a) open air, communal clothes drying facilities that are easily accessible for all residents

Rules	Criteria
	<p>and visually screened from public areas and/or</p> <p>b) open air, private clothes drying facilities may be located on private balconies provided they are additional to private open space requirements (by 2m<sup>2</sup>) and screened from view outside the development.</p>

## Part C(4) - Multi Unit Housing – Kingston/Griffith – RZ5 Zone

This Part of the Code applies to development applications for multi unit housing in excess of 2 storeys in the RZ5 High Density Zone as it applies to Kingston and Griffith. These controls apply instead of those contained in Part C(1) of the Code. Parts A and B of the Code also apply.

### Element 2: Building and Site Controls

Intent:

- a) To obtain a scale of development that establishes a unified and coherent urban streetscape
- b) To provide densities appropriate to an area close to the Central National Area
- c) To protect isolated blocks
- d) To ensure occupants receive adequate sunlight and privacy, and reduce the dominance of built form on streetscapes and internal open spaces.

Rules	Criteria
<b>2.1 Block Amalgamations – Kingston Sections 27 and 28</b>	
R166 On Kingston Sections 27 and 28 adjacent to Wentworth Avenue, blocks are to be amalgamated so as to have a minimum area of 0.3ha, with a continuous length of at least 60m to any street frontage.	C166 Development on blocks smaller than 0.3ha is to demonstrate that it achieves the highest standards of architectural design and does not impact on the amenity of neighbouring properties or occupants of the proposed development.
There is no applicable rule.	C167 Block amalgamations do not preclude other blocks from being redeveloped.
<b>2.2 Redevelopment on Other Sections</b>	
There is no applicable rule.	C168 Where the development potential of blocks may have been reduced due to previous patterns of development, two block amalgamation or redevelopment of single blocks may be considered where the height and design of the development will not significantly compromise the amenity of residents of the proposed building and residents of adjoining and adjacent dwellings.

<b>2.3 Building Height</b>	
<p>R169</p> <p>a) 3 storeys in height.</p> <p>b) 11 m in height from natural ground level to the highest point of the parapet eaves or fascia.</p> <p>c) 15 m in height from natural ground level to the highest point of the roof.</p>	<p>C169</p> <p>The height of the development is predominantly 3 storeys with a maximum height of 4 storeys. Four storey elements are not the dominant feature of a street frontage and respect the established built form.</p>
<b>2.4 Building Height – Kingston Sections 27 and 28</b>	
<p>R170</p> <p>Where development is adjacent to blocks that are unable to be amalgamated due to previous patterns of development, then the maximum building height at the interface is 2 storeys.</p>	<p>C170</p> <p>The development demonstrates that the highest standards of architectural design can be achieved and does not significantly compromise the amenity of residents of the proposed building and residents of adjoining and adjacent dwellings</p>
<b>2.5 Side and Rear Setback</b>	
<p>R171</p> <p>Side and rear setbacks are a minimum of:</p> <p>a) 6m where the design incorporates blank walls, windows with sill heights greater than 1.7 m from the floor or windows with fixed panes of obscure glass</p> <p>b) 12m where design incorporates other walls, outer faces of unscreened decks, balconies and external stairs.</p>	<p>C171</p> <p>Buildings are sited to minimise overlooking, and ensure protection of visual and acoustic privacy, of adjacent dwellings.</p>
<p>There is no applicable rule.</p>	<p>C172</p> <p>Setbacks are progressively increased as the height of the wall/building increases so that the built form does not adversely impact on the amenity of neighbouring properties.</p>
<b>2.6 Interface</b>	
<p>R173</p> <p>a) The minimum distance between habitable rooms of dwellings where there is a screen wall is:</p> <p>i) Lower floor level – 6m</p> <p>ii) Upper floor levels – 12m</p> <p>b) The minimum distance between habitable rooms of dwellings where there is no screen wall is 12 m.</p>	<p>This is a mandatory requirement. There is no applicable criterion.</p>

<p>c) The minimum distance between non-habitable rooms is:</p> <p>i) Lower floor level - 3m</p> <p>ii) Upper floor levels - 6m</p> <p>d) The minimum distance between non-habitable rooms with blank walls or windows with sill heights greater than 1.7 m:</p> <p>i) Lower floor level – 1.5m</p> <p>ii) Upper floor levels – 3m</p>	
<p>R174</p> <p>Where buildings face an internal courtyard the minimum interface distances is:</p> <p>i) Partly enclosed courtyard – 15 m</p> <p>ii) Fully enclosed courtyard – 20 m</p>	<p>C174</p> <p>Interface distances between internal buildings provide visual and acoustic privacy for residents.</p>

### Element 3: Built Form

#### Intent:

- a) To secure design excellence in all aspects of residential redevelopment
- b) To ensure that external design and siting of buildings, including external materials, colours and finishes, harmonise with attractive elements in surrounding development in the area.
- c) To ensure that building design, detailing and finishes provide an appropriate scale to the street, provide visual interest and relate ground floor levels on street frontages to adjacent foot paths and verges.
- d) To retain the existing landscape elements of the street scene and the overall treescape of the area and ensure service infrastructure does not cause deterioration in the streetscape.

Rules	Criteria
<b>3.1 Building Design</b>	
<p>R175</p> <p>The maximum length of unarticulated walls to street frontages is 15 m. Unarticulated walls are to be punctuated by features such as bay windows, verandas and balconies.</p>	<p>This is a mandatory requirement. There is no applicable criterion.</p>
<p>There is no applicable rule.</p>	<p>C176</p> <p>Exposed end walls incorporate architectural elements, features or modulation to provide visual interest.</p>

Rules	Criteria
<p>R177</p> <p>With the exception of down pipes, there is no externally exposed plumbing attached to building walls.</p>	<p>This is a mandatory requirement. There is no applicable criterion.</p>
<b>3.2 Building Design – Ground Floor Commercial Uses</b>	
<p>R178</p> <p>Where front building setbacks are less than 6m, the minimum ground floor finished floor level to finished ceiling level height is 3.6m.</p>	<p>C178</p> <p>Ground floor ceiling height beyond minimum standards allows for more uses.</p>
<b>3.3 Materials and Finish</b>	
<p>There is no applicable rule.</p>	<p>C179</p> <p>Development provides:</p> <ul style="list-style-type: none"> <li>a) Rich, imaginative and subtle design elements,</li> <li>b) Articulation in the horizontal and vertical planes,</li> <li>c) Detailing that adds interest and vitality to the streetscape.</li> </ul>
<p>There is no applicable rule.</p>	<p>C180</p> <p>External materials and colours are respectful of the surrounding built form.</p>
<p>There is no applicable rule.</p>	<p>C181</p> <p>Roof colours are consistent throughout the development and, if metal roofing is used, are pre-coloured and non-reflective.</p>
<p>There is no applicable rule.</p>	<p>C182</p> <p>Garages and carports use materials, colours, and design details, including roof form and building height, compatible with the primary building.</p>
<p>There is no applicable rule.</p>	<p>C183</p> <p>Basement and undercroft car parks are designed and landscaped to avoid extensive exposure of ventilation openings to streets and other communal areas.</p>
<b>3.4 Interface</b>	
<p>There is no applicable rule.</p>	<p>C184</p> <ul style="list-style-type: none"> <li>a) Substantial landscaped areas are provided behind the front building zone to ensure that the overall treescape of the area is maintained.</li> </ul>

Rules	Criteria
	<ul style="list-style-type: none"> <li>b) Landscaping is predominantly at natural ground level to maximise tree height and intensity.</li> <li>c) In small developments where there is rear parking or garaging areas they are designed and constructed with extensive tree planting.</li> <li>d) Courtyards are landscaped to a high standard.</li> </ul>
There is no applicable rule.	<p>C185</p> <p>Lower floors levels constructed above finished ground level:</p> <ul style="list-style-type: none"> <li>a) Are designed or landscaped to minimise visual disparities, and</li> <li>b) Do not exceed an average of one metre above natural ground level.</li> </ul>
<b>3.5 Courtyard Walls</b>	
<p>R186</p> <p>Courtyard walls do not exceed 1.8m in height.</p>	This is a mandatory requirement. There is no applicable criterion.
There is no applicable rule.	<p>C187</p> <p>Courtyard walls:</p> <ul style="list-style-type: none"> <li>a) Consist of materials that harmonise with the materials, colours and finishes used in the main body of the development</li> <li>b) Incorporate adequate space for appropriate landscaping to reduce the scale and visual impact of large areas of walled surfaces,</li> <li>c) Incorporate gates where practicable and emphasise entries.</li> <li>d) Do not replace existing mature hedges.</li> </ul>
<b>3.6 Accommodation Diversity</b>	
There is no applicable rule.	<p>C188</p> <p>A mix of unit types and sizes are provided within the development to cater to a range of resident needs.</p>



## Element 4: Parking and Site Access

### Intent:

- a) To provide sufficient, convenient and safe car parking for residents, visitors and service vehicles
- b) To minimise the number of driveway crossings
- c) To minimise the visual impact of parking and service areas from the street and within the new development

Rules	Criteria
<b>4.1 Vehicle Access</b>	
R189 Road pavements are 5.5 m wide with a minimum 18 m diameter turning circle where required.	This is a mandatory requirement. There is no applicable criterion.
There is no applicable rule.	C190 Car parks, access ways, driveways and internal roads allow comfortable, safe and efficient vehicle movement and good connections to the existing street network.
<b>4.2 Parking</b>	
There is no applicable rule.	C191 Parking complies with the requirements of the Parking and Vehicular Access General Code.
R192 Minimum dimensions of on-site car parking spaces are 5.5 m x 2.5 m.	This is a mandatory requirement. There is no applicable criterion.
R193 Car parking spaces are not located between the front boundary and the building line.	C193 Parking spaces are configured to minimise their visual impact from the street and maintain streetscape amenity.
There is no applicable rule.	C194 Parking facilities are located close to and convenient to dwellings, and are adequately lit at night, sheltered and clearly defined.

## Element 5: Amenity

### Intent:

- a) To provide for an attractive living environment with maximised visual and acoustic privacy
- b) To integrate the landscape treatment with the building design
- c) To ensure communal open space provided for dwellings is clearly defined and useable and helps create a pleasant, safe and attractive living environment

Rules	Criteria
<b>5.1 Communal Open Space</b>	
<p>R195</p> <p>The minimum area of useable open space is 50% of the gross floor area of the development.</p> <p>A maximum of 40% of this space is provided as private open space, such as private balconies, courtyards, patios or private gardens.</p>	<p>C195</p> <p>Each dwelling is provided with enough high quality useable open space to meet the reasonable needs of residents and communal open space is of a scale appropriate to the development.</p>
<p>There is no applicable rule.</p>	<p>C196</p> <p>Large-scale redevelopments, where basement parking is provided, include a centrally located communal landscaped area occupying a minimum of 20% of the total site area. This area does not include remnant side or rear strips that are not physically and visually incorporated into the central landscaped zone.</p>
<b>5.2 Private Open Space</b>	
<p>R197</p> <p>At least one area of private open space is provided per dwelling to meet the following minimum area and dimension requirements:</p> <ol style="list-style-type: none"> <li>a) Lower floor level - 16 m<sup>2</sup> with a minimum dimension of 4m</li> <li>b) Upper floor levels - 6 m<sup>2</sup> with a minimum dimension of 1.8m.</li> </ol>	<p>This is a mandatory requirement. There is no applicable criterion.</p>
<p>R198</p> <p>Private open space is directly accessible from a main daytime living area of the dwelling.</p>	<p>This is a mandatory requirement. There is no applicable criterion.</p>
<b>5.3 Landscape</b>	
<p>There is no applicable rule.</p>	<p>C199</p> <ol style="list-style-type: none"> <li>a) Minimisation of extensive hard surfaced areas such as exposed concrete</li> <li>b) Screening of parking and service areas</li> </ol>

Rules	Criteria
	<ul style="list-style-type: none"> <li>c) Softening of hard surface areas by significant shrubs and tree planting</li> <li>d) Improving privacy of adjacent developments and dwellings, and minimising overlooking</li> <li>e) Provision of advanced specimens to ensure high quality landscape following construction</li> <li>f) Retention of existing vegetation where practicable</li> <li>g) Provision of attractive and coordinated street furniture and facilities to meet user needs</li> </ul>

## Element 7: Services

### Intent:

To minimise the visual impact of services and service areas from the street and within the new development

Rules	Criteria
<b>7.1 Easements and Utilities</b>	
R200 Electrical and telecommunications reticulation are underground.	This is a mandatory requirement. There is no applicable criterion.
R201 Electrical substations, switching stations and similar utilities are not located in streets and are screened from public view.	This is a mandatory requirement. There is no applicable criterion.

## Part C(5) - Multi Unit Housing – Other Areas – RZ4 and RZ5 Zones and All Areas in the Commercial Zones

This Part of the Code applies to development applications for multi unit housing in the RZ4 – Medium Density Residential and RZ5 – High Density Residential Zones as they apply in Belconnen, Bruce, Hawker, Narrabundah, Woden District and Tuggeranong District. These controls apply instead of those contained in Part C(1) of the Code. Parts A and B of this Code also apply.

This Part of the Code also applies to development applications for multi unit housing in the CZ1 – Core, CZ2 – Business, CZ3 – Services, CZ4 Local Centre, CZ5 – Mixed Use and CZ6 – Leisure and Accommodation Zones. The requirements should be read in conjunction with the relevant Commercial Codes. Parts A and B of the relevant Commercial Zone Development Code or Precinct Code replace Parts A and B of this Code for development in the Commercial Zones.

### Element 3: Built Form

#### Intent:

- a) To promote housing diversity by incorporating a range of apartment types and sizes within developments
- b) To provide building entries that are easily identifiable, assist in the identity and legibility of the development, and contribute to an appropriate streetscape response

Rules	Criteria
<b>3.1 Accommodation Diversity</b>	
R202 Residential developments contain a combination of dwelling types, including studio or 1-bedroom dwellings, 2-bedroom dwellings, and dwellings with 3+ bedrooms.	C202 Buildings contain a diversity of apartment types within developments to cater for different household requirements.
There is no applicable rule.	C203 Building design incorporates a diversity of floor plan layouts for each dwelling type and responds to site conditions, interface with adjoining development, aspect and orientation.
R204 Minimum dwelling floor areas are as follows: i) studio dwellings: 40 m <sup>2</sup> ii) one-bedroom dwellings: 50 m <sup>2</sup> iii) two-bedroom dwellings: 70 m <sup>2</sup> iv) three+ bedroom dwellings: 95 m <sup>2</sup> . The minimum dwelling floor area excludes balconies and car parking facilities. Storage within dwellings is included in the area calculations.	C204 Dwelling layouts provide functional living spaces, flexibility in furniture layout, and maintain good natural ventilation and day lighting. Studio apartments less than 40 m <sup>2</sup> may be considered where there is adequate provision of shared facilities, for example, open space, laundry, lounge, storage.

Rules	Criteria
<p>R205</p> <p>At least 10% of the dwellings of any multi-unit housing development consisting of 10 or more dwellings are designed to comply with the provisions of the Australian Standards and the Access and Mobility General Code.</p>	<p>C205</p> <p>Residential development is easily adaptable to suit the needs of people with disabilities and to meet the needs of Canberra's ageing population.</p>
<b>3.2 Entries</b>	
<p>R206</p> <p>Common entries servicing multiple dwellings establish a transitional area from the street or internal pathways by providing:</p> <ul style="list-style-type: none"> <li>a) a secure lift or stair lobby with a minimum floor space measuring 2 x 2 m at the lift or stair entry</li> <li>b) an external sheltered area at the entry to the common entry</li> <li>c) a clear line of sight between the lobby and the street or internal pathway.</li> </ul>	<p>C206</p> <p>Development provides a clear sense of address for common and dwelling entries, sheltered external spaces and secure foyer spaces (refer Figure C2).</p>
<p>R207</p> <p>Multiple entries to the development are provided where front boundary setbacks are less than 6 m and the frontage is more than 15 m long. Multiple entries may include residential common entries, individual ground floor dwelling entries, and entries to non-residential uses.</p>	<p>C207</p> <p>Development provides multiple entries along a street to promote activity on and surveillance of the street.</p>
<p>R208</p> <p>Common and individual dwelling entries have separate access from non-residential uses, which are clearly distinguishable and secured after hours.</p>	<p>C208</p> <p>Development provides safety and security for residents and visitors in entry and circulation areas.</p>
<p>R209</p> <p>The finished floor levels of common entries are at a level that is equal to, or higher than, the verge level adjoining the development and have a continuous accessible path of travel between the street and ground floor. Any level change at the entry occurs within the building, while continuing to meet access requirements.</p>	<p>This is a mandatory requirement. There is no applicable criterion.</p>

Rules	Criteria
<b>3.3 Interface</b>	
<p>R210</p> <p>Minimum dimensions between primary and secondary windows and balconies (Figure C3) (both within a development and between adjoining sites), are as follows:</p> <p>a) primary window/balcony to primary window/balcony:</p> <p>i) up to four storeys or 12 m high: 12 m</p> <p>ii) five to eight storeys or up to 25 m high: 18 m</p> <p>iii) nine storey and above or over 25 m: 24 m</p> <p>b) primary window/balcony to secondary window/balcony:</p> <p>i) up to four storeys or 12 m high: 9 m</p> <p>ii) five to eight storeys or up to 25 m high: 13 m</p> <p>iii) nine storeys and above or over 25 m high: 18 m</p> <p>c) Secondary window/balcony to secondary window/balcony:</p> <p>i) up to four storeys or 12 m high: 6 m</p> <p>ii) five to eight storeys or up to 25 m: 9 m</p> <p>iii) nine storeys and above or over 25 m high: 12 m</p> <p>d) On a side or rear boundary where redevelopment is likely, half the interface distances will apply as a side boundary setback.</p> <p>e) No interface controls apply for blank walls.</p>	<p>C210</p> <p>External spaces between buildings are appropriately proportioned to contribute to visual privacy, solar access, wind mitigation, and amenity of outdoor spaces.</p>

#### Element 4: Parking and Site Access

##### Intent:

- a) To promote a sense of community and safety by providing opportunities for interaction between residents
- b) To design circulation routes, individual apartment entries and car-parking facilities that provide simple, safe, secure and direct access for both residents and visitors
- c) To integrate the location and design of car parking within the site and the building

Rules	Criteria
<b>4.1 Circulation</b>	
<p>There is no applicable rule.</p>	<p>C211</p> <p>Clear lines of sight and well-lit circulation routes are provided throughout the development, particularly for:</p> <ul style="list-style-type: none"> <li>a) routes from car-parking areas</li> <li>b) common entries and corridors</li> <li>c) communal areas</li> <li>d) lift and stair lobbies to the apartments.</li> </ul>
<p>R212</p> <p>Common circulation areas achieve the following minimum dimensions:</p> <ul style="list-style-type: none"> <li>a) a common lobby area with a minimum floor space measuring 2 x 2 m at the lift or stair entry (not applicable to a fire stair, which is in addition to a lift or a main stair access)</li> <li>b) corridor lengths up to 4 m from a common lobby: 1.5 m width</li> <li>c) corridor lengths up to 8 m from a common lobby: 1.8 m width</li> <li>d) corridor lengths greater than 8 m from a common lobby: 2.0 m width</li> </ul>	<p>C212</p> <p>The development:</p> <ul style="list-style-type: none"> <li>a) achieves a high level of amenity to common circulation areas</li> <li>b) includes well-proportioned lobbies and corridors</li> <li>c) provides for the convenient movement of people and furniture.</li> </ul>
<p>R213</p> <p>Apartment buildings without lift access have a maximum stair rise of three storeys. An extra storey is permitted only where access is available from within third storey apartments (refer Figure C4).</p>	<p>This is a mandatory requirement. There is no applicable criterion.</p>
<p>R214</p> <p>Where apartments are accessible from a common lift or stair lobby, floor levels contain no more than nine apartments.</p>	<p>C214</p> <p>Individual Apartment entries are to be clearly identifiable, provide simple, safe, secure, direct access for both residents and visitors and the development is to achieve</p> <ul style="list-style-type: none"> <li>a) a high level of public amenity and safety in common lobbies,</li> <li>b) a high level of amenity within the apartments,</li> <li>c) an appropriate streetscape response.</li> </ul>

Rules	Criteria
There is no applicable rule.	<p>C215</p> <p>Apartments with entries that open directly onto common spaces or public areas are to be clearly visible from the development entry and provided with transitional areas such as a verandah, porch or like element and provide direct, secure, all-weather access to apartments.</p>
<b>4.2 Parking</b>	
<p>R216</p> <p>a) Access to residential car parking facilities is separated from non residential delivery and service vehicle facilities.</p> <p>b) The maximum horizontal travel distance between dwelling entries and associated residents' car parking spaces is 60 m.</p> <p>c) Convenient stair access to common entries is provided from basement car parking facilities in addition to any lift access that is provided.</p>	<p>C216</p> <p>The location and design of car parking is to be integrated with the design of the site and the building and provide safe and convenient car parking for residents.</p>
<p>R217</p> <p>Visitor parking is to be easily accessible, located independent of secured resident parking and allow visitors safe and direct pedestrian entry to common building entries</p> <p>Visitor parking facilities in basement levels are located separately from secured resident parking and before any security barriers.</p> <p>For developments with more than 50 dwellings, short stay parking is provided for large furniture delivery and removalist vans.</p>	<p>C217</p> <p>Visitor parking facilities allow visitors safe and direct pedestrian access to the common entries.</p>
<p>R218</p> <p>Car-parking facilities and vehicular access routes are:</p> <p>a) separated from windows to habitable rooms and external block boundaries by a minimum of 1.5 m</p> <p>b) This set back may be reduced to 1.0m where there is an intervening fence with a minimum height of 1.5m or where the window sill is greater than 1.5m above the internal road, driveway or car park.</p>	<p>C218</p> <p>Site layout separates, by way of barriers, and/or by distance parking areas and driveways to limit vehicle light spill and minimise external noise entering dwellings.</p>



## Element 5: Amenity

### Intent:

- a) To ensure building envelopes and apartment layouts are designed to maximise solar access, natural ventilation and daylight
- b) To ensure a proposed development reasonably anticipates likely future redevelopment on adjoining sites and does not compromise it
- c) To enhance residential amenity through design, siting and planting of areas of open space
- d) To respect, retain and conserve the important existing streetscape elements in established areas
- e) To ensure landscape and infrastructure development contributes to the energy efficiency, safety, and sustainability of the development
- f) To site and design apartment buildings and associated open spaces to provide visual and acoustic privacy, and to protect the privacy of neighbours

Rules	Criteria
<b>5.1 Visual Privacy</b>	
<p><b>R219</b></p> <p>Windows and balconies of an upper floor level apartment are to be designed to prevent overlooking of more than 50% of the private open space of a lower floor level apartment, either within the same development or adjoining development.</p> <p>Any primary window located within a screening zone (refer Figure C5) between different apartments is to be designed to prevent direct views between the habitable rooms and private open spaces of apartments on the same floor or floors below. The screening zone is determined by a 9m horizontal distance for the outer edge of a window to a habitable room or balcony within a 45° angle.</p>	<p><b>C219</b></p> <p>The design and siting of the development maximises visual privacy by avoiding overlooking through the effective location of windows, balconies and ground floor private open spaces.</p>
<p><b>R220</b></p> <p>Screening devices such as opaque screens, perforated panels, trellises, high windowsills or obscure glass are not used to prevent overlooking of main internal living areas and private open space of other dwellings.</p>	<p><b>C220</b></p> <p>Developments that require screening devices to achieve visual privacy may be considered where it is demonstrated that building design and siting or landscape screening can not achieve visual privacy and where screening devices are integrated into the building design.</p>
<b>5.2 Solar Access</b>	
<p><b>R221</b></p> <p>Any building opposite a window to a habitable room is limited in height by a plane projected at 60° above horizontal from 750mm above the floor</p>	<p><b>C221</b></p> <p>Buildings are to be sited and designed to provide adequate daylight to habitable rooms and minimise energy consumed for heating and</p>

Rules	Criteria
<p>level at the window for a lateral distance defined by a 60° arc from the centre of the window.</p> <p>Where a building opposite a window to a habitable room does not meet the above control a development may be considered if certification by a suitably qualified person is provided indicating that an average daylight factor of 2.5% across a minimum of 60% of habitable room area is achieved.</p>	cooling.
<p>R222</p> <p>Development is sited to allow a minimum of 3 hours of direct sunlight onto the floor or internal wall of the main daytime living area and the front edge of any associated private open space of at least 70% of apartments between the hours of 9.00am and 3.00pm on 21 June (Winter Solstice).</p>	<p>C222</p> <p>Buildings are to be sited and designed to optimise solar access to north facing windows of living areas and to private open space.</p>
<p>R223</p> <p>When windows are located on west facing facades, external shading is integrated into the building design to protect windows from direct sunlight in summer. Other energy saving measures such as new glass technology must be in addition to external shade protection.</p>	<p>C223</p> <p>Optimum winter sunlight is provided to west-facing windows of living areas and appropriate shading is provided in summer.</p>
<p><b>5.3 Neighbourhood Plans</b></p>	
<p>There is no applicable rule.</p>	<p>C224</p> <p>Where a Neighbourhood Plan exists, development demonstrates response to the key strategies and actions of the relevant Neighbourhood Plan.</p>
<p><b>5.4 Natural Ventilation</b></p>	
<p>There is no applicable rule.</p>	<p>C225</p> <p>Apartment layouts are to ensure natural ventilation is provided to habitable rooms by cross or stack effect ventilation by maximising separation between opening windows.</p>

Rules	Criteria
<p>R226</p> <p>Habitable rooms, not including kitchens, achieve the following minimum ceiling heights (refer Figure C6):</p> <ul style="list-style-type: none"> <li>a) for room depth from window up to 6 m: 2.4 m minimum ceiling height</li> <li>b) for room depth from window up to 9 m: 2.7 m minimum ceiling height</li> <li>c) for room depth from window &gt; 9 m: 3 m minimum ceiling height.</li> </ul>	<p>C226</p> <p>Ceiling heights in apartments are to maximise natural ventilation and daylighting of habitable rooms in apartments.</p>
<p>R227</p> <p>Studies or media rooms without direct access to natural ventilation and daylighting are to have:</p> <ul style="list-style-type: none"> <li>a) A maximum floor area of 9m<sup>2</sup></li> <li>b) Wide double doors with louvres for ventilation</li> <li>c) Built-in joinery such as a computer desk.</li> </ul>	<p>C227</p> <p>Studies or media rooms without direct access to natural ventilation and daylighting may be considered where it can be demonstrated that they cannot be used as a bedroom.</p>
<b>5.5 Noise</b>	
<p>R228</p> <p>Design and construction is to comply with relevant sections of</p> <ul style="list-style-type: none"> <li>a) AS/NZS 3671 Acoustics – Road traffic noise intrusion, building siting and construction</li> <li>b) AS/NZS 2107 Acoustics – Recommended design sound levels and reverberation terms for building interiors,</li> <li>c) ACT Environment Protection Regulations 1997</li> <li>d) ACT Draft Noise Management Guideline 1996</li> </ul>	<p>This is a mandatory requirement. There is no applicable criterion.</p>
<p>R229</p> <p>Siting and configuration of development components is to separate, by barriers, distance and/or by design, noise sensitive sleeping and living areas and private open spaces from noise producing areas such as:</p> <ul style="list-style-type: none"> <li>a) Active recreational areas like swimming pools and tennis courts,</li> <li>b) Vehicle movement areas like parking, driveways, roller doors and,</li> </ul>	<p>C229</p> <p>Apartment buildings and associated open spaces are to be sited and design to provide acoustic privacy and to protect the privacy of neighbours.</p>

Rules	Criteria
c) Service equipment areas like pump maintenance, garbage collection.	
<p>R230</p> <p>A construction element that separates, or at some stage in the future could separate, non-residential uses from residential apartments have a method of construction which can achieve the following design sound reduction standards:</p> <p>a) Airborne Sound Design: <math>R_w + C_{tr}</math> of not less than 55 for walls and floors.</p> <p>b) Impact Sound Design: <math>L'_{nT,w}</math> of not more than 45 for floors when the non-residential use is located above the residential use: and <math>L'_{nT,w}</math> of not more than 50 for floors when the commercial use is located below the residential use.</p>	<p>C230</p> <p>Apartments near other uses are designed with regard to the potential noise from those activities by locating noise-sensitive sleeping and living areas and private open spaces away from the noise source and by incorporating appropriate noise reduction measures in the construction of the buildings.</p>
<p>R231</p> <p>Continuous noise from air conditioning mechanical ventilation or other equipment that is provided within an apartment as part of the building should not exceed 35dB(A) in bedrooms or 40dB(A) in other rooms of that apartment, in accordance with the procedures of AS/NZS 2107.</p>	<p>This is a mandatory requirement. There is no applicable criterion.</p>
<b>5.6 Private Open Space</b>	
<p>R232</p> <p>Private open space for each dwelling on the ground and podiums is provided and meets the following requirements:</p> <p>a) minimum area: 24 m<sup>2</sup></p> <p>b) minimum width: 4 m opening directly off a daytime living area.</p> <p>Note: Space for service functions, such as air conditioners and clothes drying, is additional to this minimum areas specified above.</p>	<p>C232</p> <p>Private open space is provided and is clearly defined, useable, and meets requirements for privacy, access, outdoor activities, and landscaping.</p> <p>For the CZ1 Core, CZ2 Business and CZ3 Services Zone where it can be demonstrated that surrounding commercial development will impact on the amenity of ground floor private open space, the Authority may consider reducing the amount of private open space provided.</p>
<p>R233</p> <p>Private open space for each upper floor dwelling is provided in the form of a balcony which meets the following requirements:</p> <p>a) minimum area of balcony: 6 m<sup>2</sup></p>	<p>C233</p> <p>Private open space is clearly defined, useable and meets requirements for privacy, access, and outdoor activities.</p>

Rules	Criteria
<p>b) minimum width of 1.8 m opening directly off a daytime living area.</p> <p>Note: Space for service functions, such as air conditioners and clothes drying, is additional to the minimum areas specified above.</p>	
<p>R234</p> <p>Private open spaces at ground and podium levels are designed and located to achieve a minimum of 3 hours of direct sunlight to a minimum of 50% of the area between the hours of 9.00 am and 3.00 pm on 21 June (Winter Solstice).</p>	<p>C234</p> <p>Private open space is to provide for maximum year round use.</p>
<p>R235</p> <p>All balconies/terraces are integrated into the overall architectural form and detail of the building. Integration of balconies do not negatively impact on solar access to apartments.</p>	<p>C235</p> <p>Private open spaces are to visually enhance the buildings and their setting.</p>
<p>R236</p> <p>Fully transparent balustrade construction is not used on balconies for the first four floor levels above street level.</p>	<p>C236</p> <p>Private open spaces at lower floors provide privacy to residents and screen household items.</p>
<p><b>5.7 Communal Open Space</b></p>	
<p>There is no applicable rule.</p>	<p>C237</p> <p>The centrally located communal open space is:</p> <ul style="list-style-type: none"> <li>a) directly accessible from common entries</li> <li>b) readily accessible to all residents</li> <li>c) designed to provide for passive surveillance</li> <li>d) designed to screen views into adjacent dwellings and their private open space</li> <li>e) able to be maintained and managed with minimal impact on the amenity of residents</li> <li>f) able to provide for larger plants with deep root systems.</li> </ul>
<p>There is no applicable rule.</p>	<p>C238</p> <p>Sufficiently deep soil zones are provided within the common open space to enable the establishment and healthy growth of deep-rooted plants into natural subsoil.</p>

Rules	Criteria
<p>R239</p> <p>An area of communal open space is provided that is centrally located and comprises at least 20% of the total site area. The calculation of the communal open space area is not to include front setbacks or narrow strips of residual land that are not visually or physically incorporated into the area, or areas not readily accessible by residents.</p>	<p>C239</p> <p>Communal open space is clearly defined, useable and meets requirements for privacy, access, outdoor activities and landscaping</p> <p>Communal open space may include shared indoor facilities for use by all residents, such as gymnasiums, pools, reading rooms and lounge rooms.</p>
<p>There is no applicable rule.</p>	<p>C240</p> <p>A proposal providing less than 20% common open space may be considered where:</p> <ul style="list-style-type: none"> <li>a) Communal open space is clearly defined, useable and meets user requirements for privacy, access, outdoor activities and landscaping;</li> <li>b) Appropriate shared indoor facilities are provided for use by all residents in lieu of outdoor space, including a gymnasium, pool, reading room and/or lounge room;</li> <li>c) There are less than 20 apartments;</li> <li>d) The site is in a constrained urban area; or</li> <li>e) The site adjoins a large area of public open space.</li> </ul>
<p>There is no applicable rule.</p>	<p>C241</p> <p>To contribute to the quality and amenity of open space on rooftops and car park structures adequate soil depths are provided to support appropriately scaled trees and/or trellises and shade structures that support climbing plants.</p>
<p>R242</p> <p>On major avenues, where a proposal is not built to the side boundary, at least one side boundary setback should be available for deep rooted planting.</p>	<p>This is a mandatory requirement. There is no applicable criterion.</p>

## Element 7: Services

### Intent:

- a) To provide a convenient area suitable for storage of everyday household items within easy access of the apartment
- b) To ensure a minimum space provision for sporting, leisure fitness and hobby equipment

- c) To ensure clothes drying facilities are appropriately screened from public view
- d) To locate common and private services to maintain streetscape and residential amenity

Rules	Criteria
<b>7.1 Lighting</b>	
There is no applicable rule.	<p>C243</p> <p>Lighting to external circulation routes, dwelling entries, driveways and car parks is legible and provides for personal safety and security.</p>
<b>7.2 Mailboxes</b>	
<p>R244</p> <p>Mailboxes for dwellings are located at street entries to residential developments and comply with the requirements of <i>Australia Post Terms and Conditions</i>, 'Appendix 2: Street Mail Service – Conditions of Delivery'.</p>	<p>C244</p> <p>Mailboxes are located for convenient access by residents and deliverers with passive surveillance from the street or from active uses.</p>
<b>7.3 Clothes Drying</b>	
There is no applicable rule.	<p>C245</p> <p>External clothes drying facilities are provided in the form of:</p> <ul style="list-style-type: none"> <li>a) open-air, communal clothes drying facilities that are easily accessible for all residents and visually screened from public areas</li> <li>b) an area of 2 m<sup>2</sup>, in addition to the minimum private open space requirement for private balconies, and screened from view from on-site and external open spaces.</li> </ul>
<b>7.4 Storage</b>	
<p>R246</p> <p>Storage facilities are provided at the following minimum rates:</p> <ul style="list-style-type: none"> <li>a) studio and one-bedroom dwellings: 4 m<sup>2</sup> with a minimum height of 2 m</li> <li>b) two and three+ bedroom dwellings: 5 m<sup>2</sup> with a minimum height of 2 m.</li> </ul> <p>At least 50% of the total storage area is provided within apartments and is accessible from either the hall or living areas.</p>	<p>C246</p> <p>Dwellings are provided with adequate secure storage areas.</p>

Rules	Criteria
There is no applicable rule.	<p>C247</p> <p>Where bicycle storage is provided within the dwelling storage rate, the storage is configured to allow for unimpeded storage and removal of bicycles.</p>



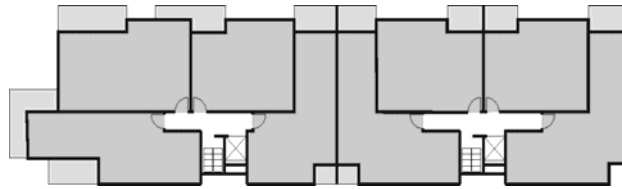

Higher amenity is created through multiple common building entries that creates a high proportion of dual aspect apartments

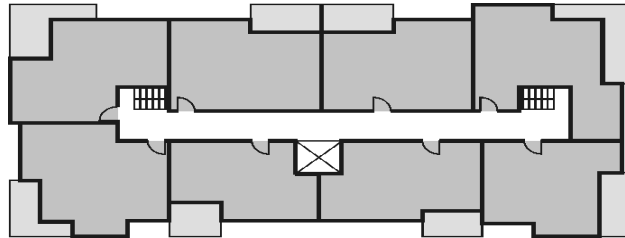

Lower amenity is created by a double loaded corridor that increases proportion of single aspect apartments

**Figure C2 Shared Entries**

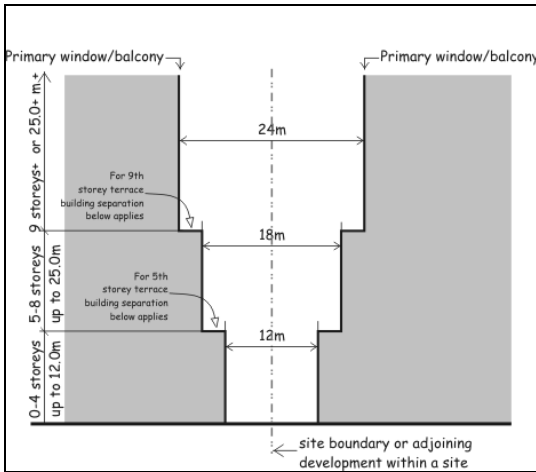

Primary /Primary window interface

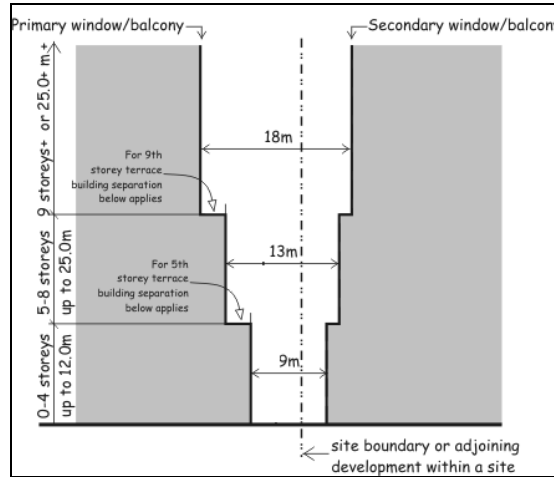

Primary /Secondary window interface

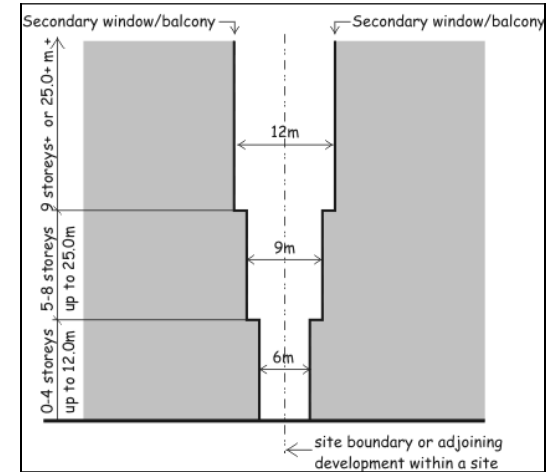

Secondary /secondary window interface

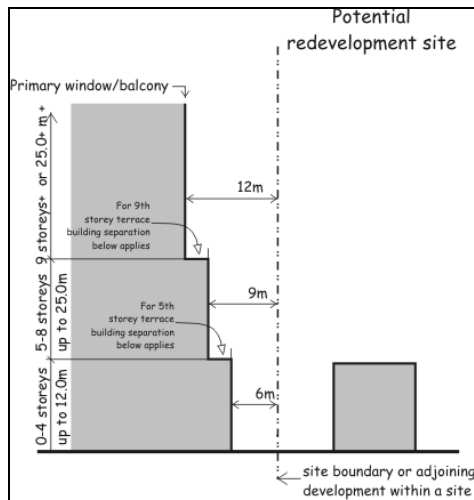

Primary window interface with adjoining potential development site

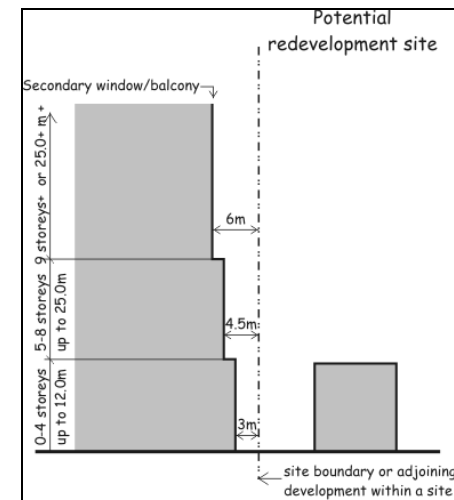

Secondary window interface with adjoining potential development site

### Figure C3 Building Interfaces

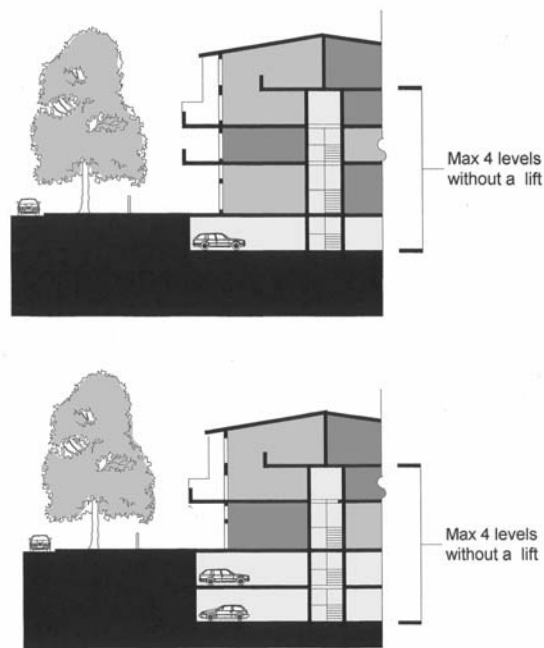

Walk-up apartment buildings: The path of travel from either ground floor building entry or from basement car parks to the front door of an apartment is a maximum of stair rise of three storeys (including basement car park levels).

**Figure C4 Buildings Without Lift Access**

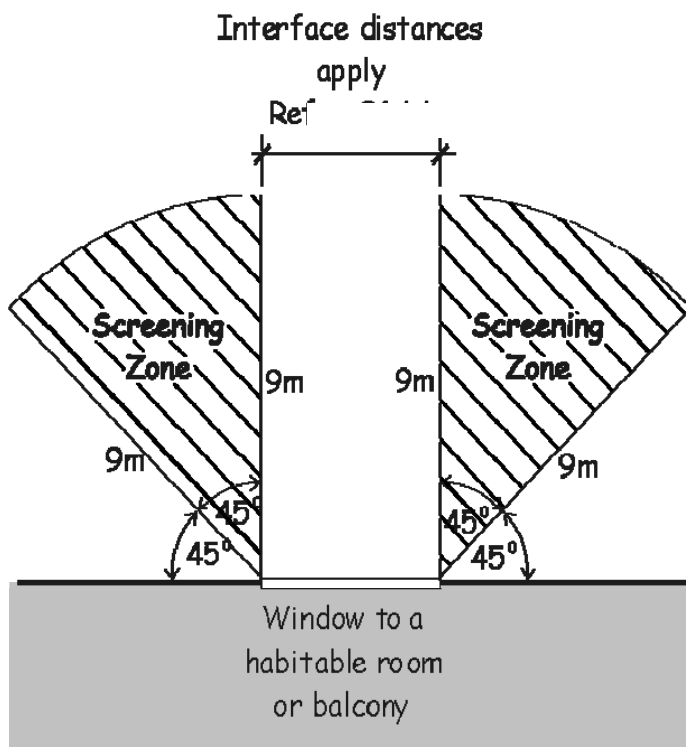

**Figure C5 Screening Zones**

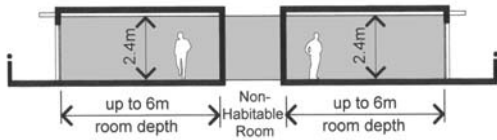

Ceiling height and room depth up to 6m

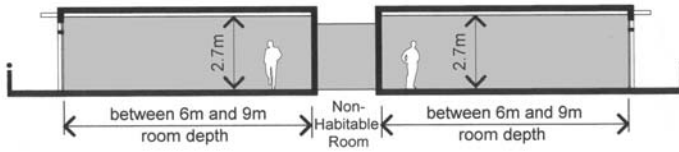

Ceiling height and room depth between 6m and 9m

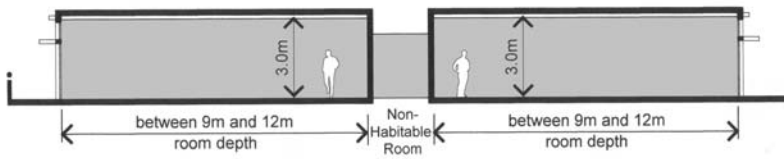

Ceiling height and room depth between 9m and 12m

**Figure C6 Ceiling Heights and Room Depths**

## Part D - Development Type Controls - Other Forms of Residential Development and Non-Residential Development

This Part of the Code applies to development applications for other forms of residential development (not including single dwelling housing) and for non-residential development in all Residential Zones. Parts A and B of this Code also apply as does C(1) of the Residential Zones – Single Dwelling Housing Development Code.

### Element 1: Restrictions on Use

#### Intent:

- a) To protect the amenity of the area by restricting the agglomeration of non residential and other forms of residential activities
- b) To ensure the development is of a compatible scale with surrounding residential development and residential character of the locality (being predominantly detached housing)
- c) To ensure ease of access to essential non residential activities
- d) The community's lifecycle housing needs are met through well-designed adaptable housing
- e) To provide for a range of residential forms whilst maintaining the residential character of the locality

Rules	Criteria
<b>1.1 Development Standards</b>	
R248 Except as expressly provided for in any Item to this Element, the provisions of Parts A and B of this Code and Part C(1) of the Residential Zones – Single Dwelling Housing Development Code apply to development identified in this Element.	This is a mandatory requirement. There is no applicable criterion.
<b>1.2 Plot Ratio</b>	
There is no applicable rule.	C249 Notwithstanding any other provisions relating to plot ratio, on land where a lawfully constructed building exceeds the stipulated maximum plot ratio, a new building or buildings up to the same plot ratio may be permitted subject to consideration of any adverse impact resulting from increase in building bulk and providing that the development does not involve an increase in the number of dwellings on the land.
<b>1.3 Habitable Suite</b>	
R250 The applicant submits a statutory declaration	C250

Rules	Criteria
<p>stating that, while the habitable suite is occupied as a separate domicile, it will be occupied only by a person who is providing care to or receiving care from an occupant of the main dwelling for reasons of infirmity (due to age) or disability.</p>	<p>This is a mandatory requirement. There is no merit criterion.</p>
<p>There is no applicable rule.</p>	<p>C251</p> <p>a) It is demonstrated and documented how the habitable suite will be integrated into the dwelling, and how kitchen facilities will be removed when the care is no longer required.</p>
<p>R252</p> <p>The habitable suite is as follows:</p> <p>a) permitted only on a block on which a single dwelling is erected</p> <p>b) complies with all relevant items in Parts A and B of this Code and Part C(1) of the Residential Zones – Single Dwelling Housing Development Code.</p>	<p>This is a mandatory requirement. There is no applicable criterion.</p>
<p>R253</p> <p>The habitable suite is as follows:</p> <p>a) maximum gross floor area of 70m<sup>2</sup></p> <p>b) 1 parking space in addition to that required by the main dwelling</p>	<p>C253</p> <p>To protect the single dwelling housing character and amenity of predominantly detached housing areas.</p>
<p><b>1.4 Relocatable Unit</b></p>	
<p>R254</p> <p>The applicant submits a statutory declaration stating that, while the relocatable unit is occupied as a separate domicile, it will be occupied only by a person who is providing care to or receiving care from an occupant of the main dwelling for reasons of infirmity (due to age) or disability.</p>	<p>This is a mandatory requirement. There is no applicable criterion.</p>
<p>R255</p> <p>The relocatable unit is as follows:</p> <p>a) permitted only on a block on which a single dwelling is erected</p> <p>b) complies with all relevant items in Parts A and B of this Code and Part C(1) of the Residential Zones – Single Dwelling Housing Development Code.</p>	<p>This is a mandatory requirement. There is no applicable criterion.</p>

Rules	Criteria
<p>R256</p> <p>a) The relocatable unit is as follows:</p> <ul style="list-style-type: none"> <li>i) maximum gross floor area of 70 m<sup>2</sup></li> <li>ii) 1 parking space in addition to that required by the main dwelling</li> <li>iii) the unit is sited and designed so that:</li> <li>iv) the wall height does not exceed 3.5 m</li> <li>v) it is at the rear of the main dwelling.</li> </ul> <p>b) The minimum setback from any window or opening in a wall of the main dwelling is 3.5 m.</p>	<p>C256</p> <p>To protect the single dwelling housing character and amenity of predominantly detached housing areas.</p>
<b>1.5 Boarding House, Child Care Centre, Community Activity Centre and Residential Care Accommodation</b>	
<p>There is no applicable rule.</p>	<p>C257</p> <ul style="list-style-type: none"> <li>a) It is demonstrated that the use will not have a significant adverse impact on surrounding residential development.</li> <li>b) The building form and materials have a domestic character and scale compatible with the locality.</li> </ul> <p><u>Exception:</u> These criteria are not applicable to childcare centres in Belconnen, Section 55, Block 37, Section 66, Section 67, Block 3, and part Block 2, and Section 88, part Block 1.</p>
<p>R258</p> <p>These uses are permitted only where:</p> <ul style="list-style-type: none"> <li>a) there is a maximum of 1 of these uses per section</li> <li>b) there is a maximum plot ratio of 35%</li> </ul> <p><u>Exception:</u> These rules are not applicable to childcare centres in Belconnen, Section 55, Block 37, Section 66, Section 67, Block 3, and part Block 2, and Section 88, part Block 1.</p>	<p>C258</p> <p>To protect the amenity of the areas by restricting the agglomeration of non residential activities and to ensure that the development is of a compatible scale with surrounding residential development.</p>
<b>1.6 Supportive Housing</b>	
<p>There is no applicable rule.</p>	<p>C259</p> <ul style="list-style-type: none"> <li>a) It is demonstrated that the use will not have a significant adverse impact on surrounding residential development.</li> <li>b) The building form and materials have a domestic character and scale compatible</li> </ul>

Rules	Criteria
	with the locality.
<p>R260</p> <p>In the RZ1 Zone, on a <i>standard block</i>, all dwellings are designed to meet the relevant Australian Standard or building code for adaptable housing.</p>	<p>This is a mandatory requirement. There is no applicable criterion.</p>
<p>R261</p> <p>In the RZ1 Zone, on a <i>standard block</i>, the maximum plot ratio is 35%.</p>	<p>This is a mandatory requirement. There is no applicable criterion.</p>
<b>1.7 Guest House</b>	
<p>R262</p> <p>Guest houses are permitted only:</p> <ol style="list-style-type: none"> <li>a) at a maximum of 1 per section and only where adjacent to a commercial zone</li> <li>b) on blocks abutting Northbourne Avenue in Downer, Sections 34 and 44</li> <li>c) in Belconnen Section 55, Block 37, Section 66, Section 67, Block 3 and part Block 2, and Section 88, part Block 1</li> </ol>	<p>This is a mandatory requirement. There is no applicable criterion.</p>
<b>1.8 Health Facility</b>	
<p>R263</p> <p>A health facility is permitted where:</p> <ol style="list-style-type: none"> <li>a) there is a maximum of one per section</li> <li>b) it is adjacent to a group centre or local centre; or</li> <li>c) in Belconnen, Section 55, Block 37, Section 66, Section 67, Block 3 and part Block 2, and Section 88, part Block 1.</li> </ol>	<p>C263</p> <p>To protect the amenity of the areas by restricting the agglomeration of non residential activities to ensure that health facilities are located in areas which are easily and safely accessible.</p> <p><u>Exception:</u> These criteria are not applicable in Belconnen, Section 55, Block 37, Section 66, Section 67, Block 3, and part Block 2, and Section 88, part Block 1.</p>
<b>1.9 Business Agency, Office, Restaurant, Shop</b>	
<p>R264</p> <p>A business agency, office, restaurant, shop are permitted only where:</p> <ol style="list-style-type: none"> <li>a) the gross floor area for these purposes in any section does not exceed 100m<sup>2</sup> in total</li> <li>b) the business agency, office, restaurant or shop is part of an integrated mixed use development that includes multi-unit housing</li> <li>c) on approval of the subject development, the proportion of the total land area of the section that has been approved for multi-unit</li> </ol>	<p>This is a mandatory requirement. There is no applicable criterion.</p>



Rules	Criteria
housing, including dual occupancy, is not less than 75%.	
<b>1.10 Home Business</b>	
R265 There is no applicable rule.	C265 <i>A home business</i> meets the requirements contained in the Home Business General Code,
<b>1.11 Barton, Section 17, Block 4</b>	
R266 The maximum height of buildings in Barton, Section 17, Block 4 is one storey.	This is a mandatory requirement. There is no applicable criterion.
<b>1.12 Use of Buildings – Narrabundah, Section 100, Blocks 11, 12, 37, 44, 45, 2, 19, 21 and 20</b>	
R267 Buildings associated with the previous use of the site as a school may be used for offices of sporting, cultural, social or other ACT Government or non-profit community based organisations.	This is a mandatory requirement. There is no applicable criterion.