



Australian Capital Territory

# Scaffolding and Lifts Regulation 1950

made under the

**Scaffolding and Lifts Act 1912**

**Republication No 4**

**Effective: 12 April 2007 – 30 September 2009**

Republication date: 12 April 2007

Last amendment made by A2007-3

## About this republication

### The republished law

This is a republication of the *Scaffolding and Lifts Regulation 1950*, made under the *Scaffolding and Lifts Act 1912* (including any amendment made under the *Legislation Act 2001*, part 11.3 (Editorial changes)) as in force on 12 April 2007. It also includes any amendment, repeal or expiry affecting the republished law to 12 April 2007.

The legislation history and amendment history of the republished law are set out in endnotes 3 and 4.

### Kinds of republications

The Parliamentary Counsel's Office prepares 2 kinds of republications of ACT laws (see the ACT legislation register at [www.legislation.act.gov.au](http://www.legislation.act.gov.au)):

- authorised republications to which the *Legislation Act 2001* applies
- unauthorised republications.

The status of this republication appears on the bottom of each page.

### Editorial changes

The *Legislation Act 2001*, part 11.3 authorises the Parliamentary Counsel to make editorial amendments and other changes of a formal nature when preparing a law for republication. Editorial changes do not change the effect of the law, but have effect as if they had been made by an Act commencing on the republication date (see *Legislation Act 2001*, s 115 and s 117). The changes are made if the Parliamentary Counsel considers they are desirable to bring the law into line, or more closely into line, with current legislative drafting practice.

This republication includes amendments made under part 11.3 (see endnote 1).

### Uncommenced provisions and amendments

If a provision of the republished law has not commenced or is affected by an uncommenced amendment, the symbol **U** appears immediately before the provision heading. The text of the uncommenced provision or amendment appears only in the last endnote.

### Modifications

If a provision of the republished law is affected by a current modification, the symbol **M** appears immediately before the provision heading. The text of the modifying provision appears in the endnotes. For the legal status of modifications, see *Legislation Act 2001*, section 95.

### Penalties

The value of a penalty unit for an offence against this republished law at the republication date is—

- (a) if the person charged is an individual—\$100; or
- (b) if the person charged is a corporation—\$500.



Australian Capital Territory

# Scaffolding and Lifts Regulation 1950

made under the

**Scaffolding and Lifts Act 1912**

## Contents

---

	Page	
<b>Part 1</b>	<b>Preliminary</b>	
1	Name of regulation	2
2	Dictionary	2
3	Notes	2
4	Plates, figures and sketches	2
5		2
6		3
7		4
<b>Part 2</b>	<b>Qualifications, powers and duties of the chief inspector and inspectors</b>	
11		5

---

R4  
12/04/07

Scaffolding and Lifts Regulation 1950  
Effective: 12/04/07-30/09/09

contents 1

Contents

---

	Page
13	5
14	6
<b>Part 4</b>	<b>Lifts</b>
<b>Division 4.1</b>	<b>Interpretation</b>
16	7
<b>Division 4.2</b>	<b>Design, construction and erection of lifts</b>
<b>Permit to erect or alter lifts</b>	
17	7
<b>Safe working load of a lift</b>	
18	8
<b>Construction</b>	
19	9
20	9
21	9
<b>Car loading automatic passenger lifts</b>	
22	10
<b>Supporting structures and machine rooms</b>	
23	10
<b>Overruns</b>	
24	11
<b>Stops and buffers</b>	
25	12
<b>Permanent stops</b>	
26	13
<b>Pits</b>	
27	13
<b>Enclosures</b>	
28	14
<b>Enclosure doors</b>	
29	14

---

	Contents
	Page
<b>Clearance in wells</b>	
30	15
<b>Ropes and sheaves</b>	
31	16
<b>Lift cars</b>	
32	17
<b>Car gates</b>	
33	18
<b>Lighting and ventilation of cars</b>	
34	19
<b>Safety gear</b>	
35	19
<b>Machines</b>	
36	20
<b>Counterweight</b>	
37	21
<b>Guides</b>	
38	21
<b>Electrical equipment</b>	
39	21
<b>Car switch</b>	
40	22
<b>Limit gear</b>	
41	22
<b>Slack cable device</b>	
42	23
<b>Safety gear switch</b>	
43	23
<b>Stop button</b>	
44	23

---

## Contents

---

	Page
<b>Signal call system</b>	
45	24
<b>Hydraulic equipment</b>	
46	24
<b>Escalators</b>	
47	25
<b>Trusses or girders</b>	
48	25
<b>Track arrangement</b>	
49	25
<b>Angle of inclination</b>	
50	26
<b>Balustrading</b>	
51	26
<b>Treads and landings</b>	
52	26
<b>Power unit</b>	
53	26
<b>Chains</b>	
54	27
<b>Automatic brakes</b>	
55	27
<b>Starting switch and stop button</b>	
56	27
<b>Safety devices</b>	
57	27
<b>Reverse phase relay</b>	
58	28
<b>Machine room</b>	
59	28

		Contents
		Page
<b>Construction of conveyors</b>		
60		28
<b>Electrical installation</b>		
61		29
<b>Control</b>		
62		29
<b>Enclosures</b>		
63		29
<b>Provision for maintenance</b>		
64		30
<b>No persons permitted to travel</b>		
65		30
<b>Load notice</b>		
66		30
<b>Division 4.3</b>	<b>Maintenance of lifts</b>	
67		30
<b>Division 4.4</b>	<b>Use of lifts</b>	
68		32
<b>Change of ownership</b>		
69		32
70		33
71		33
72		33
<b>Part 5</b>	<b>Safeguards and measures to be taken for securing the safety and health of persons engaged in building work</b>	
<b>Division 5.1</b>	<b>General</b>	
73		34
74		38
<b>Fencing of floors, landings, stairways and the like</b>		
75		39

---

R4 12/04/07	Scaffolding and Lifts Regulation 1950 Effective: 12/04/07-30/09/09	contents 5
----------------	-----------------------------------------------------------------------	------------

	Page
<b>Division 5.2      Constructing, erecting, adding to, altering, repairing, finishing, painting and cleaning buildings and structures</b>	
<b>Stability of walls</b>	
77	40
<b>Protection in liftwells and stairwells</b>	
78	40
<b>Temporary ramps</b>	
79	40
<b>Provision and use of ladders and stepladders</b>	
80	41
<b>Cleaning and maintenance of roof monitors, gutters, windows, louvres and ventilators</b>	
81	45
<b>Window cleaning</b>	
82	46
<b>Spray painting</b>	
83	60
<b>Division 5.3      Demolition of buildings and structures</b>	
84	66
<b>Part 6            The proper design, construction, erection and use of scaffolding</b>	
85      Definitions for pt 6	69
<b>General</b>	
86	70
<b>Construction of single and independent pole scaffolding</b>	
87	74
<b>Cantilever scaffolding</b>	
88	89
<b>Bracket scaffolding</b>	
89	91



		Contents
		Page
<b>Suspended scaffolding</b>		
90		95
<b>Light swinging stages</b>		
91		102
<b>Boatswain's chairs</b>		
92		107
<b>Scaffolding for use on ships in dock or on slips</b>		
93		109
<b>Runs and ramps</b>		
94		113
<b>Part 7</b>	<b>Safeguards and measures to be taken for securing the safety and health of persons engaged in excavation work</b>	
<b>Division 7.1</b>	<b>General</b>	
95		115
<b>Division 7.2</b>	<b>Cofferdams and caissons</b>	
96		118
<b>Division 7.3</b>	<b>Trenches</b>	
97		119
<b>Division 7.4</b>	<b>Shafts, wells and tunnels</b>	
98		121
<b>Part 8</b>	<b>Safeguards and measures to be taken for securing the safety and health of persons engaged in compressed air work</b>	
<b>Division 8.1</b>	<b>Diving</b>	
99		123
<b>Division 8.2</b>	<b>Tunnelling</b>	
100		139

Contents

---

	Page
<b>Division 8.3</b>	<b>Caissons</b>
101	153
<b>Part 9A</b>	<b>Explosive-powered tools—safety measures</b>
<b>Application and interpretation</b>	
118A	167
<b>Operators of explosive-powered tools</b>	
118B	168
<b>General requirements for explosive-powered tools and projectiles</b>	
118C	168
<b>Inspection and repair of explosive-powered tools</b>	
118D	169
<b>Use of explosive-powered tools</b>	
118E	171
<b>Care and storage of explosive-powered tools and cartridges</b>	
118F	175
<b>Protective devices</b>	
118G	176
<b>Warning notices</b>	
118H	176
<b>Part 10</b>	<b>Measures to be taken for securing the health of persons in building work, excavation work and compressed air work by provision of first-aid equipment, shelter, change and dining accommodation, sanitary conveniences and washing facilities</b>
<b>Division 10.1</b>	<b>First-aid equipment</b>
119	178
<b>Division 10.2</b>	<b>Shelter, change and dining accommodation</b>
120	185

		Contents
		Page
<b>Division 10.3</b>	<b>Sanitary conveniences and washing facilities</b>	
121		188
<b>Part 11</b>	<b>Basic requirements about design and construction, erection, use, maintenance, inspection and testing with particular reference to cranes, lifts, hoists, scaffolding and plant</b>	
122		191
<b>Wind loads</b>		
123		203
<b>Horizontal forces (other than those due to wind)</b>		
124		207
<b>Dynamic and repealed loadings</b>		
125		208
<b>Maximum permissible stresses</b>		
126		209
<b>General</b>		
127		233
<b>Stability</b>		
128		267
<b>Test loads</b>		
129		271
<b>Mechanical</b>		
130		272
<b>Materials</b>		
131		292
<b>Fencing—general</b>		
132		295
<b>Jointers</b>		
132A		297
<b>Electrical</b>		
133		298

---

R4	Scaffolding and Lifts Regulation 1950	contents 9
12/04/07	Effective: 12/04/07-30/09/09	

	Page
<b>Stiff-leg derrick cranes</b>	
134	305
<b>Caterpillar cranes and mobile cranes</b>	
135	308
<b>Gravity operated overwinding limit devices</b>	
<b>Electrical</b>	
136	309
<b>Fork-lift trucks</b>	
137	312
<b>Commercial type hoists</b>	
138	314
<b>Tower hoists for constructional, building, demolition, or excavation works</b>	
139	316
<b>Whip or sheerleg hoists for constructional, building, demolition, or excavation works</b>	
140	324
<b>Part 12</b>	<b>Plant and gear</b>
<b>General</b>	
141	327
<b>Ladders</b>	
<b>Definitions</b>	
142	327
<b>Chain for use in connection with cranes, lifts, hoists, scaffolding, plant, gear, or building work, excavation work, or compressed air work</b>	
143	347
<b>Steel wire ropes for use in connection with cranes, lifts, hoists, scaffolding, plant, gear, or building work, excavation work, or compressed air work</b>	
144	360

	Page
<b>Fibre rope for use in connection with cranes, lifts, hoists, scaffolding, plant, gear, or building work, excavation work, or compressed air work</b>	
145	399
<b>Airlocks</b>	
146	403
<b>Bordeaux connections</b>	
147	403
<b>Sockets for wire ropes</b>	
148	403
<b>Thimbles for wire and fibre rope</b>	
149	403
<b>Steel eye bolts</b>	
150	404
<b>Mild steel rigging screws, and stretching screws and turnbuckles</b>	
151	404
<b>Mild steel shackles</b>	
152	404
<b>Rings, links alternative to rings, egg links and Intermediate links</b>	
153	405
<b>Handrails</b>	
154	405
<b>Rope clips</b>	
155	406
<b>Gin blocks used with fibre rope</b>	
156	406
<b>Lift boxes</b>	
157	407

		Page
<b>Part 13</b>	<b>Precautions and measures to be taken for securing the safety of persons in connection with roofs sheathed with asbestos cement or other brittle material</b>	
158		408
<b>Part 16</b>	<b>Miscellaneous and penalties</b>	
<b>General penalty</b>		
164		417
<b>Schedule 3</b>	<b>Method of treatment of silica paint for the purpose of ascertaining the percentage of free silica present</b>	418
<b>Schedule 4</b>	<b>Processes to which s 73 (1) (o) applies</b>	419
<b>Schedule 5</b>	<b>Method of treatment of a lead compound for the purpose of determining the percentage of dry compound of lead</b>	420
<b>Schedule 7</b>		421
<b>Schedule 8</b>	<b>Medical standards and examination report for compressed air workers</b>	455
<b>Schedule 9</b>	<b>Symptoms and treatment of compressed air illness</b>	458
<b>Dictionary</b>		460

		Page
<b>Endnotes</b>		
1	About the endnotes	466
2	Abbreviation key	466
3	Legislation history	467
4	Amendment history	471
5	Earlier republications	482







Australian Capital Territory

# Scaffolding and Lifts Regulation 1950

---

made under the

**Scaffolding and Lifts Act 1912**

---

## Part 1 Preliminary

### 1 Name of regulation

This regulation is the *Scaffolding and Lifts Regulation 1950*.

### 2 Dictionary

The dictionary at the end of this regulation is part of this regulation.

*Note 1* The dictionary at the end of this regulation defines certain terms used in this regulation, and includes references (*signpost definitions*) to other terms defined elsewhere in this regulation.

For example, the signpost definition '*cantilever scaffolding*—see section 85.' means that the term 'cantilever scaffolding' is defined in that section.

*Note 2* A definition in the dictionary (including a signpost definition) applies to the entire regulation unless the definition, or another provision of the regulation, provides otherwise or the contrary intention otherwise appears (see Legislation Act, s 155 and s 156 (1)).

### 3 Notes

A note included in this regulation is explanatory and is not part of this regulation.

*Note* See the Legislation Act, s 127 (1), (4) and (5) for the legal status of notes.

### 4 Plates, figures and sketches

Any plates, figures or sketches shown in this regulation and to which reference is made in the text should not be construed as specifications but should be considered as types for information or guidance only in construction.

### 5

If the chief inspector is satisfied that for any particular class or description of crane, lift, hoist, scaffolding, plant or gear, or roof sheathed or intended to be sheathed with asbestos cement or other brittle material or of any special description or method of building

work, excavation work, or compressed air work, the application of any requirement of this regulation relating to safety or health is, in any class or description of circumstances, not necessary in the interests of safety or health or is not reasonably practicable, the chief inspector may by written certificate (which the chief inspector may at the chief inspector's discretion revoke at any time) grant an exemption from that requirement for that class or description of crane, lift, hoist, scaffolding, plant or gear, or roof sheathed with asbestos cement or other brittle material or of that special description or method of building work, excavation work or compressed air work in the circumstances and subject to the conditions that may be specified in the certificate.

**6**

- (1) If the obligation to observe any of the provisions of this regulation is not by this regulation specifically imposed on any person it is the obligation of every person who directly or by his or her servants or agents—
  - (a) carries out any building work, excavation work or compressed air work; or
  - (b) designs, constructs, erects, sets up or builds, or sets or places in position, works, uses, tests or maintains any crane, lift, hoist, scaffolding, plant or gear, or roof sheathed or intended to be sheathed with asbestos cement or other brittle material;to comply with the provisions of this regulation.
- (2) A person must not directly or by his or her servants or agents use any crane, lift, hoist, scaffolding, plant or gear, unless it has been classified, designed, constructed, erected, set up, built or set or placed in position, and installed, and unless the person uses and maintains it, in accordance with the provisions of this regulation.

**7**

Every person must use the safeguards given and provided in accordance with this regulation and a person must not interfere detrimentally in any way with the use of the safeguards by any other person, nor with the use of any safeguard method or process.

## Part 2                      **Qualifications, powers and duties of the chief inspector and inspectors**

### 11

A person must not falsely pretend to be an inspector.

### 13

An inspector has the power to—

- (a) conduct prosecutions whether the information is laid in the inspector's name or not; and
- (b) attend and examine witnesses at any inquest into the cause of the death of any person following on an accident arising from the construction, erection, setting up or building or setting or placing in position, installation, alteration, working or use of any crane, gear, hoist, lift, plant, scaffolding or part of it, or occurring in relation to any building work, excavation work or compressed air work or any roof sheathed with asbestos cement or other brittle material; and
- (c) direct the owner of, or person in charge or apparently in charge of any crane, lift, hoist, scaffolding, plant or gear, or the contractor or person in charge or apparently in charge of any building work, excavation work or compressed air work, to take the measures and provide the equipment and assistance that the inspector may require to facilitate any inspection, and the person must forthwith carry out the directions.

**14**

An inspector may require the production of any certificate or permit that by the Act or this regulation is required to be held by any person or require the production of any notice, record or document that is by the Act or by this regulation required to be kept or exhibited and to inspect, examine and copy it.

## **Part 4**                      **Lifts**

### **Division 4.1**            **Interpretation**

#### **16**

- (1) In this part:

*conveyor* means a lift so arranged that goods are raised or lowered by means of an endless belt or chain or by fittings attached to the lift, in an inclined or vertical direction.

*safety gear* means a mechanical device or mechanism attached to the underside of a lift car that on operation will stop and sustain the car independently of the lifting ropes.

*service lift* means a lift the car of which has a floor area of not more than 9 square feet and a height of not more than 4 feet, used to carry goods only, and controlled from without the lift-well, and also includes any lift certified by the chief inspector to be a service lift.

#### *S.A.A. Lift Code*

- (2) The provisions of Code No C.A. 3—1947 published by Standards Australia entitled ‘Australian Standard Rules for the Design, Installation, Testing and Operation of Lifts and Escalators’ apply to any matter or thing not provided for in this regulation.

### **Division 4.2**            **Design, construction and erection of lifts**

#### **Permit to erect or alter lifts**

#### **17**

- (1) No person shall erect or alter a lift without first obtaining a permit from the chief inspector.

- (2) The applicant for a permit to erect a lift shall lodge with the chief inspector a description and plans of the lift that includes particulars of the machine, control, operating and safety devices, size and construction of car, and a general layout showing the size of the motor room and means of access to it, supports for the machine and guides, the overruns, the pit and the lift-well enclosures, and shall specify the maximum load that the lift is designed to carry and the rated speed of the lift.
- (3) The applicant for a permit to alter a lift shall lodge a description and particulars of the proposed alterations.
- (4) The description and plans shall be filed in the office of the chief inspector.
- (5) Before granting a permit the chief inspector may require any alterations in the design to be made that appear to the chief inspector to be necessary for the safe working of the lift or to ensure compliance with this regulation.
- (6) Every lift shall be erected in accordance with the description and plans submitted to and approved by the chief inspector and in accordance with any direction endorsed on the permit and in conformity with this regulation.

### **Safe working load of a lift**

#### **18**

- (1) The safe working load specified in the permit to erect or alter a lift shall be the safe working load of the lift.
- (2) The chief inspector may by written notice served on the owner vary the safe working load of any lift and the safe working load as varied shall then be the safe working load of the lift until revoked or further varied by the chief inspector.



- (3) The notice stating the safe working load required to be exhibited under section 70 may state a safe working load less than the safe working load as determined under this section.
- (4) The notice stating the safe working load required to be exhibited in the car of a passenger lift shall state the maximum number of people to be carried, which number shall not be greater than the safe working load in pounds divided by 150.
- (5) The notice stating the safe working load required to be exhibited in relation to lifts other than passenger lifts must state the load in pounds.

## **Construction**

### **19**

Every lift and every part of it shall be of sound material, good construction, adequate strength, free from patent defects and be suitable and safe for the purpose for which it is intended.

### **20**

All work performed and all machines, equipment and material used in connection with any lift shall be subject to the approval of the chief inspector, who shall, as often as it appears to the chief inspector necessary, cause them to be inspected and tested.

### **21**

No person other than a person engaged on the erection, or alteration of a lift, shall work, use or interfere with the lift until the lift has been approved by an inspector for general use.

## **Car loading automatic passenger lifts**

### **22**

- (1) Every passenger lift being an automatic lift shall be designed and constructed on the basis of a load of not less than 75 pounds per square foot of net car or platform floor area.
- (2) The chief inspector may exempt from the operation of this section any lift designed to carry beds, stretchers or invalid chairs in a hospital or similar institution, or any lift with a car floor area not exceeding 9 square feet.

## **Supporting structures and machine rooms**

### **23**

- (1) The supporting structure of every lift shall be designed and constructed in accordance with part 11.
- (2) The machine, control mechanism and all parts of the equipment of every lift, other than those parts that must necessarily be placed elsewhere to effectively perform their functions shall be housed in a machine room.
- (3) The area and height of the machine room shall be adequate to permit of free and safe access for purposes of inspection and maintenance of all parts of the machine and lift equipment located in it, and the machine room shall be adequately illuminated and ventilated and shall be provided with safe and convenient means of access.
- (4) Every entrance to the machine room shall be provided with a door.
- (5) Every door to the machine room shall be provided with a lock that can be opened from outside the room only by the use of a key.
- (6) If the door locks on closing, it shall be of a type that does not require a key to unlock it from within the machine room.

- (7) If lift machine room equipment is situated on more than 1 floor, effective means of switching off the power shall be provided at each floor.

## Overruns

### 24

- (1) The overrun provided for a car and for a counterweight of any lift other than for a service lift, shall be not less than that specified in table 24:

Table 24

rated speed in feet per/min	Car		Counterweight			
	top overrun		bottom overrun		top overrun (with car landed)	
	traction drive	drum drive	traction drive	drum drive	traction drive	drum drive
	ft. in.	ft. in.	ft. in.	ft. in.	ft. in.	ft. in.
0 to 100	3 0	4 0	1 6	1 6	1 6	3 0
101 to 200	3 0	4 0	2 0	2 0	1 6	3 0
201 to 300	4 0	5 4	2 6	2 6	2 0	4 0
301 to 400	5 0	..	3 0	..	2 6	..
401 to 500	6 0	..	3 6	..	3 0	..
501 to 600	7 0	..	4 0	..	3 6	..

- (2) The top and bottom overrun for the car and the counterweight of any service lift shall be that specified in table 24 except that the bottom overrun of a car shall be 12 inches.
- (3) The bottom overrun for the counterweight of a traction-drive lift when the car floor is level with the top landing shall not be greater than  $\frac{1}{2}$  of the top overrun provided for the car.
- (4) The final limit gear of the lift shall operate before the counterweight lands.

- (5) The bottom overrun for the counterweight of a drum-drive lift when the car floor is level with the top landing shall not be greater than  $\frac{1}{4}$  of the top overrun provided for the lift car.
- (6) The final limit gear of the lift shall operate before the counterweight lands.

## Stops and buffers

### 25

- (1) Approved stops or buffers of the type prescribed table 25 as appropriate to the running speed of the lift car or counterweight shall be provided for the car and counterweight of all lifts other than service lifts.

**Table 25**

running speed of car or counterweight	type of stop or buffer
not exceeding 100 feet/min	solid stops, spring buffers, oil buffers or impact-absorbing stops
exceeding 100 feet/min, but not exceeding 200 feet/min	spring buffers or oil buffers
exceeding 200 feet/min	oil buffers

- (2) Buffers so provided shall comply with the following requirements:
  - (a) *spring buffers*—springs for buffers shall be so designed that they will not take a permanent set on absorbing the energy of the fully loaded car at governor-operating speed; and
  - (b) *oil buffers*—the minimum total stroke of oil buffers shall be based on an average retardation of 32.2 feet per second per second, based on the governor-operating speed, and the maximum retardation based on the governor-operating speed shall not be in excess of 80.5 feet per second per second ( $2\frac{1}{2}$  times gravity retardation).

- (3) Effective means shall be provided for readily ascertaining the adequacy of the oil supply.
- (4) Provision shall be made, by fitting a spring or by other suitable means, for taking the initial impact between the car or counterweight and the buffer.

### **Permanent stops**

#### **26**

The final obstruction at the top and bottom of every lift-well shall ensure that in the event of an overwind the car and counterweight will remain in their guides with the car floor and the horizontal faces of the counterweight level.

### **Pits**

#### **27**

- (1) The wells of all lifts shall continue to solid earth except in the circumstances and subject to the conditions that the chief inspector may approve.
- (2) The pits of all lifts shall be constructed to remain dry and shall be provided with safe and convenient means of access.
- (3) Suitable means of access and lighting to permit of safe and efficient maintenance of safety gear shall be provided.
- (4) The pits of all lifts other than service lifts shall be of sufficient depth to provide the overrun specified in section 24 and in addition a clearance of not less than 24 inches between the underside of the car platform and the floor of the pit when the car is landed with the buffers fully compressed.

## Enclosures

### 28

- (1) All liftwells shall be completely enclosed from the bottom of the pit to the underside of the overhead supporting beams with approved material of adequate strength.
- (2) All windows in lift-well enclosures shall be closed and fixed.
- (3) All windows and openings accessible from fire-escapes, stairways, platforms, adjacent roofs and those on ground floors and basement levels as well as any window up to a height of 20 feet and opening on to a public place, cartway or yard or similar area shall be barred or otherwise permanently protected.

## Enclosure doors

### 29

- (1) Every enclosure door of every automatic lift other than a service lift shall be provided with 2 separate electromechanical interlocks each arranged to electrically and mechanically interlock the enclosure door with the control of the lift.
- (2) If latches are used they shall be of a design that will prevent fingers projecting through the latch hole and the latch shall be clear of the door surrounds when the door is fully open.
- (3) These electromechanical interlocks shall ensure that—
  - (a) the car cannot move or continue in motion unless every enclosure door is closed and locked.
- (4) For subsection (3) (a), an enclosure door may be considered locked if complete locking occurs within the period that the car takes to move 9 inches from the landing on which the enclosure door is situated.
- (5) Each enclosure door may only be unlocked and opened when the car is stationary and its floor is level with the landing or within 9 inches

of it at which the enclosure door is situated or the car is within the control of the levelling device at that landing.

- (6) Every enclosure door of every lift other than an automatic lift shall be provided with an electromechanical interlock that shall ensure that the car cannot move or continue in motion unless every enclosure door is closed and locked and that the enclosure door can only be unlocked from the car.
- (7) Every enclosure door of every service lift shall be interlocked with the control so that the car cannot move or continue in motion unless every enclosure door is closed and locked and so that the enclosure doors can only be opened when the car floor is level with the landing or within 9 inches of the landing on which the enclosure door is situated.
- (8) For this section, an enclosure door may be considered locked if complete locking occurs within the period that the car takes to move 9 inches from the landing on which the enclosure door is situated.
- (9) Except for a lift fitted with both power-operated doors and a position-indicating device, every enclosure door of an automatic lift shall be provided with a panel, not less than 1 square foot in area, through which the car may be clearly seen from the landings.

## **Clearance in wells**

### **30**

- (1) Adequate clearances shall be provided for the car and counterweight in every lift-well.
- (2) Piping, conduit, or other equipment not forming part of the lift installation shall not be installed in a lift-well, except with the approval of the chief inspector.

## Ropes and sheaves

### 31

- (1) Flexible steel or iron wire ropes shall be used for the lifting, governor and compensating ropes of all lifts, and the ropes shall not be spliced for purposes of repair or extension.
- (2) Chains shall not be used for suspending cars or counterweights of lifts.
- (3) The minimum number of lifting ropes for cars and counterweights of lifts, other than service lifts, shall be 2 for drum-drive lifts and hydraulic lifts and 3 for all other types.
- (4) The factor of safety for lifting ropes shall not be less than 10.
- (5) The minimum diameter of suspension ropes for cars and counterweights shall be  $\frac{3}{8}$  of an inch except for service lifts where the minimum diameter shall be  $\frac{1}{4}$  of an inch.
- (6) The ratio of the diameter of any drum or sheave to the diameter of the rope used on it shall be not less than—
  - (a) 45:1 for passenger or goods lifts; and
  - (b) 40:1 for service lifts; and
  - (c) 38:1 for compensating ropes; and
  - (d) 25:1 for governor ropes.
- (7) All drums and sheaves shall be grooved to correctly embrace the ropes, and to prevent any overriding or jamming.
- (8) Lifting ropes shall be effectively anchored to drums and not less than  $1\frac{1}{2}$  turns of each rope shall remain on a drum when the lift car or counterweight has landed.
- (9) If compensating ropes are used, provisions shall be made for automatically stopping the lift in the event of the compensating sheave rising or falling beyond predetermined limits.



- (10) If 2:1 roping is used provision shall be made to prevent the ropes leaving their correct grooves, and the sheaves on the car shall be effectively guarded and a convenient handhold provided.

## **Lift cars**

### **32**

- (1) Steel shall be used for the bow, side members, safety gear bearers and platform frames for the car of every lift, other than a service lift.
- (2) The bow of every service lift shall be strapped to the car floor with steel.
- (3) Every passenger lift car shall have a roof that covers the whole area of the car, and the cars of goods lifts shall have a roof when so directed by an inspector.
- (4) The roof of every lift car shall be constructed to provide a sound, flat surface of as large an area as practicable and affording a firm foothold, and shall be of adequate strength to support safely the weight of the workers that might go on it and any equipment required to be placed on it.
- (5) Glass shall not be used in car roofs.
- (6) The roof of every lift car other than a service lift shall be provided with a hinged panel, capable, if necessary, of being raised from inside or outside the car and when partly or fully opened shall not foul any enclosure or fitting in the lift-well.
- (7) The panel opening to be of such size as to permit the easy ingress or egress of a man.
- (8) The hinged panels on automatic lifts shall be electrically and mechanically interlocked with the control of the lift.
- (9) The roof of every service lift car shall be set back not less than 6 inches from the line of the car floor nosing, or for such distance the roof shall be in the form of a hinged flap capable of lifting.

- (10) The sides of every lift car shall extend from the car floor to the car roof.
- (11) If a roof is not provided to the car of a goods lift, the sides shall be of the height that an inspector may direct but shall not be less than 6 feet in height, and adjacent to the counterweight shall not be less than the height of the car bow.
- (12) Plain glass shall not be used in lift cars other than for covering notices and indicators.
- (13) Lamps and lamp fittings shall be of adequate strength and security to withstand the operation of the safety gear without damage.

## **Car gates**

### **33**

- (1) A gate or door affording adequate protection and electrically interlocked with the control shall be provided across every car entrance of—
  - (a) every automatic lift other than a service lift; and
  - (b) every passenger lift other than an automatic lift, except that a gate or door need not be provided at 1 entrance of the car of a passenger lift, if the control is adjacent to it so that the attendant can conveniently extend his or her arm across the entrance and the width of the entrance does not exceed 42 inches and the whole face of the well including the enclosures adjacent to the car entrance is flush and not more than 1<sup>1</sup>/<sub>2</sub> inches from the car floor nosing; and
  - (c) every goods lift other than an automatic lift, except that a gate or door need not be provided at 1 entrance of the car of a goods lift, if the control is adjacent to it and the whole face of the well including the enclosures adjacent to that car entrance is within 3<sup>1</sup>/<sub>4</sub> inches of the car floor nosing.

- (2) Any offsets in the face of an enclosure mentioned in subsection (1) (c) shall be bevelled on the underside at not less than 3 inches vertical to 1 inch horizontal.
- (3) All power driven car gates or doors shall be so constructed as to be capable of being opened manually.
- (4) The electric interlock of the car gates of every automatic lift shall be placed in a position inaccessible to a person standing on the car floor.
- (5) If levelling devices are used the car floor shall be provided with a substantial toe-guard flush with its outer edge extending a sufficient distance below the car floor so that there shall be no opening into the lift-well while the car is within the levelling zone.

### **Lighting and ventilation of cars**

#### **34**

The car of every lift other than a service lift shall be provided with—

- (a) adequate ventilation; and
- (b) effective means for interior electrical illumination; and
- (c) facilities on the car roof for attaching an electric light if an inspector so directs; and
- (d) unless other provision is made for illuminating the pit of the lift, an electric light on the underside of the car.

### **Safety gear**

#### **35**

- (1) The car of every suspended lift other than a service lift shall be provided with effective safety gear.
- (2) A speed governor operating the safety gear shall be provided if the travel of the lift car exceeds 30 feet and on lifts erected after 19 September 1957 if the travel exceeds 18 feet.

- (3) The safety gear shall be of a type that brings the car to an easy and gradual stop when the rated speed of the lift exceeds 200 feet per minute.
- (4) Instantaneous safety gear operating on timber backings for guides may only be used on lifts the rated speed of which does not exceed 200 feet per minute, or if operating on steel guides may be used on lifts the rated speed of which does not exceed 125 feet per minute.
- (5) Speed governors shall be constructed, adjusted and maintained as to cause the operation of the safety gear at or before the speeds specified in table 35.

**Table 35**

<b>rated speed of lift feet/min</b>	<b>maximum operating speed of governor feet/min or % of rated speed</b>
up to 100	140 feet/min
from 100 to 500	40% in excess of rated speed
over 500	200 feet/min in excess of rated speed

- (6) Speed governors of electric lifts whose speed exceeds 200 feet per minute shall have a switch that shall open before or at the time the governor grips the governor rope, and shall open the motor and brake circuits and stop the machine.

## **Machines**

### **36**

- (1) All lift machines other than hydraulic shall be provided with efficient brake gear.
- (2) Traction sheaves, except for service lifts, shall not be overhung.
- (3) Worms and their shafts shall be constructed in a single piece.

- (4) No drum-drive lift shall have a speed greater than 300 feet per minute.

## **Counterweight**

### **37**

- (1) The top 15 feet of the counterweight guides of all drum-drive machines, except for service lifts, shall be enclosed by a substantial and firmly secured screen.
- (2) If a counterweight, other than the one balancing the car travels adjacent to that car, then the path of travel of this counterweight shall be screened from that car.

## **Guides**

### **38**

- (1) The car and counterweight of every lift shall run between guides of adequate section and so supported as to withstand the loads from guide shoes and the operation of the safety gear without undue deflection.
- (2) Car and counterweight guides shall be of steel except for service lifts and for lifts operating at a speed not exceeding 100 feet per minute.

## **Electrical equipment**

### **39**

- (1) All electrical conductors, appliances and equipment used in connection with every lift shall be of sufficient size and so constructed, installed, protected and maintained as to be safe for, and in use.
- (2) If more specific provision is not made elsewhere in this regulation, they shall conform with the provisions of the S.A.A. Wiring Rules.

- (3) All electrical wiring in every lift-well, and on every lift car, other than flexible conductors, shall be in screwed conduit.
- (4) The electric controlling gear of every lift must operate without causing excessive strain in any part of the apparatus, and shall automatically slow down the car and cut off the control current at both limits of travel, and shall ensure that acceleration in starting and deceleration in stopping is not excessive.
- (5) The control circuits of all lifts shall not exceed 250V and 1 side of the circuits shall be at earth potential.
- (6) The metal frames and covers of all motors, interlocks and electrical equipment and conduit of every lift shall be effectively earthed.

## **Car switch**

### **40**

- (1) The switch used in a lift car for normal operation of the lift shall automatically return to the 'stop' position on the removal of the operator's hand, and provision shall be made for the securing of the switch handle in the 'stop' position.
- (2) If the switch in centring does not immediately stop the lift, an emergency switch shall be provided for this purpose and car gates extending the full width of the car openings shall be provided.

## **Limit gear**

### **41**

- (1) Every lift shall be provided with limit gear that will automatically stop the machine before the car or counterweight lands.
- (2) Drum-drive machines shall be provided with limit gear integral with the machine and limit gear operated by the movement of the car.
- (3) Electric lifts other than traction-drive service lifts shall be provided with 2 separate and independent limit gears, 1 of which shall open the

control circuit and the other shall completely cut off all electrical pressure from the motor, control and brake.

- (4) Every electric service lift, other than a drum-drive service lift, fitted with a thermal overload switch shall be provided with a time switch set to stop the machine at not greater than twice the interval of time normally taken for the car to run its full length of travel.
- (5) The time switch shall be of the normal reset type.

### **Slack cable device**

#### **42**

Every drum-drive lift, other than a service lift, shall have a device that will automatically stop the machine should the car lifting ropes become slack from any cause whatsoever.

### **Safety gear switch**

#### **43**

All automatic lifts shall be provided with a device that will cut off the current and stop the machine in the event of the safety gear operating.

### **Stop button**

#### **44**

Automatic lifts, other than service lifts, shall be provided with an emergency stop button clearly marked as such and placed in close proximity to the control buttons in the car.

## Signal call system

### 45

Every lift, other than an automatic lift, shall have a signal call and indicator in the car that can be operated from each floor except for lifts where response to a call is an automatic function.

## Hydraulic equipment

### 46

- (1) Only piping, fittings and gear made specially for hydraulic pressures shall be used on hydraulic lifts.
- (2) The whole of the machinery, gear and piping subject to hydraulic pressure shall be tested to twice the working pressure in the presence of an inspector after the erection of every lift and before it is used.
- (3) A similar test shall be conducted in relation to any part of machinery, gear and pipes subject to hydraulic pressure on re-erection, reinstatement or renewal.
- (4) Rams of all hydraulic lifts shall be provided with permanent stops that will prevent them being forced out of their cylinders.
- (5) Every hydraulic lift shall be provided with a control valve, a screw down pressure stop valve, a non-return valve, and a tee piece for testing purposes.
- (6) The non-return valve shall be as close as practicable to the control valve and the tee piece shall be between the non-return valve and the point of entry of the service.
- (7) The control valve of every hydraulic lift shall automatically cut off the power at both limits of travel of the car before the car lands or the ram reaches its permanent stop and also in the event of the breakage of the control rope.



- (8) The construction of the valve must preclude the possibility of the valve spindle blowing out should it become parted and both ends of the control rope shall be connected to the control valve mechanism.
- (9) An air cock shall be fitted at the top of the hydraulic cylinder of every hydraulic lift and provision made to prevent the syphoning of water from the cylinders.
- (10) The rams of every direct-acting hydraulic lift shall be positively attached to the car, such attachment to have sufficient working clearance.
- (11) Provision shall be made to permit of the safe and efficient maintenance of all machinery and control mechanism of every hydraulic lift.

## **Escalators**

### **47**

Every escalator and every part of it shall be of sound material, good construction, adequate strength, free from patent defects and be suitable and safe for the purpose for which it is intended.

## **Trusses or girders**

### **48**

Every truss or girder shall be capable of safely keeping the steps and running gear in the event of failure of the track system to keep the running gear in its guides.

## **Track arrangement**

### **49**

The track arrangement of all escalators shall be so designed as to prevent displacement of the treads and running gear in the event of a tread chain breaking.

## **Angle of inclination**

### **50**

The angle of inclination of every escalator shall not exceed 30° from the horizontal.

## **Balustrading**

### **51**

- (1) Every escalator shall be provided on each side with a solid balustrade.
- (2) On the escalator side the balustrade shall be smooth without depressed or raised panelling save that flush panels may be separated by metal mouldings of a thickness of not more than  $\frac{1}{8}$  of an inch and having bevelled edges.
- (3) Glass shall not be used on the inside of any balustrade.
- (4) Every balustrade shall be provided with a continuous handrail without open joints moving at the same speed and in the same direction as the treads.

## **Treads and landings**

### **52**

The treads and landings of every escalator shall be of a material that will afford a secure foothold.

## **Power unit**

### **53**

An electric motor shall not be used to drive 2 or more escalators unless the escalators are situated side by side and are operated as a single unit.

## **Chains**

### **54**

All chains of every escalator shall have a factor of safety of not less than 10, except if the chain is composed of cast steel links which shall be thoroughly annealed, in which case the factor of safety shall be not less than 20.

## **Automatic brakes**

### **55**

Every escalator shall be provided with an electrically released mechanically applied brake that shall stop the escalator automatically when the power supply is cut off.

## **Starting switch and stop button**

### **56**

- (1) The starting of every escalator shall be by means of a key operated switch or a switch inaccessible to the public.
- (2) A button for stopping the escalator shall be placed accessible to the public at the top and bottom landings of every escalator.
- (3) The buttons shall be permanently and prominently marked 'Stop Button'.
- (4) The release or pressing of a stop button must not start the escalator.

## **Safety devices**

### **57**

Every escalator shall be equipped with safety devices that will cause the power to be cut off—

- (a) in the event of the breaking of any tread chain; or

- (b) whenever the speed of the escalator exceeds the rated speed by 20%; or
- (c) in the event of the accidental reversal of the escalator when it is set to operate in the ascending direction.

### **Reverse phase relay**

#### **58**

Every escalator operated by a polyphase electric motor shall be provided with a device that will prevent the motor being started while the phase rotation is in the wrong direction or while there exists a failure of any phase.

### **Machine room**

#### **59**

The machine room of every escalator shall be of such size as will permit of the safe and efficient maintenance of all parts of the machinery and other equipment located in it, and the machine room shall be adequately lighted and shall be provided with safe means of access.

### **Construction of conveyors**

#### **60**

Every conveyor and every part of it shall be of sound material, good construction, adequate strength, free from patent defects and be suitable and safe for the purpose for which it is intended to be used.

## **Electrical installation**

### **61**

- (1) All electrical conductors, appliances and equipment used in connection with every conveyor shall be of sufficient size and so constructed, installed, protected and maintained as to be safe for, and in use.
- (2) If more specific provision is not made elsewhere in this regulation, they shall conform with the provisions of the S.A.A. Wiring Rules.

## **Control**

### **62**

- (1) Provision shall be made on every conveyor—
  - (a) to ensure that the conveyor will stop when the driving power is cut off and remain stopped until the power is restored; and
  - (b) to permit the conveyor being stopped at each point of loading or delivery; and
  - (c) to prevent the conveyor being restarted from any point until the device by which it was stopped has been reset in the running position.
- (2) Any push button used for stopping the conveyor must be capable of being secured in the stop position.

## **Enclosures**

### **63**

- (1) Every conveyor shall be adequately enclosed and guarded.
- (2) The enclosing and guarding shall be to the satisfaction of the inspector.

## **Provision for maintenance**

### **64**

Provision shall be made to permit of the safe and efficient maintenance of all machinery and control mechanism of every conveyor.

## **No persons permitted to travel**

### **65**

No person shall travel or be permitted to travel on a conveyor.

## **Load notice**

### **66**

A safe working load notice shall be exhibited at each point of loading of every conveyor.

## **Division 4.3 Maintenance of lifts**

### **67**

- (1) Every lift and all parts of it shall be maintained in conformity with this regulation and in safe and proper working condition, and in accordance with the following provisions:
  - (a) all motor rooms, wells and pits shall be kept clean and free from accumulation of rubbish, dirt, dust or impedimenta;
  - (b) pits shall be kept dry;
  - (c) all guides, safety gear, machinery and equipment shall be kept lubricated, and machines and equipment shall be kept clean and free from accumulation of dust and dirt;

- (d) all ropes showing indications of excessive wear, splintering, stranding, bunching or rust shall at once be replaced by new ropes;
  - (e) ropes liable to rust shall be treated with a suitable lubricant or a rust preventive compound;
  - (f) all enclosures shall be maintained in a safe and effective condition;
  - (g) all enclosure doors shall be maintained in proper working condition, and so that they cannot leave their tracks or guides;
  - (h) the enclosure door interlocks shall be maintained in conformity with section 29;
  - (i) all safety gear shall be kept in effective working condition;
  - (j) all limit gear, and other safety devices shall be maintained in proper working condition and correct adjustment;
  - (k) the rams of all hydraulic lifts shall be kept in such condition that there shall be no leakage at the gland, and this without unduly pinching the ram;
  - (l) the controlling mechanism of all hydraulic lifts shall be maintained in such condition that—
    - (i) the lift will automatically stop before the car lands or the ram reaches its permanent stop; and
    - (ii) the lift will stop in the event of breakage of the control rope, and
    - (iii) creeping will not occur when the valve is in the ‘stop’ position.
- (2) It shall be the duty of the owner of a lift to observe the provisions of this section.

## **Division 4.4 Use of lifts**

### **68**

- (1) No person shall operate any lift by manipulation of the enclosure door interlocks or car gate interlocks or of the control mechanism in the machine room.
- (2) No person shall operate any rope control lift, other than a service lift, from any landing or any place other than the car.
- (3) No person shall load any lift in excess of its safe working load.
- (4) No person in charge of any lift shall—
  - (a) load or permit the lift to be loaded in excess of the safe working load; or
  - (b) move the car from any landing unless all the enclosure doors are closed and locked and the car gates are closed; or
  - (c) permit the car to be loaded or unloaded or take in or let out passengers unless the car is at rest, the power shut off and the car switch is secure in the stop position; or
  - (d) for a rope controlled lift—leave the car unless the rope is locked in the stop position.
- (5) This section shall not apply to any bona fide worker engaged in erecting, repairing, inspecting or testing a lift, or to an inspector.

## **Change of ownership**

### **69**

If the ownership of any lift has been changed, the new owner shall, within 7 days of the change give notice of the change to the chief inspector.



## 70

There shall be placed and kept in the car of every lift other than a service lift—

- (a) a legible notice stating—
- (i) the safe working load of the lift; and
  - (ii) for a goods lift—the names of the persons specifically empowered by the owner to work or operate the lift; and
  - (iii) the name, address and telephone number of the company or person maintaining the lift or engaged to attend the lift in case of stoppage or accident; and
  - (iv) for multi-tenanted buildings without resident caretakers— if the inspector so directs, the name and address of the owner of the lift; and

- (b) a copy of section 68 and section 69 and a statement as follows:

Section 18 of the Act requires accidents to be notified to the chief inspector by the owner or person in charge of a lift, and prohibits the use of a lift after an accident without permission of an inspector.

For the purposes of the Act, *owner* of a lift includes the owner, mortgagee in possession, lessee, hirer or borrower thereof.

## 71

There shall be placed and kept beside the control at the principal landing and the other landings that the inspector may direct of every service lift a copy of section 68 (1) and (3) and a notice stating the safe working load of the lift.

## 72

The owner of a lift shall be responsible for the observance of the provisions of section 70 and section 71.

## **Part 5 Safeguards and measures to be taken for securing the safety and health of persons engaged in building work**

### **Division 5.1 General**

#### **73**

- (1) Any person who directly or by his or her servants or agents (including every independent contractor from time to time engaged in that work) carries out any building work shall take all measures that appear necessary or advisable to minimise accident risk and to prevent injury to the health of persons engaged in the building work and for this purpose, without limiting the generality of the foregoing, the person shall—
- (a) provide suitable and safe scaffolding, which shall conform to the requirements of this regulation, for all work that cannot be done safely by a person standing on permanent or solid construction, except when the work can be done safely from ladders constructed in conformity with the provisions of this regulation; and
  - (b) provide and maintain safe means of access to every place where any person has to work at any time; and
  - (c) provide means by fencing or otherwise for securing the safety of any person working at a place from which the person would be liable to fall a distance of more than 6 feet; and
  - (d) make provision to secure and maintain lighting (natural or artificial) sufficient and suitable for the illumination of all work places, stairways, corridors and passageways where persons must frequent, pass or use in the performance of their work or in passage to or from their work; and

- (e) whenever artificial lighting is provided—ensure that the lamps are so placed and shaded that they will not affect the safety of persons by producing glare or deep shadows and that the lamps are protected against breakage by wire guards; and
- (f) keep all stairways, corridors and passageways free from loose materials and debris, building materials, supplies and obstructions of every kind; and
- (g) where practicable provide overhead protection for persons working below other persons or where there is a likelihood of persons being injured by objects falling from above; and
- (h) ensure that the overhead protection is by means of timber or other material of strength and construction reasonably adequate to catch, deflect or hold any reasonable weight of material or objects that may fall on the protective construction; and
- (i) provide head protective helmets, of an approved type, for the use of persons working in places over which it is impracticable to fix overhead protection; and
- (j) effectively fence in the way prescribed by this regulation, all platforms, the open sides of all floors, openings in floors, roofs and platforms into which persons could accidentally walk, the open sides of stairways and stairway landings and all excavations and holes more than 5 feet deep; and
- (k) cause all working places and approaches to them to be adequately ventilated by the circulation of fresh air the ventilation to be such as to render harmless all fumes, dust or other impurities that may be injurious to health, generated or produced by any means in any such working place and approach; and
- (l) if in connection with any chipping, grinding, cleaning, spraying or manipulation of any material, there is given off any dust or fume of such a character and to such extent as to be likely to be

injurious to the health of persons employed—take all practicable measures either by securing adequate ventilation or by the provision and use of respirators (of a type approved by the chief inspector) or otherwise to prevent inhalation of the dust or fume; and

- (m) cause all exhaust gases of every engine used in an enclosed or confined space to be conducted to the open air and the place to be adequately ventilated so as to prevent danger to health from the exhaust gases; and
- (n) if any persons are employed in a process in which a lead compound or other poisonous substance is used—provide for the use of persons liable to come into contact with the compound or substance adequate and suitable facilities for washing, which shall include nail brushes, soap and towels; and
- (o) provide, where there is carried on any process specified schedule 4, the goggles of the types that are approved by the chief inspector, or effective screens to protect the eyes of persons employed on the building work; and
- (p) cause measures to be taken to ensure that scaffolding materials, tools and other objects and materials (including waste material) shall not be thrown, tipped or shot down from a height where they are liable to cause injury, but to be properly lowered, and in any place where proper lowering is not practicable and also where any part of a structure is being demolished or broken off to cause adequate steps to be taken, if necessary, to protect persons from falling or flying debris; and
- (q) cause protruding nails to be knocked in or removed from all materials used in the construction of scaffolding, false work and shuttering and take measures to ensure that no timber or material with projecting nails is allowed to remain in any place where persons are liable to come into contact with them; and

- 
- (r) take all practicable precautions by the use of adequate temporary guys, stays, supports and fixings or otherwise to prevent danger to any person through the collapse of any part of a building or structure during any temporary state of weakness or instability of the building or structure or part before the building or structure is completed; and
  - (s) if any building work is carried on that is likely to reduce, so as to endanger any person, the security or stability of any part of an existing building or structure or of a building or structure in course of construction—take all practicable precautions by shoring or otherwise to prevent danger to any person from the collapse of the building or structure or the fall of any part of it; and
  - (t) not move or permit or allow to be moved on the site of the building work any ironwork or steelwork on which there is wet paint other than paint for the purpose of jointing; and
  - (u) if on or adjacent to the site of any building work to which this regulation applies there is water into which a person employed is in the course of his or her employment liable to fall with risk of drowning—provide and keep ready for use suitable rescue equipment of an approved type and take all steps necessary for the prompt rescue of any such person in danger of drowning; and
  - (v) cause electric light and electric power installations and the electrical equipment of cranes, hoists, and plant to be installed, used and maintained in conformity with the provisions of this regulation; and
  - (w) provide adequate and suitable overhead protection to prevent persons being struck by the falling products of an electric arc or flame metal cutting process; and

- (x) provide the first-aid equipment, sanitary conveniences, washing facilities, drinking water and shelter, change and dining accommodation that are prescribed by this regulation.
- (2) However, despite subsection (1) (j) it shall be permissible to remove when necessary any guardrail, fence or part of it for the purpose of handling materials or for the installation of other work, subject to the guardrail, fence or part being at once replaced on completion of the work.
- (3) For this section:

*lead compound* means any material containing lead which, when treated in the way prescribed in schedule 5, yields to an aqueous solution of hydrochloric acid a quantity of soluble lead compound exceeding, when calculated as lead monoxide, 5% of the dry weight of the sample taken for analysis.

## 74

If the special nature or circumstances of any part of a building work render impracticable compliance with the provisions of section 73 designed to prevent the fall of any person engaged on that part of the building work, then those provisions shall be complied with so far as practicable and, except for persons for whom there is adequate hand hold and foothold, the contractor or person in charge of the building work shall provide safety nets or safety belts and life lines of a type approved by the chief inspector which will so far as practicable enable the persons to carry out work without risk of serious injury.

---

## **Fencing of floors, landings, stairways and the like**

### **75**

- (1) Wherever, by this part, it is required that a floor, platform, landing, working place, stairway or stairway landing, excavation or hold, or an opening in a floor, roof, platform or landing or that any other place shall be fenced, then the fencing shall be effected by—
  - (a) positively fastening in position uprights or posts of 4 inch by 2 inch timber at a distance of not more than 8 feet apart; and
  - (b) bolting to each upright or post mentioned in paragraph (a) the length or lengths of 4 inch by 2 inch timber that are necessary to form the top guardrail of the fence, the 4 inch by 2 inch timber being bolted at such position to each upright or post that the distance from its top edge to the level of the place being fenced is 3 feet 6 inches; and
  - (c) positively fastening to the upright or posts mentioned in paragraph (a) toe or fender boards, of not less than 9 inches by 1 inch timber, in such way that the bottom edge of each toe or fender board is level with the place being fenced and so that an opening or gap is not left between the bottom edge of the toe or fender board and the surface of the place being fenced.
- (2) Alternatively the fence may be constructed of steel members, provided that each steel member used possesses the strength and rigidity of its corresponding timber member as provided in this section.
- (3) As a further alternative the 4 inch by 2 inch guardrail may be replaced by a flexible steel wire rope, or by a fibre rope not less than 3 inches in circumference, provided that the rope is kept taut and is properly secured to the uprights or posts.

<b>Part 5</b>	Safeguards and measures to be taken for securing the safety and health of persons engaged in building work
<b>Division 5.2</b>	Constructing, erecting, adding to, altering, repairing, finishing, painting and cleaning buildings and structures

Section 77

---

## **Division 5.2                    Constructing, erecting, adding to, altering, repairing, finishing, painting and cleaning buildings and structures**

### **Stability of walls**

**77**

No wall or part of a wall shall, during its construction, be built to a greater height than 5 feet or 6 times its thickness, whichever is the greater, unless it is supported by temporary shores, proper scaffolding or buttresses at intervals of length not greater than 30 times its thickness until roof or floor ties or cross walls are in position.

### **Protection in liftwells and stairwells**

**78**

- (1) When workers are working in a lift-well or stair-well during the construction, alteration or equipping of a building, protection shall be provided not more than 2 stories above nor 1 storey below the level at which the workers are working.
- (2) The protection shall be of timber planks not less than 2 inches thick, laid across the lift-well or stair-well.

### **Temporary ramps**

**79**

- (1) A temporary ramp built to provide access for vehicles to the site of a building work shall have a grade safe for vehicles using it and shall possess adequate strength and stability under the effects of the maximum loads to which it is subjected.



- (2) The minimum width of every such ramp shall be 10 feet and a guide or kerb, at least 9 inches in height and 6 inches in width, shall be positively fixed in position at each side.

## **Provision and use of ladders and stepladders**

### **80**

#### *Definitions*

- (1) In this section:
- ladder*—see section 142.
- stepladder*—see section 142.

#### *Design and construction*

- (2) Every ladder and every stepladder used for any purpose covered by this regulation shall be designed and constructed as prescribed by this regulation.

#### *To be provided and maintained*

- (3) Any person who directly or by his or her agents or servants carries out any building work shall provide and maintain in place during working hours the ladders that are necessary to provide safe means of access to all floor levels and to all places where any person has to work until the time that temporary or permanent stairways are completed and are available as such safe means of access.

#### *Placing of ladders*

- (4) Ladders shall be placed so that—

**Part 5** Safeguards and measures to be taken for securing the safety and health of persons engaged in building work  
**Division 5.2** Constructing, erecting, adding to, altering, repairing, finishing, painting and cleaning buildings and structures

Section 80

---

- (a) each side rail or stile has a level and firm footing and the top rest for each side rail or stile is level, reasonably rigid and of adequate strength to support the maximum applied load; and
- (b) the side rails or stiles are not supported by boxes, loose bricks, or other loose packing.

*In front of doors*

- (5) A ladder shall not be placed in front of a door, opening towards the ladder, unless the door is fastened open or is locked or guarded.

*To be securely fixed*

- (6) Every ladder shall so far as practicable be securely fixed so that it cannot move either from its top or from its bottom points of rest.
- (7) If it cannot be so securely fixed it shall where practicable be securely fixed at the base or if such fixing at the base is impracticable a person shall be stationed at the base of the ladder to prevent slipping.

*In public thoroughfares*

- (8) Effective means shall be provided to prevent the displacement of a ladder set up in a public thoroughfare or in any other place where accidental collision with the ladder may occur.

*Placed against window frames*

- (9) A ladder so placed that its top end rests against a window frame shall be fitted with a board fixed to its top end the board being of such dimensions that the applied load is safely distributed over the window frame.

*Footings for stepladders*

- (10) A stepladder shall be set up on a level and firm footing and shall not be stood on loose bricks or other loose packing.

*Ladders not to support scaffolding planks*

- (11) No ladder except a trestle ladder shall be used to support a plank on which a person has to work.

*Height above landings*

- (12) Ladders used for the purposes mentioned in subsection (3) shall rise to a height of at least 3 feet 6 inches above the place of landing for persons using the ladders.

*Height when used as a working place*

- (13) A ladder used as a place from which a person has to work shall rise to a height of at least 3 feet 6 inches above the highest rung to be reached by the feet of the person working on the ladder or if that is impracticable then to the greatest practicable height.

*Landing places*

- (14) A landing place at least 27 inches in width and 48 inches in length shall be provided at the head and base of every ladder for the purposes mentioned in subsection (3) and if any person is liable to fall for a distance of more than 6 feet from it then the landing place shall be fenced in the way mentioned in section 75.
- (15) If a ladder passes through an opening in the floor of a landing place, the opening shall be as small as is reasonably practicable.
- (16) Every ladder or run of ladders rising a vertical distance of 20 feet or over shall be provided with an intermediate landing place or places

<b>Part 5</b>	Safeguards and measures to be taken for securing the safety and health of persons engaged in building work
<b>Division 5.2</b>	Constructing, erecting, adding to, altering, repairing, finishing, painting and cleaning buildings and structures

Section 80

---

so that the vertical distance between any 2 successive landing places shall not exceed 20 feet.

*Angle of ladders*

- (17) Every ladder shall, if possible, be used at such an angle that the horizontal distance from the top support to the foot of the ladder is equal to  $\frac{1}{4}$  of the length of the ladder.

*Crowding on ladders*

- (18) Persons shall not crowd together on ladders.

*Separate ladders for ascent and descent*

- (19) If, in connection with any building work, traffic conditions on ladders are such as to warrant the use of separate ladders for the purposes of ascent and descent, then such separate ladders shall be provided, designated, and used for such purposes.

*Ladders to be faced*

- (20) Persons using ladders shall face them while in the act of ascending or descending.

*Ladders not to be joined*

- (21) Ladders shall not be joined together to form a longer ladder unless a longer ladder so formed is of the strength and rigidity prescribed for ladders by this regulation.

*Single rail ladders prohibited*

- (22) Ladders made by fastening cleats across a single rail shall not be used.

*Defective ladders and stepladders*

- (23) No ladder or stepladder shall be used that has—
- (a) a missing or a weakened, broken or otherwise defective rung or tread or a broken or defective stile; or
  - (b) any rung or tread that depends for its support solely on nails, spikes, or other similar fixing.

*Prohibited uses of ladders*

- (24) A ladder shall not be used as a guy, brace, tom, strut, beam or skid or for any other than its intended purpose.

**Cleaning and maintenance of roof monitors, gutters, windows, louvres and ventilators**

**81**

*Safe means of access to be provided*

- (1) The owner of any building (other than a private domestic dwelling house) or of any structure shall provide and maintain in good order and condition, on all roofs of it permanent means of safe access to any monitors, gutters, windows, louvres, ventilators or other fixtures, parts, or equipment that require periodical cleaning or maintenance.

*Catwalks*

- (2) If catwalks are provided for the purposes mentioned in subsection (1), the catwalks shall be of hardwood or other approved material.
- (3) They shall be not less than 10 inches in width and if of hardwood not less than 2 inches in thickness.

<b>Part 5</b>	Safeguards and measures to be taken for securing the safety and health of persons engaged in building work
<b>Division 5.2</b>	Constructing, erecting, adding to, altering, repairing, finishing, painting and cleaning buildings and structures

Section 82

---

- (4) The upper surfaces of all catwalks shall be approximately horizontal in transverse planes and the surfaces shall be flat and free from obstructions or projections.
- (5) Catwalks shall be adequately supported and positively and strongly secured in position.
- (6) If catwalks are inclined longitudinally at more than 10° to the horizontal, or if they are so placed that a person, or object could fall a distance of more than 6 feet from them, they shall be fenced in accordance with section 75.

## Window cleaning

### 82

#### *Definitions*

- (1) In this section:

***anchor*** means a fitting secured to a window frame or wall to which fitting a safety strap or line terminal is or is intended to be attached.

***body belt*** means a belt constructed to fit the body, at or about the waistline, of a person engaged in window cleaning.

***safety belt*** means the complete assembly of body belt, safety strap or line and all fittings.

***safety strap or line*** means the safety strap or line that passes through loops fitted at the back of a body belt and is provided with terminal fittings to enable each of its terminals to be secured to an anchor.

***window cleaning*** includes the operations of washing, wiping or other method of cleaning windows of buildings.

*Liabilities of owners*

- (2) The owner of a building, the windows of that are cleaned from the outside, shall install and maintain anchors on each such window, the lowest part of the frame of which is more than 12 feet above the ground or adjoining flat roof, or the owner shall provide other approved safe means for cleaning every such window of such building.
- (3) The owner of any building shall not require, permit, suffer or allow any window in such building to be cleaned unless anchors or other approved means are provided to enable such work to be done in a safe way.

*Liabilities of contractors*

- (4) Every contractor shall use and require his or her employee to use while engaged in window cleaning the equipment and safety devices required by this section to be provided and used.

*Exemption—cleaning exterior face of windows from inside*

- (5) This section shall not apply to any window that is constructed in an approved way so that the exterior face can be and is cleaned entirely from the inside and during which cleaning operation no part of the window cleaner's body except 1 arm or hand is required to project beyond the frame in which the window is set.

*Exemption—windows on balconies, fire-escapes and flat roofs*

- (6) This section shall not apply to any window opening on a balcony having a railing 36 inches high, nor to a window opening on a fire-escape, nor to any window opening on a roof if the roof has a pitch of not more than 1 inch in 12 inches, is 6 feet or more in width and is capable of safely sustaining the weight of the window cleaner and his or her equipment.

<b>Part 5</b>	Safeguards and measures to be taken for securing the safety and health of persons engaged in building work
<b>Division 5.2</b>	Constructing, erecting, adding to, altering, repairing, finishing, painting and cleaning buildings and structures

Section 82

---

*Exemption—cleaning inside face of windows*

- (7) This section shall not apply to the cleaning of the inside face of any window except if the window cleaner performs the operation while resting on a level that is more than 6 feet above a floor.

*General requirements—windows more than 12 feet above ground*

- (8) No person shall clean a window required to be provided with anchors unless the person wears an approved type of safety belt and the person shall only clean the windows while the safety strap or line terminals are in position on the anchors, provided that windows may be cleaned by any other safe means that are approved or are permitted by this section.

*General requirements—portable auxiliary sills*

- (9) If any window is by this section required to be cleaned by a person wearing a safety belt and the sill of the window extends less than 6 inches out from the window frame or is inclined at a slope of more than 1 in 12 or is otherwise unsafe for the person to stand on, the owner shall provide an approved portable auxiliary sill or other approved device on which the person can stand with safety.
- (10) Every such portable sill shall be not less than 10 inches wide and it shall be equal in length to the clear width of the window opening, less 3 inches.
- (11) Every such portable sill and other device shall be so designed and constructed that it is safely held in place and so that it can be safely and readily put into position and removed.



*General requirements—limitation on use of safety belts and anchors*

- (12) Anchors shall be deemed adequate safety devices only if the window and its approaches are so constructed and maintained that the window cleaner can safely reach the sill and attach 1 safety strap or line terminal to the anchor before stepping out on to the sill and if it is possible for 1 belt terminal to remain attached to the anchor while the window cleaner steps back into the building.
- (13) No person shall use a safety belt in any place where it is liable to be detrimentally affected by acids or other deleterious chemicals.

*General requirements—use of corrosive substances*

- (14) Acids or other deleterious chemicals may be used for window cleaning only under the following conditions:
  - (a) scaffolding, conforming to the provisions of this regulation, shall be used but if scaffolding of the light swinging stage type is used it shall be suspended by flexible steel wire rope instead of fibre rope;
  - (b) the use of fibre rope in connection with any scaffolding for this purpose is prohibited;
  - (c) a highly dilute solution (not more than 5%) of hydrochloric (muriatic) acid or hydrofluoric acid shall be used;
  - (d) the window cleaner shall wear rubber gloves and shall apply the acid solution with a brush;
  - (e) all parts of the scaffolding and other equipment so used shall be liberally washed with water after each use to prevent corrosive reactions.

<b>Part 5</b>	Safeguards and measures to be taken for securing the safety and health of persons engaged in building work
<b>Division 5.2</b>	Constructing, erecting, adding to, altering, repairing, finishing, painting and cleaning buildings and structures

Section 82

---

*General requirements—maintenance of equipment*

- (15) All equipment and safety devices required by this section shall be maintained by the owners of them in good order and condition and in accordance with this regulation.

*General requirements—detachable draft deflectors*

- (16) Detachable draft deflectors fitted to window openings shall be removed before a window cleaning operation is begun.

*General requirements—broken sash chains or cords*

- (17) No person shall clean a window having broken sash chains or cords.

*General requirements—skilled operators for scaffolding and boatswain's chairs*

- (18) Only experienced and properly trained persons shall be permitted or employed to clean windows by working on scaffolding or in boatswain's chairs.

*General requirements—screws and expansion bolts*

- (19) No person shall use wood screws, coach screws, or expansion bolts as a means of fastening anchors.

*General requirements—passing from window to window prohibited*

- (20) A window cleaner shall not pass on the outside of a building from one window to another window.

*General requirements—wide fixed sash windows*

- (21) Wide fixed sash windows, having adjacent to them an openable small window separated by a mullion from it, shall have 2 anchors installed on each mullion.

- (22) The window cleaner shall attach both safety strap or line terminals to the anchors on 1 mullion so as to permit  $\frac{1}{2}$  of the larger window to be cleaned from each side.

*General requirements—wide window frames*

- (23) In buildings where the width of a window frame exceeds 6 feet there shall be installed special approved anchors, additional to other anchors, required by this section, at each side of the window frame.
- (24) These special anchors shall be set 42 inches above the window sill.
- (25) The owner shall provide for each such window, when it is being cleaned, an approved cable to be attached to the special anchors to form a back support for the window cleaner.

*Installation and maintenance of anchors—anchors for all buildings*

- (26) All anchors required by this section shall be installed as specified in this section except as may be otherwise approved.
- (27) All anchors and anchor fastenings shall be provided with means to prevent them inadvertently turning, backing off or becoming loose.

*Installation and maintenance of anchors—anchor location*

- (28) Anchors shall be attached to the side frames of the window or to the building at a point not less than 44 inches nor more than 51 inches above the window sill.
- (29) Care shall be taken, when screwing up anchor fastenings, to prevent producing excess stresses.

<b>Part 5</b>	Safeguards and measures to be taken for securing the safety and health of persons engaged in building work
<b>Division 5.2</b>	Constructing, erecting, adding to, altering, repairing, finishing, painting and cleaning buildings and structures

Section 82

---

*Installation and maintenance of anchors—timber—existing and new buildings*

- (30) Anchors shall be attached to timber or metal-covered timber window frames by bolts of not less than  $\frac{3}{8}$  of an inch in diameter that shall pass through the entire window frame and shall be securely fastened by a nut and washer.
- (31) The diameter of the washer shall be at least twice the diameter of the bolt hole.
- (32) The ends of the bolts shall be upset to prevent loosening or removal of the nuts.
- (33) The back face of anchors for installation on timber window frames or mullions shall be provided with at least 2 sharp lugs to prevent turning of the anchor after installation, or other equally effective methods may be used.

*Installation and maintenance of anchors—masonry and brickwork—new buildings*

- (34) Anchors attached to walls of masonry or brickwork units, erected after 19 September 1957, shall be installed while the wall is under construction and shall be shaped to build into the joints between masonry or brickwork units.
- (35) The anchors shall be not less than 8 inches long, have a cross-sectional area of not less than  $\frac{1}{4}$  of a square inch, have a fluke or flukes having a holding surface of not less than 1 inch in length and, be firmly embedded in the masonry or brickwork.

*Installation and maintenance of anchors—masonry and brickwork—existing buildings*

- (36) Anchors shall not be installed in existing masonry or brickwork but shall be attached to the window frames in accordance with subsections (30) to (33), subsection (38) or subsections (39) to (42), as the case may be.

*Installation and maintenance of anchors—concrete—new and existing buildings*

- (37) Anchors shall not be installed in new or existing concrete but shall be attached to the window frames in accordance with subsections (30) to (33), subsection (38) or subsections (39) to (42), as the case may be.

*Installation and maintenance of anchors—hollow metal—existing and new buildings*

- (38) Anchors shall be attached to hollow metal construction as follows:
- (a) at least 2 bolts not less than  $\frac{3}{8}$  of an inch in diameter and of proper length shall pass through the frame and a steel reinforcing plate at least  $\frac{5}{16}$  of an inch thick, not less than 6 inches long and  $\frac{3}{4}$  of an inch wide, placed on the inside of the frame and secured by means of nuts and lock washers;
  - (b) if it is impracticable to provide nuts and lock washers the reinforcing plate may be tapped to receive  $\frac{3}{8}$  inch diameter machine screws and machine screws shall pass through the plate;
  - (c) if the screw bolt is an integral part of the anchor—it shall be at least  $\frac{1}{2}$  inch in diameter and shall be secured by means of a nut and lock washer and a steel reinforcing plate as described in paragraphs (a) and (b) or it may be screwed into a tapped hole in the reinforcing plate;

<b>Part 5</b>	Safeguards and measures to be taken for securing the safety and health of persons engaged in building work
<b>Division 5.2</b>	Constructing, erecting, adding to, altering, repairing, finishing, painting and cleaning buildings and structures

Section 82

---

- (d) all anchors and anchor fastenings shall be provided with means to prevent them from turning, backing off or becoming loose.

*Installation and maintenance of anchors—solid metal—existing and new buildings*

- (39) Anchors shall be attached to solid metal frames by at least 2 bolts not less than  $\frac{3}{8}$  of an inch in diameter and of proper length, which shall pass through the frame and be secured on the inside by a nut and lock washer.
- (40) However, if it is impracticable to provide such nuts and lock washers, the frame shall be tapped its entire thickness and the screw fastenings shall extend through the frame.
- (41) In such instances at least  $\frac{5}{16}$  of an inch of thread shall be provided in the frame, otherwise a tapped reinforcing plate as specified in subsection (38).
- (42) If the screw bolt is an integral part of the anchor, it shall be at least  $\frac{1}{2}$  an inch in diameter and shall be secured to the frame by means of a nut and lock washer or the frame member may be tapped through to receive the screw bolt provided the metal is at least  $\frac{3}{8}$  of an inch thick.

*Installation and maintenance of anchors—maintenance of anchors*

- (43) The owner of every building shall maintain all anchor installations in a safe condition.

*Anchor material and specifications—anchors*

- (44) Anchors shall not be made of any of the copper base alloys such as brass, bronze, silicon bronze, aluminium bronze or similar alloys.
- (45) Anchors shall not be cast but shall be forged or machined from approved corrosion resistant rolled metal alloy.

- (46) Every forging made of such alloy shall be heat treated in an approved way.
- (47) Every anchor shall be free of imperfections and all corners of an anchor shall be properly filleted or rounded.
- (48) If bolt or set screw fastenings are used, the forgings shall be spot faced to receive the bolt or set screw head.
- (49) Anchor heads shall conform to the dimensions mentioned in schedule 7, plate 1, figures 1 and 2.

*Anchor material and specifications—bolts and set screws*

- (50) Bolts and set screws used to fasten anchors shall not be made of any of the copper base alloys mentioned in subsections (44) to (49).
- (51) The bolts and set screws shall not be cast but shall be forged or machined from approved corrosion resistant rolled metal alloy.
- (52) Each bolt and set screw shall have an unthreaded part of the shank not less than  $\frac{3}{16}$  of an inch in length adjacent to its head.
- (53) The junction of the head and shank shall not form a sharp corner.

*Anchor material and specifications—corrosion resistant metal*

- (54) In this section:

***corrosion resistant metal*** means a metal so alloyed as to provide resistance to rust and corrosion under normal atmospheric conditions.

- (55) Such metal shall be so processed as to conform to the best current practices to minimise segregation, oxides, flaws and internal stresses and shall have a minimum tensile strength of not less than 55,000 pounds per square inch with an elongation of 25% in 2 inches.

<b>Part 5</b>	Safeguards and measures to be taken for securing the safety and health of persons engaged in building work
<b>Division 5.2</b>	Constructing, erecting, adding to, altering, repairing, finishing, painting and cleaning buildings and structures

Section 82

---

- (56) Such metal where specified to be used in the manufacture of devices required in this section shall be approved.
- (57) Two tensile test bars shall be taken from each heat or batch of pieces at the time of forging or from bar stock of machined items for use by the chief inspector in performing the tests the chief inspector considers necessary.

*Safety belts—approved safety belts to be provided*

- (58) The person employing, directing or suffering another to clean windows provided with anchors shall provide or cause to be provided a properly fitting approved safety belt if the cleaning of the windows requires any part of the window cleaner's body other than 1 arm or hand to project beyond the frame in which the window is set.

*Safety belts—construction*

- (59) Straps used in the construction of safety belts shall be of woven fabric or cotton or manilla rope and shall be made of first quality material, which shall be treated against mildew by a non-acid and non-corrosive anti-mildew agent.
- (60) Stitching of the material shall be done with hot waxed, best quality linen thread and shall be lock stitching.
- (61) Fabric ends shall be bound or dipped in wax to prevent unravelling.

*Safety belts—approval test of safety belts*

- (62) Before approval by the chief inspector of a safety belt, a sample of the belt shall be tested in accordance with the following subsections.
- (63) The test shall be performed by a recognised, disinterested authority, acceptable to the chief inspector.



- (64) Two copies of the report of the testing authority, which shall include a detailed description of the test sample, the test procedure and test results, shall be submitted to the chief inspector with the application for approval.
- (65) The complete assembly of the safety belt shall be capable of holding a 250 pound weight falling free for a distance of 4 feet.
- (66) For the purposes of the test—
- (a) the test weight shall be a rigid object 45 inches in girth and having a weight of 250 pounds; and
  - (b) it shall be held by the body belt that shall be secured by the belt buckle in the same way as when the belt is worn by a window cleaner; and
  - (c) 1 belt terminal shall be attached to a rigid anchor; and
  - (d) the test weight shall fall free for a distance of 4 feet from a point in vertical alignment with the point of suspension.
- (67) A safety belt or any of its parts that have been used for testing purposes shall not afterwards be used.

*Safety belts—metal thimbles*

- (68) Metal thimbles shall be provided if safety straps or lines are secured to eyes or rings.
- (69) Fabric straps shall be reinforced with leather at such points of wear.
- (70) Thimbles for fabric straps shall run free, shall be finished smooth throughout and shall have rounded edges.

<b>Part 5</b>	Safeguards and measures to be taken for securing the safety and health of persons engaged in building work
<b>Division 5.2</b>	Constructing, erecting, adding to, altering, repairing, finishing, painting and cleaning buildings and structures

Section 82

---

*Safety belts—terminals and other metal fittings*

- (71) Safety strap and line terminals and other safety belt metal fittings subject to stress during use shall not be cast but shall be forged or machined from approved corrosion resistant rolled metal alloy.
- (72) If steel is used, it shall conform to an approved specification.
- (73) The finished product shall be free of imperfection.
- (74) After forging, the metal shall be properly heat treated.
- (75) Such terminals and other metal fittings shall meet the strength requirements of subsections (30) to (33).
- (76) The dimensions of terminal slots shall conform to the dimensions mentioned in schedule 7, plate 1, figure 3.
- (77) An approved safety catch shall be included as part of each safety strap or line terminal.

*Safety belts—method of use*

- (78) A window cleaner using a safety belt shall attach 1 safety strap or line terminal to an anchor before stepping out on to a window sill and 1 safety strap or line terminal shall remain attached to an anchor while the window cleaner is stepping back into the building.
- (79) During window cleaning, both safety strap or line terminals shall be attached to anchors.

*Maintenance of safety belts—examination*

- (80) All safety belts shall be frequently examined by the person employing, directing or permitting another to engage in window cleaning and they shall also be examined by the window cleaner before use each day and no belt shall be used that does not provide the safety required by this section.

*Maintenance of safety belts—storage and handling*

- (81) All safety belts shall be so stored and handled as to prevent rust or injury to them.
- (82) Safety belts shall not be stored in the same room with acids or other deleterious chemicals.

*Maintenance of safety belts—affected by mildew or corrosive agent*

- (83) No safety belt shall be used that has been affected by mildew, by the action of acid, or by any other corrosive or deleterious chemicals.

*Wear and replacement—safety straps and lines*

- (84) Safety straps or lines that have become damaged or unduly worn or show broken threads or fibres shall be replaced by new straps or lines.

*Wear and replacement—belt terminals*

- (85) No belt terminal shall be used if any point in the slot will accommodate a  $\frac{9}{16}$  of an inch plug gauge.

*Wear and replacement—links*

- (86) No link shall be used in a safety strap or line if any dimension of a section of it is less than 0.300 inch.

*Use of ladders in window cleaning—when to be used*

- (87) No person shall use a ladder for window cleaning except if the windows cannot be cleaned safely and practicably by other approved means.

<b>Part 5</b>	Safeguards and measures to be taken for securing the safety and health of persons engaged in building work
<b>Division 5.2</b>	Constructing, erecting, adding to, altering, repairing, finishing, painting and cleaning buildings and structures

Section 83

---

*Use of ladders in window cleaning—prevention of slipping*

- (88) All ladders used in connection with window cleaning shall be provided with approved means to prevent slipping.

*Use of ladders in window cleaning—person to hold ladder*

- (89) No person shall use a ladder more than 18 feet in length for window cleaning unless a person is stationed at all times at the foot of the ladder to hold it in place while the window cleaner is on it.
- (90) The person at the foot shall face the ladder and hold it with both hands.
- (91) The provisions of this section shall not apply to any private domestic dwelling house.

## Spray painting

83

*Definitions*

- (1) In this section:

***spray painting*** means coating interiors of buildings or coating other structures by spraying with lead paint, silica paint, enamel, vitreous enamel, lacquer or other material.

***flammable liquid*** means a liquid that, when tested in the way mentioned in the *Inflammable Liquid Act, 1915-1946*, schedule, gives off an inflammable vapour at a temperature less than 90° Fahrenheit.

***lead paint*** means any paint, paste, spray, stopping, filling or other material used in painting, that, when tested in the way prescribed in schedule 5, yields to an aqueous solution of hydrochloric acid, a quantity of soluble lead compound exceeding, when calculated as lead monoxide, 5% of the dry weight of the part taken for analysis.

*silica paint* means any paint, paste, glaze, spray or other material that, when tested in the way prescribed in schedule 3, contains free silica to the extent of 2% or more of the dry weight of the part taken for analysis.

- (2) Except as otherwise provided in this section, the person who directly or by his or her servants or agents carries out spray painting shall be responsible for compliance with the provisions of this section.

*Prohibited substances*

- (3) The following substances shall not be used in spray painting: carbon bisulphide, carbon tetrachloride, arsenic or its compounds.

*Restricted substances*

- (4) Material used in spray painting shall not contain benzol or methyl alcohol in excess of 1%.

*Provision of fire-extinguishers*

- (5) A sufficient number of fire-extinguishers of the foam or other approved type shall be maintained in the place where any material having a nitrocellulose or inflammable liquid content is being sprayed.

*Metal containers for used cleaning rags*

- (6) Metal containers, with close-fitting lids, shall be provided for the deposit of cotton waste, cleaning rags or similar materials that have been used.
- (7) The containers shall at the close of work each day be removed from the building or structure where the spray painting operations are being carried out.

<b>Part 5</b>	Safeguards and measures to be taken for securing the safety and health of persons engaged in building work
<b>Division 5.2</b>	Constructing, erecting, adding to, altering, repairing, finishing, painting and cleaning buildings and structures

Section 83

---

*Smoking and naked lights prohibited*

- (8) No person shall—
- (a) smoke; or
  - (b) have any fire, naked light, flame or other source of ignition within any place in a building or structure where spray painting is being carried out.

*Doors to open outwards*

- (9) If any building or structure or any place within a building or structure where place spray painting is being carried out, is fitted with doors, the doors shall be arranged to open outwards.

*Ventilation of work places*

- (10) The air in any room or place where spray painting is being done shall be changed by natural ventilation, exhaust fan or other means at least 20 times in each hour.
- (11) If any spray painting is done in a confined space without such air changes, the contractor shall provide a positive pressure helmet for use by each person working in the space.

*Storage of lead and silica paint*

- (12) Lead paint and silica paint shall not be stored or kept otherwise than in receptacles legibly marked 'LEAD PAINT' and 'SILICA PAINT', respectively.
- (13) However, subsection (12) does not apply to receptacles—
- (a) containing lead paint or silica paint in actual use in spray painting; or
  - (b) for mixing lead paint or silica paint for immediate use.

*Preparation of stopping*

- (14) White lead, or sulphate of lead, shall not be manipulated or used in the preparation of painters' stopping material, except under an efficient exhaust draught so arranged as to remove the dust produced, as nearly as may be, at its point of origin.
- (15) However, subsection (14) does not apply if the stopping material is prepared by a worker solely for his or her own use.
- (16) Every person who directly or by his or her servants or agents carries out spray painting shall—
  - (a) provide and maintain for the use of all persons engaged in, or exposed to the spraying of lead paint or silica paint, approved overalls, head coverings and gloves; and
  - (b) ensure that the overalls, head coverings and gloves are thoroughly washed and cleaned at the expense of the person providing them at intervals of not more than 1 week; and
  - (c) provide and maintain for the use of every person engaged in spray painting a sufficient quantity of material capable of removing paint or spraying mixture from his or her hands and face; and
  - (d) provide for persons employed in spraying lead paint or silica paint an adequate supply of hot water for washing purposes and a sufficient supply of towels, nail brushes and soap; and
  - (e) provide approved respirators and maintain them in an efficient condition for all persons engaged in—
    - (i) spray painting in which lead paint or silica paint is used; or
    - (ii) spray painting in which any other material detrimental to health is used; or

<b>Part 5</b>	Safeguards and measures to be taken for securing the safety and health of persons engaged in building work
<b>Division 5.2</b>	Constructing, erecting, adding to, altering, repairing, finishing, painting and cleaning buildings and structures

Section 83

---

- (iii) the dry rubbing down or scraping of a surface painted with lead paint or silica paint;

and for all persons otherwise exposed to the lead paint or silica paint or to such other detrimental material.

*Sampling material used for spray painting*

- (17) When requested by an inspector a sample of any material in use or mixed for use in spray painting shall be provided by the user and this shall be taken in the presence of the inspector who shall forthwith seal the sample and give it to a competent analyst.
- (18) Should the user so desire, a second sample shall be sealed at the same time by the inspector and handed to the user.

*Health register*

- (19) Every person employing any person in spray painting shall keep a health register in which shall be entered the names of all persons employed in, or exposed to spray painting and if any employee is absent from work for 3 days or more owing to illness attributable to spray painting or exposure to it, the name of the employee, together with his or her age and address and the date of cessation from work and duration of absence, shall be entered by the contractor in the health register.
- (20) The health register kept under this section shall, on demand being made by an inspector at any reasonable time, be produced for examination.

*Duties of spray-gun operators*

- (21) Every spray-gun operator shall—
- (a) so adjust the atomisation pressure of the spray-gun as to avoid creating undue mist; and



- (b) so use a spray-gun that neither the operator nor any other worker continuously comes between the outlet of the spray-gun in operation and any fan provided for the purposes of ventilation; and
- (c) not test the spray-gun by spraying promiscuously about any room or place; and
- (d) wear the overalls, head covering and gloves prescribed in subsection (16) when engaged in or exposed to the spray painting of lead paint or silica paint; and
- (e) wear the respirators required to be provided by subsection (16) when engaged in or in connection with any of the processes referred to in that subsection.

*Duties of other persons employed*

- (22) Every person shall—
- (a) wear the overalls and head covering and gloves prescribed in subsection (16) while exposed to spray painting of lead paint or of silica paint; and
  - (b) wear the respirator required to be provided by subsection (16) while engaged in or in connection with any of the processes referred to in that subsection; and
  - (c) cause all cotton waste, cleaning rags or similar materials that have been used for cleaning up in a spray painting operation to be deposited in the metal containers provided in accordance with subsection (6); and
  - (d) refrain from smoking and from introducing, keeping, preparing or partaking of any food or drink in a room or place where a spray painting operation is being carried on; and

- (e) after being employed in, or exposed to spray painting, thoroughly cleanse his or her face and hands before partaking of food or leaving the site of the building work.

## **Division 5.3 Demolition of buildings and structures**

### **84**

- (1) This section shall apply to the demolition of any building or structure or substantial part of a building or structure.
- (2) However, subsections (6), (9) and (11) do not apply in relation to the use of explosives within the meaning of the *Occupational Health and Safety Regulation 1991*.
- (3) Except as otherwise provided in this section, the person who directly or by his or her servants or agents carries out demolition work shall be responsible for compliance with this section.
- (4) Before demolition is begun and also during the progress of the work—
  - (a) no electric cable or apparatus that is liable to be a source of danger, other than a cable or apparatus used for the operation, shall be allowed to remain electrically charged; and
  - (b) all practicable steps shall be taken to prevent danger to all persons—
    - (i) from fire or explosion through leakage or accumulation of gas or vapour; and
    - (ii) from flooding from water mains, drains or sewers.
- (5) All glazed sashes and glazed doors shall be removed or boarded up at the start of the demolition work.

- (6) Demolition of walls shall be executed storey by storey beginning at the roof and working downward.
- (7) Masonry and brickwork shall be taken down in reasonably even courses.
- (8) All walls unsupported for a height of 12 feet or more shall be protected against falling by the use of shoring or ties, or both.
- (9) If walls are thin or structurally weak, scaffolding shall be erected and workers shall work from the scaffolding for the purpose of demolishing the walls.
- (10) All practicable precautions shall be taken to avoid danger from collapse of the structure when any part of the framing is removed from a framed or partly framed building or structure.
- (11) All practicable precautions shall be taken to avoid danger from any sudden twist, spring or collapse of any steelwork, ironwork or reinforced concrete when the steelwork, ironwork or reinforced concrete is cut or released.
- (12) Demolished material, debris, or spoil shall not be allowed to remain on any floor or structure if the weight of the material exceeds the safe carrying capacity of the floor or structure.
- (13) Demolished material, debris or spoil shall be so piled or stacked that it will not endanger workers or other persons.
- (14) Accumulated dust creating material, unless thoroughly dampened, shall not be thrown or dropped from the building or structure, but shall be lowered by hoisting apparatus or removed by material chutes that are completely enclosed.
- (15) The bottom of each material chute shall be equipped with a gate or stop, with suitable means for closing or regulating the flow of material.

- (16) The gate or stop shall be kept closed except for the discharge of material.
- (17) Proper tools shall be provided and kept available to loosen material that becomes jammed in the chute.
- (18) A danger sign shall be placed at the discharge end of every chute.
- (19) During demolition, chutes, floors, stairways and other places affected shall be sprinkled frequently to keep down dust.
- (20) Stairs and stair railings shall be kept in place and in usable condition as long as possible.
- (21) Steps and landings shall be kept free from debris.
- (22) Openings in floors, unless covered or otherwise protected, shall be provided with guardrails and toe boards.
- (23) If workers or other persons may be exposed to the danger of being struck by material or objects falling from upper working levels, the exposed area shall be shut off from access by means of guardrails and danger signs shall be posted.



including workers and material does not at any time exceed 500 pounds.

*run* means a stationary incline provided as a means of ascent and descent from one level to another.

*single pole scaffolding* means a scaffolding supported from the base by but 1 row of standards, the inner edge of the working platform being supported by putlogs fixed to a wall or structure.

*suspended scaffolding* means a scaffolding the platform of which is suspended from overhead supports by round steel wire ropes and is capable of being raised and lowered by means of winches or like mechanism.

*toe board* means a board 9 inches in height erected at right angles to a scaffolding platform and tightly against the platform for protection to workers as well as to prevent material or tools falling from the a platform.

## General

### 86

#### *Scaffolding construction*

- (1) Every scaffolding and every part of scaffolding shall be of sound material, good construction, adequate strength, free from patent defects and be suitable and safe for the purpose for which it is intended.

#### *Timber*

- (2) All timber used in the construction of scaffolding shall be an approved Australian hardwood or Oregon pine (Douglas fir) or other approved timber of equivalent strength and characteristics.
- (3) Timber shall be thoroughly inspected before use.

*Working platforms—dimensions of scaffold planks*

- (4) Except as otherwise provided in this section, the cross-sectional dimensions of scaffold planks shall be not less than 9 inches by 1<sup>1</sup>/<sub>8</sub> inches if of hardwood or 9 inches by 1<sup>1</sup>/<sub>2</sub> inches if of Oregon pine.

*Working platforms—scaffold planks to be of uniform thickness*

- (5) Scaffold planks used in the construction of working platforms shall be of uniform thickness so as not to cause unevenness of surface.

*Working platforms—scaffold planks to lap*

- (6) Except as otherwise provided in this section, scaffold planks shall be lapped 9 inches over supports.
- (7) Unless approved measures are taken to prevent uplift, no plank shall overhang a support more than 9 inches.

*Working platforms—minimum width of working platforms*

- (8) Except as otherwise provided in this section, a working platform shall be not less than 18 inches in width.

*Working platforms—scaffold planks to be laid full width of frame*

- (9) Scaffold planks shall be laid over the full width of the scaffolding frame and, in laying the planks, care shall be taken to avoid traps.

*Guardrails and toe boards—where required*

- (10) Guardrails and toe boards shall be provided on the outer edges and ends of all scaffolding from which a person or object could fall a distance of 10 feet or more.

*Guardrails*

- (11) Guardrails shall be of equivalent strength and rigidity to Oregon pine timber of cross-sectional dimensions four inches by 2 inches and shall be 36 inches in height.
- (12) Guardrails of metal piping shall be not less than 1<sup>11/32</sup> inches external diameter and if of rope not less than 3 inches in circumference.
- (13) All guardrails shall be secured to uprights at intervals of not more than 8 feet.

*Toe boards*

- (14) Toe boards shall project not less than 9 inches above the top of the platform planks and shall be set up so as to leave no space between the platform planks and the toe board bottom edge.

*Fixings*

- (15) Fixings shall be steel bolts <sup>5</sup>/<sub>8</sub> of an inch in diameter with washers and nuts, lashings of round fibre rope or other approved fixing.
- (16) For timbers not more than the dimensions provided in section 87 (3) to (9) and (29) to (55), fibre rope lashing for scaffolding shall be—
  - (a) for scaffolding of more than 30 feet in height—18 feet in length by 1<sup>1</sup>/<sub>2</sub> inches in circumference; and
  - (b) for scaffolding of 30 feet or less in height the lashings—16 feet in length by 1<sup>1</sup>/<sub>2</sub> inches in circumference.
- (17) For timbers of greater dimensions the length of fibre rope lashings shall be as approved.
- (18) It shall be an offence to use a fixing that has not been approved or that does not conform to the requirements of subsections (15) to (17).



*Pipes for tubular scaffolding*

- (19) Pipes for use in the construction of tubular scaffolding shall be straight and free from indentations, corrosion and other defects.
- (20) The ends of all pipes shall be squared to ensure even bearing over the whole area of the section at joints and other connections.
- (21) The pipes shall be of the dimensions and material specified in this section.

*Fittings for tubular scaffolding*

- (22) Only approved fittings shall be used for connecting the various members of a tubular scaffolding.
- (23) All such fittings shall accurately embrace, over the whole area of their bearing surfaces, the member or members on which they are used.
- (24) If the efficacy of the fittings is dependent on frictional grip, the fittings shall not be used to transmit primary tensile forces.
- (25) Fittings having screw threads in blind bosses or nuts, in which the amount of screw thread within the nut cannot be directly observed, shall not be used.

*Electrical hazards*

- (26) Scaffolding in which a metal member is used shall not be set up within 15 feet of any overhead electricity transmission line or main or within 15 feet of any electricity transmission apparatus until the transmission line, main, or transmission apparatus has been protected in an approved way by the electricity supply authority.
- (27) Scaffolding built of timber members shall not be set up within 5 feet of any such transmission line, main, or transmission apparatus until the protection mentioned in subsection (26) has been effected.

*New types of scaffolding*

- (28) All scaffolding for which specifications have not been given in this regulation, and all patented or manufactured scaffolding, parts of scaffolding or scaffolding devices, and all types of scaffolding developed subsequent to 25 May 1950 shall be of an approved type.

*Repair of damaged scaffolding*

- (29) Any scaffolding that has been damaged or weakened by any cause shall be immediately repaired and workers shall not be permitted on the scaffolding, except for the purpose of effecting repairs, until all repairs have been completed.

*Restriction on use of fibre rope*

- (30) Fibre rope shall not be used on or in connection with any scaffolding set up in any acid manufacturing plant or in any other plant where acids are generated or released in quantity or in other location where the rope is likely to be detrimentally affected by acid.

## **Construction of single and independent pole scaffolding**

### **87**

*General arrangement*

- (1) Single pole and independent pole scaffolding shall comprise a number of standards to which are fixed horizontal members (ledgers) supporting putlogs on which are laid scaffold planks, the structure thus constituted being braced, both longitudinally and transversely.

*Bracing*

- (2) This type of scaffolding shall be adequately braced in all directions to form a rigid structure capable of maintaining a wide margin of stability under all possible conditions.

*Standards*

- (3) The base of every standard shall bear on a firm footing.
- (4) If there is a possibility of settlement of any standard, the standard shall be provided with a foundation of such size and of such strength as to spread the load from the standard over a large enough area to prevent settlement.
- (5) If splices are necessary in round pole standards, butt jointed double poles shall be used instead of single poles and the double poles shall break joint at least 9 feet, poles being secured together with 2 rope lashings at the base and 1 rope lashing on each side of each butt joint.
- (6) When necessary as a protection against the impact of trucks or other heavy moving equipment, the bases of standards shall be protected from displacement by bumpers.
- (7) Sawn timber standards shall be butt jointed with 2 (two) 3-foot lengths of 4 inch by 2 inch timber fixed 1 on each side of the butt joint and bolted through with 4 <sup>5</sup>/<sub>8</sub> inches diameter bolts, fitted with washers and nuts, spaced at 9 inch centres.
- (8) Fish plates and bolts shall be symmetrically arranged at each such joint.
- (9) Joints in the standards of tubular scaffolding shall not be at distances greater than 9 inches from ledgers or other members capable of effectively constraining the joints against lateral displacement.

*Ledgers*

- (10) Each ledger shall be secured to each standard at each crossing by use of the appropriate fixing prescribed by section 86 (15) to (17).
- (11) Each ledger shall be so fixed that the greater rectilinear dimension of a section of it shall stand vertically.
- (12) Ledgers shall be continuous and kept continuous for the whole length of a scaffolding frame.

- (13) A joint shall not be made in a ledger of a single span.
- (14) Joints shall not be made in ledgers in the vicinity of the end, or outer standards.
- (15) Joints shall not be made in adjacent spans of any ledger.
- (16) If a straight ledger is supported by a row of not less than 3 standards, 1 joint only may be made in the ledger, provided that the joint is not placed at a greater distance than 2 feet 3 inches from the central standard.
- (17) If a straight ledger is supported by a row of 4 or more standards, the ledger joints may be placed at any position but not within adjacent or end spans.

*Putlogs*

- (18) Putlogs shall be set above ledgers and they shall be securely fixed to ledgers or standards.
- (19) Every putlog shall have not less than 4<sup>1</sup>/<sub>2</sub> inches bearing in walls and they shall be securely wedged in position in walls.
- (20) If one end rests on a structure, it shall be effectively secured to the structure.
- (21) A joint shall not be made in the span of a putlog.
- (22) Putlogs shall be arranged so as to provide true and even support to scaffold planks.
- (23) On each ledger at least 1 putlog within 2 feet of each standard shall remain in the scaffolding until the scaffolding is finally removed.
- (24) The spacing of putlogs in scaffolding constructed of timber shall not exceed 6 feet.
- (25) For tubular scaffolding, 1 putlog shall be placed at each side of each standard except the standards at each end of the scaffolding frame, where only 1 need be used.

- (26) The putlogs for tubular scaffolding shall be positioned not more than 9 inches from a standard measured centre-line of standard to centre-line of putlog except as provided in this section.
- (27) The maximum span of a putlog in tubular scaffolding shall not exceed 5 feet 2<sup>1</sup>/<sub>2</sub> inches for a mild steel putlog, or 4 feet 8<sup>1</sup>/<sub>2</sub> inches for a putlog of high tensile aluminium alloy measured centre to centre of supports.
- (28) If 1 end of a putlog is supported by a wall or by part of a structure, the span shall be considered as the distance between the face of the wall and the centre-line of the ledger supporting the other end.

*Heavy duty single and independent pole scaffolding not exceeding 30 feet in height—permissible loads*

- (29) The load due to the weight of people and materials uniformly distributed over the area of a scaffolding platform shall not exceed 35 pounds per square foot of platform area.
- (30) The weight of a concentrated load imposed on any bay of a scaffolding of this type shall not exceed 400 pounds provided that this load and the uniformly distributed load shall not act simultaneously.

*Heavy duty single and independent pole scaffolding not exceeding 30 feet in height—permissible number of working platforms*

- (31) Not more than 2 working platforms shall be set up and used on a scaffolding frame at any one time, but short platforms may be set up in different positions on the frame, provided that the total area of these platforms supported by any standard would not exceed that supported when 2 full length platforms are set up.

*Heavy duty single and independent pole scaffolding not exceeding 30 feet in height—height*

- (32) For subsections (29) to (31) and (33) to (43), the height of the scaffolding means the perpendicular distance measured from the base from which the scaffolding rises to the top surface of the topmost platform.

*Heavy duty single and independent pole scaffolding not exceeding 30 feet in height—standards*

- (33) All standards shall be effectively tied to the building or structure or be otherwise braced at points not more than 12 feet apart in the length of each standard, and shall be—
- (a) of sawn timber 4 inches by 3 inches sectional dimensions; or
  - (b) of timber poles not less than 3 inches diameter at the small end; or
  - (c) for tubular scaffolding only—of round metal pipes, steam quality, mild steel, or pipes of an approved high tensile aluminium alloy or other approved alloy, all such pipes being of an outside diameter of not less than  $1\frac{29}{32}$  inches, a nominal bore of  $1\frac{1}{2}$  inches and a wall thickness of not less than 0.192 inches for pipes of mild steel and 0.176 inches for pipes of an approved alloy; or
  - (d) of the other material, construction and dimensions that may be prescribed in this section or that may be approved.

*Heavy duty single and independent pole scaffolding not exceeding 30 feet in height—spacing of standards*

- (34) Sawn timber and pole standards shall be spaced not more than 10 feet apart measured from the centre-line of one standard to the centre-line of the adjacent standard in the same row.

- (35) Pipe standards in tubular scaffolding shall be spaced not more than 7 feet 6 inches apart in any row measured as mentioned in subsection (34).
- (36) If 2 or more rows of standards are used, the rows shall be spaced so as to be not more than 5 feet apart for scaffolding constructed of timber or of mild steel pipes and not more than 4 feet 6 inches apart for scaffolding constructed of pipes made of an approved aluminium alloy.

*Heavy duty single and independent pole scaffolding not exceeding 30 feet in height—ledgers*

- (37) Ledgers shall be spaced not more than 6 feet apart, provided that if circumstances so necessitate, the distance measured from the base of a scaffolding to the first ledger may be increased to not more than 10 feet, and shall be—
- (a) of sawn timber not less than 6 inches by 1<sup>1</sup>/<sub>2</sub> inches sectional dimensions if of hardwood and not less than 6 inches by 2 inches sectional dimensions if of Oregon pine; or
  - (b) of timber poles not less than 2<sup>1</sup>/<sub>2</sub> inches diameter at the small end; or
  - (c) for tubular scaffolding only—of round metal pipes of the description and dimensions mentioned in subsection (33) (c); or
  - (d) of the other material, construction and dimensions that may be prescribed in this section, or that may be approved.

*Heavy duty single and independent pole scaffolding not exceeding 30 feet in height—putlogs*

- (38) Putlogs shall be—
- (a) of sawn timber not less than 3 inches by 3 inches sectional dimensions if of hardwood and not less than 4 inches by 3 inches if of Oregon pine; or

- (b) for tubular scaffolding only—of round metal pipes of the description and dimensions mentioned in subsection (33) (c); or
- (c) of the other material, construction and dimensions that may be prescribed in this section or that may be approved.

*Heavy duty single and independent pole scaffolding not exceeding 30 feet in height—spacing of putlogs*

- (39) Sawn timber putlogs shall be spaced at not more than 6 feet apart.
- (40) For scaffolding constructed of metal pipes, a putlog shall be placed at each side of each standard except the standards at each end of the scaffolding frame, where 1 only need be used.
- (41) The putlogs for scaffolding constructed of metal pipes shall be positioned not more than 9 inches from a standard, measured centre-line of standard to centre-line of putlog.
- (42) The maximum span of a mild steel pipe putlog shall not exceed 5 feet 2<sup>1</sup>/<sub>2</sub> inches and the maximum span of a putlog of high tensile aluminium pipe shall not exceed 4 feet 8<sup>1</sup>/<sub>2</sub> inches.

*Heavy duty single and independent pole scaffolding not exceeding 30 feet in height—bracings*

- (43) Bracings shall be—
  - (a) sawn timber not less than 9 square inches in sectional area; or
  - (b) timber poles not less than 2<sup>1</sup>/<sub>2</sub> inches diameter at the small end; or
  - (c) for tubular scaffolding—round metal pipes as mentioned in subsection (33) (c); or
  - (d) of the other material, construction and dimensions that may be prescribed in this section or that may be approved.



*Heavy duty single and independent pole scaffolding exceeding 30 feet but not exceeding 150 feet in height—general*

- (44) The requirements of subsections (29) to (32) shall also apply to this type of scaffolding.

*Heavy duty single and independent pole scaffolding exceeding 30 feet but not exceeding 150 feet in height—standards*

- (45) Standards shall be—
- (a) of sawn timber not less than 4 inches by 4 inches sectional dimensions; or
  - (b) of timber poles not less than 3 inches diameter at the small end; or
  - (c) for tubular scaffolding—round metal pipes of the description and dimensions mentioned in subsection (33) (c); or
  - (d) of the other material, construction and dimensions that may be prescribed in this section or that may be approved.

*Heavy duty single and independent pole scaffolding exceeding 30 feet but not exceeding 150 feet in height—spacing of standards*

- (46) Sawn timber and pole standards shall be spaced not more than 9 feet apart measured from the centre-line of one standard to the centre-line of the adjacent standard in the same row.
- (47) Pipe standards in tubular scaffolding shall be spaced not more than 7 feet 6 inches apart in any row measured as mentioned in subsection (46).
- (48) If 2 or more rows of standards are used the rows shall be spaced so as to be not more than 5 feet apart for scaffolding constructed of timber or of mild steel pipes and not more than 4 feet 6 inches apart for scaffolding constructed of pipes of approved aluminium alloy.

*Heavy duty single and independent pole scaffolding exceeding 30 feet but not exceeding 150 feet in height—ledgers*

- (49) Ledgers shall be spaced not more than 6 feet apart, provided that if circumstances so necessitate, the distance measured from the base of a scaffolding to the first ledger may be increased to not more than 10 feet, and shall be—
- (a) of approved sawn hardwood timber not less than 6 inches by 2 inches sectional dimensions or of Oregon pine timber not less than 6 inches by 2<sup>1</sup>/<sub>2</sub> inches sectional dimensions; or
  - (b) of timber poles not less than 3 inches diameter at the small end; or
  - (c) for tubular scaffolding only—of round metal pipes of the description and dimensions mentioned in subsection (33) (c); or
  - (d) of the other material construction and dimensions that may be prescribed in this section or that may be approved.

*Heavy duty single and independent pole scaffolding exceeding 30 feet but not exceeding 150 feet in height—putlogs*

- (50) Putlogs shall be—
- (a) of sawn hardwood timber not less than 3 inches by 3 inches sectional dimensions; or
  - (b) for tubular scaffolding only—of round metal pipes of the description and dimensions mentioned in subsection (33) (c); or
  - (c) of the other material, construction and dimensions that may be prescribed in this section or that may be approved.

*Heavy duty single and independent pole scaffolding exceeding 30 feet but not exceeding 150 feet in height—spacing of putlogs*

- (51) Sawn timber putlogs shall be spaced at not more than 6 feet apart.
- (52) For scaffolding constructed of metal pipes, 1 putlog shall be placed at each side of each standard, except the standards at each end of the scaffolding frame where only 1 putlog need be used.
- (53) All putlogs for scaffolding constructed of metal pipes shall be located not more than 9 inches from a standard measured from the centre-line of the standard to the centre-line of the putlog.
- (54) The maximum span of a mild steel pipe putlog shall not exceed 5 feet 2<sup>1</sup>/<sub>2</sub> inches and the maximum span of a putlog of high tensile aluminium pipe shall not exceed 4 feet 8<sup>1</sup>/<sub>2</sub> inches.

*Heavy duty single and independent pole scaffolding exceeding 30 feet but not exceeding 150 feet in height—bracings*

- (55) Bracings shall be—
  - (a) sawn timber, not less than 9 square inches in sectional area; or
  - (b) timber poles not less than 2<sup>1</sup>/<sub>2</sub> inches diameter at the small end; or
  - (c) for light duty scaffolding—round metal pipes mentioned in subsection (33) (c); or
  - (d) of the other material, construction and dimensions that may be prescribed in this section or that may be approved.

*Light duty single and independent pole tubular scaffolding—permissible loads*

- (56) This type of scaffolding shall be used only by painters and decorators and other like tradespeople in building work of such description that the scaffolding is subjected only to small loads from the combined weight of workers and materials.

- (57) The total load due to the weight of workers and material on the platform of a light duty scaffolding shall not exceed the equivalent of a uniformly distributed load of 10 pounds per square foot of platform area.
- (58) This loading equals the combined weight of 4 workers plus material weighing 50 pounds.

*Light duty single and independent pole tubular scaffolding—height*

- (59) The height of the topmost platform shall not exceed 100 feet, such height being the distance measured from the base from which the scaffolding rises to the top surface of the platform.

*Light duty single and independent pole tubular scaffolding—permissible number of working platforms*

- (60) Not more than 2 working platforms shall be set up and used on a scaffolding frame at any time, but short platforms may be set up in different positions on the frame provided that the total area of these platforms supported by any standard would not exceed that supported when 2 full length platforms are set up.

*Light duty single and independent pole tubular scaffolding—standards*

- (61) Standards shall be of round metal pipes, steam quality, mild steel, or pipes of an approved high tensile aluminium alloy, or other approved alloy, all such pipes being of an outside diameter of not less than  $1\frac{29}{32}$  inches, a nominal bore of  $1\frac{1}{2}$  inches and a wall thickness of not less than 0.192 inches for pipes of mild steel and 0.176 inches for pipes of an approved alloy.
- (62) All standards shall be effectively tied to the building or structure or be otherwise braced at points not more than 12 feet apart, measured centre to centre.

*Light duty single and independent pole tubular scaffolding—spacing of standards*

- (63) Standards shall be spaced not more than 12 feet apart measured from the centre-line of one standard to the centre-line of the adjacent standard in the same row.
- (64) If 2 or more rows of standards are used the rows shall be spaced so as to be not more than 6 feet apart measured from the centre-line of one row to the centre-line of another row.

*Light duty single and independent pole tubular scaffolding—ledgers*

- (65) Ledgers shall be of round metal pipes of the description and dimensions mentioned in subsection (61).
- (66) Ledgers shall be spaced not more than 10 feet apart.
- (67) For this type of scaffolding the distance of a joint in a ledger from a vertical shall not exceed 1 foot 9 inches.

*Light duty single and independent pole tubular scaffolding—putlogs*

- (68) Putlogs shall be round metal pipes of the description and dimensions mentioned in subsection (61).

*Light duty single and independent pole tubular scaffolding—spacing of putlogs*

- (69) A putlog shall be placed at each side of each standard except the standards at each end of the scaffolding frame, where 1 only need be used.
- (70) The distance measured between the centre-line of a putlog and the centre-line of a standard shall be 2 feet.
- (71) The span of a putlog shall not exceed 6 feet 4<sup>1</sup>/<sub>2</sub> inches.

*Light duty single and independent pole tubular scaffolding—bracings*

- (72) Bracings shall be round metal pipes of the description and dimensions mentioned in subsection (61).

*Tubular birdcage scaffolding—permissible loads*

- (73) The total load on the platform in any bay at any time of this type of scaffolding shall not exceed the weight of 2 workers plus material weighing 50 pounds.

*Tubular birdcage scaffolding—arrangement and construction*

- (74) The general arrangement, construction and materials shall be as mentioned in subsections (56) to (72) subject to the following:
- (a) platform planks may be spaced not more than 7 inches apart;
  - (b) the span of a mild steel putlog may be increased to 8 feet and the span of a high tensile aluminium putlog may be increased to 6 feet;
  - (c) standards shall be spaced not more than 10 feet apart in any row, unless additional putlogs are provided to support cantilevered ends of platform planks;
  - (d) not more than 1 working platform shall be set up on a scaffolding frame at any time.

*Light duty single and independent pole scaffolding of 1 inch internal diameter steel tube—uses of scaffolding*

- (75) This type of scaffolding shall only be used by painters, repairers, decorators, electric welders and other like tradespeople.

*Light duty single and independent pole scaffolding of 1 inch internal diameter steel tube—tubes*

- (76) Tubes shall be mild steel round pipes of steam quality, not less than  $1\frac{11}{32}$  inches outside diameter, having walls not less in thickness than 0.16 inch.

*Light duty single and independent pole scaffolding of 1 inch internal diameter steel tube—fittings*

- (77) The fittings or devices used for connecting the various members of the scaffolding shall be only those that have been approved.

*Light duty single and independent pole scaffolding of 1 inch internal diameter steel tube—height*

- (78) The height of the topmost platform above the surface on which the scaffolding is erected shall not exceed 15 feet for scaffolding having 1 or 2 rows of standards and shall not exceed 24 feet for scaffolding having 3 or more rows of standards.

*Light duty single and independent pole scaffolding of 1 inch internal diameter steel tube—standards*

- (79) Standards shall be spaced not more than 5 feet apart measured horizontally centre to centre along any row.
- (80) If 2 or more rows of standards are used, the rows shall be spaced 3 feet 9 inches apart measured horizontally centre to centre.

*Light duty single and independent pole scaffolding of 1 inch internal diameter steel tube—ledgers*

- (81) Each ledger shall be supported by and at each standard.
- (82) The vertical distance of one ledger to the next adjacent in the height of a standard shall not exceed 6 feet.

- (83) The lowest ledger shall be fixed at a height not exceeding 18 inches above the feet of the standards.

*Light duty single and independent pole scaffolding of 1 inch internal diameter steel tube—putlogs*

- (84) Putlogs shall be connected directly to the standards and the fittings employed shall be set together as closely as is practicable.

*Light duty single and independent pole scaffolding of 1 inch internal diameter steel tube—bracing*

- (85) Diagonal bracings of steel scaffolding tubing shall be so arranged and fixed as to directly and effectively prevent longitudinal movements of all putlogs and of all ledgers.
- (86) Alternatively the putlogs shall be effectively braced from an adjacent building or structure and the bracing shall be at least of equal effect to that otherwise required.

*Light duty single and independent pole scaffolding of 1 inch internal diameter steel tube—general limitations*

- (87) In connection with this type of scaffolding no person shall—
- (a) impose or cause to be imposed on any putlog a greater total load than 470 pounds weight, inclusive of workers, tools, equipment, materials and platform timbers; or
  - (b) impose or cause to be imposed simultaneously on any scaffolding framework a greater number of working platforms than 2, but short platforms may be set up in different positions on the frame provided that the total area of these platforms supported by any part of the framework shall not exceed that supported when 2 full length platforms are set up; or



- (c) use or cause to be used in connection with the scaffolding any connector, clip, socket, fitting, jack, base, finial, fastening, wheel or caster, unless it has been approved; or
- (d) use or cause to be used any such connector, clip, socket, fitting, jack, base, finial, fastening, wheel or caster in any way or for any purpose other than that for which it has been approved, or for any greater loading than that for which it has been so approved; or
- (e) fix or use or cause to be fixed or used any putlog of greater span than 3 feet 9 inches measured horizontally centre to centre of the standards or from the centre of a standard to the nearest face of the other support; or
- (f) load or cause to be loaded any member of the scaffolding framework in any way other than that mentioned in this section.

## **Cantilever scaffolding**

### **88**

#### *General arrangement*

- (1) The general arrangement of cantilever scaffolding shall be as shown in schedule 7, plate 2.

#### *Platform width*

- (2) The platform width for this type of scaffolding shall not exceed 5 feet unless otherwise approved.

#### *Platform planks*

- (3) The platform planks shall be spiked, strapped, lashed, or wired in position to overcome creep and to prevent displacement by wind.

- (4) The dimensions of a section of any platform plank shall be not less than 10 inches by 1<sup>1</sup>/<sub>2</sub> inches for spans to 6 feet and 10 inches by 2 inches for spans exceeding 6 feet but not exceeding 10 feet.

*Guardrails and toe board*

- (5) A toe board shall be securely fixed at the open sides of all platforms and guardrails at the open sides and ends of all platforms.
- (6) Guardrails of the dimensions and description provided for by this regulation shall be fixed at the open sides and ends of all platforms.

*Cantilevers*

- (7) The length of a cantilever inside a building or structure shall not be less than 8 feet measured horizontally from the centre-line of the cantilever support to the centre of the bolt securing the inboard end to its support.
- (8) The dimensions of a section of a cantilever shall not be less than 9 inches by 2<sup>1</sup>/<sub>2</sub> inches for Oregon pine timber, or 9 inches by 2 inches for approved hardwood timber if the distance between the centre-lines of adjacent cantilevers does not exceed 6 feet.
- (9) If the distance is more than 6 feet but does not exceed 10 feet, the dimensions of the section shall be 10 inches by 2<sup>1</sup>/<sub>2</sub> inches for oregon and 10 inches by 2 inches for hardwood.
- (10) The diameter of a bolt used for fixing the inboard end of a cantilever to its support shall be not less than <sup>5</sup>/<sub>8</sub> of an inch.

*Toms*

- (11) If the inboard end of a cantilever is fixed to a tom, the dimensions of a section of the tom shall be not less than 4 inches by 3 inches.
- (12) Each tom shall rise from a pair of fox wedges, which shall be driven tight and then nailed, or it shall be fixed in an equally secure way.

*Bracing*

- (13) All toms shall be effectively braced by the use of 3 inch by 2 inch timber diagonal braces as indicated in schedule 7, plate 2.
- (14) Each cantilever shall be braced as shown in schedule 7, plate 2 by 3 inch by 2 inch timber braces.
- (15) All braces shall be fixed by bolts not less than  $\frac{1}{2}$  an inch in diameter.

**Bracket scaffolding****89***General*

- (1) In this section:

*bracket scaffolding* means a working platform supported by brackets, either of timber or metal, constructed and erected as mentioned in this section.

- (2) Bracket scaffolding shall be used only by carpenters, painters, tuck pointers, electricians, plumbers and other like tradespeople who do not require their working platform to carry quantities of materials or to withstand the effects of marked physical activity.

*General arrangement*

- (3) The general arrangement of a timber bracket scaffolding shall be as shown in schedule 7, plate 3, figure 1, provided that the brackets shall not be spaced at a greater distance apart than 14 feet.

*Construction of timber brackets—general arrangement*

- (4) The general arrangement of brackets shall be as shown in schedule 7, plate 3, figure 2 or 3.

*Construction of timber brackets—vertical legs*

- (5) The minimum length of the vertical leg of a bracket shall be 4 feet and the minimum cross-sectional dimensions shall be 4 inches by 3 inches for Oregon pine timber and 4 inches by 2 inches for hardwood timber.

*Construction of timber brackets—horizontal legs*

- (6) The overall length of the horizontal legs shall not exceed 2 feet 6 inches and the cross-sectional dimensions of the legs shall be as set out in subsection (5) for vertical legs.

*Construction of timber brackets—connection vertical to horizontal legs*

- (7) The inboard end of the horizontal leg shall sit fair and square on the upper end of a vertical leg and one shall be connected to the other either by a 14 inch by 14 inch gusset of 14 gauge mild steel plate, secured by 4 <sup>3</sup>/<sub>8</sub> inches diameter mild steel bolts, 2 in each leg as shown schedule 7, plate 3, figure 2, or by the insertion of a <sup>3</sup>/<sub>16</sub> of an inch thick mild steel plate connected by 3 (three) <sup>3</sup>/<sub>8</sub> of an inch diameter mild steel bolts as shown in schedule 7, plate 3, figure 3.

*Construction of timber brackets—bracing between vertical and horizontal legs*

- (8) If the vertical leg is connected to the horizontal by a gusset, 1 pair of braces of 3 inch by 1<sup>1</sup>/<sub>4</sub> inch timber shall be used as shown in schedule 7, plate 3, figure 2, or if a mild steel insert is used for this connection 2 pairs of braces of those dimensions shall be used for the purpose as shown in schedule 7, plate 3, figure 3.
- (9) In both cases the ends of each brace shall be cut to form a shoulder that shall bear against the horizontal and vertical legs of the bracket, respectively.

*Construction of timber brackets—handrail brackets*

- (10) Handrail brackets constructed of mild steel plate  $\frac{3}{16}$  of an inch thick shall be fixed to the outer end of the horizontal leg of each bracket by  $\frac{3}{8}$  of an inch diameter mild steel bolts as indicated in schedule 7, plate 3, figure 5 and the handrail upright shall be bolted to this bracket.

*Struts*

- (11) The strut used for holding a bracket against a wall shall not be less than 4 inches by 3 inches cross-sectional dimensions for lengths up to and including 20 feet.
- (12) The strut shall be so positioned that the 3 inch face is uppermost.
- (13) For lengths longer than 20 feet, the cross-sectional dimensions shall be so increased that a strut of equal strength is provided.
- (14) The lower ends of the struts shall be effectively secured against movement.
- (15) The angle of the struts with the horizontal shall not be greater than  $60^\circ$  or less than  $50^\circ$ , with the exception that for seasoned brickwork the angle may be flattened to between  $40^\circ$  and  $60^\circ$ .

*Bracing between struts*

- (16) Struts shall be braced one to the other as indicated in schedule 7, plate 3, figure 1.
- (17) The braces, marked 'B' in the figure, shall have cross-sectional dimensions not less than 3 inches by  $1\frac{1}{4}$  inches for both hardwood and Oregon pine, and may be spiked, clamped or bolted in position.

*Platform*

- (18) The platform may be of Oregon pine or hardwood scaffold planks.

- (19) The overall width of the platform shall not exceed 2 feet 6 inches and the minimum width shall be 1 foot 6 inches.
- (20) The scaffold planks shall be spiked or otherwise effectively secured to the brackets at each end and shall be cleated at mid length in the way shown in schedule 7, plate 3, figure 4.
- (21) If the distance between brackets does not exceed 12 feet, the thickness of the scaffold planks shall be not less than 1<sup>1</sup>/<sub>2</sub> inches for Oregon pine timber and 1<sup>1</sup>/<sub>8</sub> inches for hardwood timber.
- (22) If the distance between brackets exceeds 12 feet but does not exceed 14 feet the thickness of the scaffold planks shall be not less than 1<sup>3</sup>/<sub>4</sub> inches for Oregon pine and 1<sup>3</sup>/<sub>8</sub> inches for hardwood.

*Handrails*

- (23) Handrails shall be fixed at the outer edges and ends of all bracket scaffolding and shall be not less than 3 inches by 2 inches cross-sectional dimensions.
- (24) Handrail uprights shall be effectively and rigidly attached to the brackets as mentioned in subsection (10).

*Metal brackets*

- (25) Metal brackets shall be so designed and constructed that they conform to the appropriate design requirements of part 11.
- (26) Working platforms supported by metal brackets shall conform to the requirements of this section.

## Suspended scaffolding

### 90

#### *Loading*

- (1) Suspended scaffolding constructed and erected in accordance with this section or to an approved design and description shall not at any time be loaded, except in a bona fide test in the presence of an inspector, in excess of the maximum load permitted by this section or specified by the chief inspector in an approval.
- (2) The load on the platform over any one bay of a suspended scaffolding, constructed in accordance with this section, due to the weight of workers and materials shall not exceed 1 200 pounds and the gross weight, that is, the weight of scaffolding platforms, machine, ropes, workers and materials on any one outrigger shall not exceed 1 800 pounds or the load that is approved.

#### *Inspection*

- (3) The moving parts of every scaffolding machine shall be inspected at least twice a month and a record shall be kept of the findings of the inspections.
- (4) This record shall be accessible to an inspector at all times.
- (5) The owner of a scaffolding machine shall be notified to at once replace any defective or worn parts and the use of the machine shall be discontinued until the required replacements have been made.
- (6) In addition the owner or lessor of every scaffolding machine shall make a monthly inspection of every scaffolding machine in use and a record of the findings shall be kept.
- (7) This record shall also be accessible to an inspector at all times.
- (8) When a scaffolding machine is removed from a location, it shall be thoroughly inspected and overhauled before again being used.

*Platform*

- (9) The total width of the working platform shall not exceed 5 feet.
- (10) The working platform shall be formed of scaffold planks laid so that their edges abut and fit tight.
- (11) Scaffold planks shall be of Oregon pine not less than 10 inches wide and 2 inches thick.
- (12) Each scaffold plank shall overlap its support by at least 12 inches but not more than 24 inches at the ends of the scaffolding.
- (13) The ends of the scaffold planks of each unit, comprising 4 machines, shall be cleated and the cleats shall be made of 4 inches by 1<sup>1</sup>/<sub>2</sub> inches timber, or of 2 inches by <sup>3</sup>/<sub>8</sub> of an inch steel placed near the ends of the planks and outside the bearers and be so arranged as to ensure that the ends of the planks cannot lose their bearing on a bearer.
- (14) Each scaffold plank shall be secured to the cleats by bolts not less than <sup>3</sup>/<sub>8</sub> of an inch in diameter.
- (15) Every such platform shall be supported on bearers made of steel, or other approved metal, having a transverse strength at least equivalent to a 2 inches by 2 inches by <sup>3</sup>/<sub>8</sub> of a inch Australian Standard steel angle section.

*Guardrails and fender boards*

- (16) Guardrails constructed in conformity with this regulation shall be effectively secured at a height of not less than 3 feet above the platform surface.
- (17) Fender boards 9 inches high and 1<sup>1</sup>/<sub>2</sub> inches thick shall be effectively secured on the outside, inside and ends of each platform.

*Prevention of swaying*

- (18) Ropes or hooks shall be used and fastened to the platform of the scaffolding and to the building or structure in such way and at such



intervals as to prevent the scaffolding swaying away from the building or structure.

- (19) Likewise fenders shall be provided if required to prevent the scaffolding from swinging against the building or structure.

*Suspended scaffolding machines*

- (20) No scaffolding machine, winch or other like mechanism shall be used as the lifting or lowering mechanism of a suspended scaffolding unless drawings, or a sample of the machine, winch, or mechanism, together with a complete description in writing of how the machine, winch, or mechanism is to be set up, used, and maintained, have previously been submitted to the chief inspector and have been approved.
- (21) All such machines, winches, and mechanisms shall be designed, set up, used and maintained as provided in the section and in accordance with the approved design and description, and while in use shall be kept lubricated and maintained in an efficient state of repair, free from accumulation of dust, dirt or foreign matter.

*Wire ropes for suspended scaffolding*

- (22) Steel wire ropes of approved flexibility shall be used for suspended scaffolding.
- (23) The terminal ends of every such rope shall be effectively secured to anchorages of ultimate strength at least equal to that of the rope.
- (24) Ropes shall be evenly wound on the drum and not more rope than can be accommodated between the drum flanges shall be wound on the drum.

*Platform steel structural members*

- (25) The steel structural members of a suspended scaffolding platform shall be so designed, constructed and used that under maximum

conditions of loading the stress in each and every part of the members and in the connections of one part or member to another shall not exceed that prescribed by part 11.

*Cantilevers supporting a suspended scaffolding*

- (26) The cantilevers constituting the overhead supports for a suspended scaffolding shall be rolled steel joist sections at least equivalent in strength to a 7 inches by 3<sup>1</sup>/<sub>2</sub> inches by 15 pounds per running foot Australian Standard rolled steel joist section.
- (27) The cantilevers shall be at least 15 feet in length and they shall not project more than 6 feet 6 inches from the outside point of support on a building or structure.
- (28) These cantilevers shall be spaced at not more than 10 feet apart measured from the longitudinal centre-line of one to the longitudinal centre-line of the adjacent cantilever.

*Supports for suspended scaffolding cantilevers*

- (29) Every such cantilever shall be provided with an adequate and firm support and the support shall be so arranged that the projecting or cantilever part shall be as short as possible.

*Fixing of suspended scaffolding cantilevers*

- (30) The inner end of each cantilever shall—
  - (a) be secured to the building or structure with bolts or other suitable fittings; or
  - (b) be counterbalanced with weights in accordance with the provisions of part 11; or
  - (c) be shored from a higher floor or steel frame of a building or structure, provided that every shore used is positively secured in its correct position and in such a way that no lateral movement can occur, and provided further that every shore so used is of

adequate strength for the purpose and is so placed and fixed that undue load is not imposed on any part of the building or structure supporting the cantilever.

- (31) The bolts or other fittings mentioned in subsection (30) (a), and also the parts of the building or structure to which the cantilever is fixed, shall provide a factor of safety of at least 4 under maximum conditions of loading.

*Suspended scaffolding cantilever supports*

- (32) Every platform or structure, or beam, bearer, or other structural member used for supporting any such cantilever and the loads from it or from any counterbalance or used for supporting and transferring the weight of counterbalance to cantilever, or used for transferring the loads from a cantilever to part of a building or structure shall be of such construction that a factor of safety of at least 6 shall obtain in all timber parts, taking into consideration the resultant loads from the cantilever when the suspended scaffolding is fully loaded, and also, when the scaffolding is unloaded.
- (33) Every such platform, or structure, or beam, bearer, or other structural member shall be so constructed and fixed and secured that lateral movement cannot occur in any direction.

*Bolt diameters*

- (34) Every bolt used for anchoring a cantilever or used in connections in the structure supporting a cantilever or for securing a shore in position, or for securing bracing or other structural member shall not be less than  $\frac{5}{8}$  of an inch in diameter and shall be provided with standard washers.

*Weight of cantilever counterbalance*

- (35) The net weight of the counterbalance on any cantilever shall not be less than 3 times that necessary to balance the load on the projecting part of the cantilever when the scaffolding is fully loaded.

*Suspended scaffolding rope anchors*

- (36) A fitting of mild steel stock having sectional dimensions not less than 2 inches by  $\frac{3}{8}$  of an inch shall be fitted at the outer end of every suspended scaffolding cantilever for the purpose of anchoring the scaffolding suspension rope or rope block.
- (37) Every such fitting shall fit snug at the top and sides of the cantilever.
- (38) Each leg shall be so forged as to make an angle of not less than  $75^\circ$  with the bottom surface of the cantilever, until the inside faces of each leg are 1 inch apart.
- (39) Each leg shall then be forged so as to assume a vertical position.
- (40) The legs are to be of such length that the vertical portions are parallel for not less than  $2\frac{1}{2}$  inches.
- (41) The vertical part of each leg shall then be drilled to take a  $\frac{3}{4}$  of an inch diameter steel bolt, the centre of the bolt hole being not less than 1 inch distant from the lower bend.
- (42) A steel bolt not less than  $\frac{3}{4}$  of an inch in diameter shall be inserted in the holes in the vertical legs, the bolt nut then being screwed on and the end of the bolt riveted over, or alternatively a split pin may be fitted in a hole drilled through the bolt end outside the nut.
- (43) Every such fitting shall be secured to the cantilever by a bolt through the sides of the fitting and through the mid-section of the cantilever web or by a bolt passing through the cantilever web nearer the end of the cantilever than the spot where the fitting is positioned.

*Use of suspended scaffolding machines*

- (44) No person under 18 years old and no person unless specifically authorised by his or her employer so to do, shall work a machine, winch, or mechanism used for raising or lowering a suspended scaffolding and no person shall in any way interfere with it.
- (45) No person shall employ, instruct or direct any person under 18 years old to act in contravention of this provision.
- (46) The handles of the scaffolding machine, winch, or mechanism shall be left in that position that will prevent the platform from descending when the machine, winch, or mechanism is not actually in use for raising or lowering the platform.

*Platform to be kept level*

- (47) The process of raising and lowering a suspended scaffolding shall be such as to ensure that the working platform shall remain substantially level.

*Restrictions on use of suspended scaffolding*

- (48) Suspended scaffolding shall not be used if in the opinion of an inspector—
  - (a) the position of the scaffolding and the conditions under which the scaffolding is or would be used are dangerous to human life or limb; or
  - (b) the building or structure to which the scaffolding is attached or is proposed to be attached is not suitable for safely supporting a suspended scaffolding; or
  - (c) the scaffolding is not suitable for the work contemplated.

## Light swinging stages

### 91

#### *Designs to be submitted*

- (1) If it is impracticable to construct and use a light swinging stage of a type conforming to the requirements of this section, completely detailed working drawings together with a full description of the proposed methods of use of the light swinging stage proposed to be erected and used shall be submitted to the chief inspector and be approved before any person is allowed on the stage.

#### *Working platform*

- (2) The working platform of a light swinging stage shall be not less than 20 inches nor more than 24 inches wide and shall be formed of straight grained oregon scaffolding planks not less than 1<sup>1</sup>/<sub>2</sub> inches thick, running the full length of the platform.
- (3) These planks shall be stiffened with strong cleats fixed at the centre and immediately adjacent to each hanger.
- (4) The total length of the working platform shall not exceed 18 feet and the span of the scaffold planks from the centre-line of one hanger to the centre-line of the other shall not exceed 12 feet.
- (5) The overhang of the scaffold planks at each end shall not exceed <sup>1</sup>/<sub>4</sub> of the distance between the centre-lines of the hangers.

#### *Guardrails and toe boards*

- (6) A guardrail of straight grained Oregon pine having sectional dimensions not less than 3 inches by 2 inches or of galvanised steel water pipe of 1 inch internal diameter, or of a section and material ensuring equivalent strength and stiffness for the span, securely fastened to the hangers at not less than 30 inches above the surface of the working platform shall be provided on the outer side of the

platform, and also, if in the opinion of an inspector it is necessary in the interests of safety to human life and limb, on the inside and ends of the platform.

- (7) A toe board of not less than 6 inches by 1 inch sectional dimensions shall be provided and securely fixed on edge on the other side of the platform in all cases and if material or tools are to be loosely placed on the platform, a toe board of like section is to be provided on both sides and ends.

#### *Hangers*

- (8) The hangers supporting the working platform of a light swinging stage shall be constructed of steel bar 2 inches by  $\frac{1}{2}$  an inch sectional dimensions or of steel rod 1 inch in diameter.
- (9) Each hanger shall pass under the platform planks and shall be securely fixed to them.
- (10) The distance measured between the vertical legs of a hanger shall not exceed that necessary to accommodate the full width of the platform scaffold planks.
- (11) An anchorage of approved design shall be incorporated in the construction of each hanger, such anchorage to be used for the purpose of attaching the bottom block of the rope tackle used for raising and lowering the platform.

#### *Tackle for raising and lowering light swinging stages—rope*

- (12) The fall rope of a tackle used for raising and lowering a light swinging stage shall be constructed of Manila or sisal fibre, shall be not less than  $2\frac{1}{2}$  inches in circumference and shall be reeved through a double and a single block so as to form 4 parts of rope.
- (13) At all times other than when the stage is being raised or lowered the hauling part of the fibre rope is to be made fast with a self-locking hitch to the lower block.

*Tackle for raising and lowering light swinging stages—fibre rope blocks*

- (14) The carcase of every block for fibre rope, both single and double sheave, used in the tackle for raising and lowering a light swinging stage, shall be constructed of steel and the sheaves of each such block shall be not less than 4 inches in diameter, measured at the bottom of the rope groove.
- (15) The rope groove shall be of such size and shape as to afford ample support for the fibre rope passing over the sheave.
- (16) No such block shall, unless approved, be used in which the rope anchorage or becket is fixed to the block carcase by welding.
- (17) Rope blocks shall be adequately secured to a needle by a steel wire rope lashing or by a steel fitting designed in conformity with the requirements of part 11.
- (18) The mouth of every rope block hook shall be moused to prevent inadvertent displacement.

*Needles*

- (19) For this section, the cantilevers from which a light swinging stage tackle is suspended shall be known as *needles*.
- (20) Timber needles of at least equivalent strength to Oregon pine shall in no case be of smaller sectional dimensions than 6 inches by 4 inches and shall be placed on edge.
- (21) If needles of this minimum section are used, the point of suspension of the fall rope top block shall not be more than 2 feet from the point of bearing of the needle on the building or structure.
- (22) If this dimension cannot be kept within this limit, needles of larger sectional dimensions shall be used and the transverse strength of such larger section shall bear the same proportion to a 6 inch by 4 inch section on edge as the longer length of the cantilevered portion bears to 2 feet.



- (23) If timber needles are counterbalanced, their length shall not be less than 12 feet and not less than 9 feet of the length shall be on the counterbalanced side.

*Fixing of needles*

- (24) Needles shall either be firmly secured to the building or structure with bolts, approved steel fittings, or lashing, designed in conformity with the provisions of part 11 or they shall be counterbalanced with weights in accordance with that part.
- (25) Provision shall be made to prevent needles turning over or moving laterally, and any planking, platform or other structure provided for supporting needles or the counterbalance on needles shall have adequate strength to sustain the maximum weight imposed without undue deflection.

*Counterbalance*

- (26) The net weight of the counterbalance on any needle shall not be less than 3 times the weight necessary to balance the weight of the load on the projecting part of a needle when the stage is fully loaded.
- (27) In calculating the net weight of counterbalance, due regard shall be given to the points of suspension of the stage, the disposition of the counterbalance, and the point of substantial bearing of the needle between them.
- (28) Every such counterbalance shall be secured to the needles in a way that will prevent it accidentally shifting or being inadvertently removed.
- (29) Sand or liquids shall not be used as a counterbalance.

*Use of parapet hooks prohibited*

- (30) A parapet hook shall not be used for the purpose of suspending a light swinging stage.

*Stage to be kept level*

- (31) In raising and lowering a light swinging stage the process shall be carried out in such a way as to ensure that the platform will remain substantially level.

*Winches for light swinging stages*

- (32) A machine, winch or other mechanism may be used for raising and lowering a light swinging stage provided that—
- (a) a design; or
  - (b) a sample together with a written description of how the machine, winch or mechanism is to be set up, used and maintained;
- has previously been submitted to the chief inspector and has been approved.
- (33) All such machines, winches and mechanisms shall be designed, set up, used, and maintained as provided in the section and in accordance with the approved design and description, and while in use they shall be kept lubricated and maintained in an efficient state of repair and free from any accumulation of dust, dirt, or foreign matter.
- (34) Ropes shall be wound evenly on the drum of such machine, winch or mechanism and not more rope than can be accommodated between the drum flanges shall be wound on the drum.
- (35) The handles of all such machines, winches and mechanisms when not actually in use for raising or lowering shall be kept in that position that will prevent the stage from descending.

*Restrictions of light swinging stages*

- (36) Light swinging stages shall not be used where, in the opinion of an inspector—

- (a) the position of the scaffolding and the conditions under which the scaffolding is or would be used are dangerous to human life and limb; or
  - (b) the building or structure to which the scaffolding is attached or is proposed to be attached is not suitable for safely supporting the type of scaffolding used or proposed to be used; or
  - (c) the scaffolding is not suitable for the work contemplated.
- (37) No person under 18 years old and no person unless specially authorised by his or her employer so to do shall work a machine, winch or mechanism used for raising or lowering a light swinging stage and no person shall interfere with it.
- (38) No person shall employ, instruct, or direct any person under 18 years old to act in contravention of this provision.

*Inspection*

- (39) Immediately before the erection of a light swinging stage and at frequent intervals afterwards, the person actually responsible for erecting the stage and the scaffolder in charge of the work shall inspect all parts of the stage and its supports and satisfy himself or herself as to its safety and conformity with the section.

**Boatswain's chairs****92***Seat construction*

- (1) The seat of a boatswain's chair shall be constructed of timber not less than 1 inch in thickness and the seat shall be so arranged that a person seated in it shall have a seating space of not less than 18 inches by 10 inches.

- (2) Cleats made of timber not less than 3 inches by 1 inch sectional dimensions shall be firmly fixed to the ends of the timber, on the underside, forming the seat.

*Slings*

- (3) The slings supporting the seat of a boatswain's chair shall be of fibre rope, not less than 1<sup>1</sup>/<sub>2</sub> inches in circumference.
- (4) These slings shall be crossed underneath the chair seat and each leg shall pass through a suitable hole, 1 in each of the 4 corners of the seat and be arranged to form a loop over the seat to take a rope pulley block hook.
- (5) These slings shall be fixed to the underside of the seat to prevent the seat tilting in the slings.

*Tackle—blocks*

- (6) The rope blocks included in the tackle for suspending and raising and lowering a boatswain's chair shall be 1 (one) 2-sheave upper block and a single sheave lower block.
- (7) The carcass of each block shall be of steel and the rope anchor or becket on the bottom block shall not unless approved be fixed to the block by welding.
- (8) The rope sheaves shall be not less than 4 inches in diameter and they shall be grooved to accommodate the tackle rope.

*Tackle—rope*

- (9) The rope of the tackle suspending a boatswain's chair shall be of either Manila or sisal fibre.
- (10) The rope shall be so reeved as to form a 4-part rope tackle and shall be not less than 2 inches in circumference.

*Support*

- (11) All overhead support for a boatswain's chair shall be safely secured in position and shall be of sufficient strength to sustain not less than 4 times the weight to be suspended from it.

*Inspection*

- (12) Immediately before the erection of a boatswain's chair, and at frequent intervals afterwards, the person actually responsible for the erection of the chair, or the person in charge of the work, shall inspect the overhead supports and the tackle to see that it is safe for use and in use.

**Scaffolding for use on ships in dock or on slips****93***Large flying stages—working platforms*

- (1) The working platform of this type of scaffolding shall be Oregon pine planks not less than 12 inches by 3 inches sectional dimensions and if the distance between the ropes supporting the stage exceeds 18 feet an intermediate supporting rope shall be used.
- (2) Staging planks shall lap at least 4 feet.

*Large flying stages—stage ropes*

- (3) The stage ropes shall be flexible steel wire ropes not less than 1<sup>1</sup>/<sub>2</sub> inches in circumference and shall have a long eye spliced in one end to go round planks, the eye to be not less than 4 feet 6 inches in length.
- (4) A short eye shall be spliced in the other end to take a tail rope.
- (5) Tail ropes shall be flexible steel wire ropes not less than 1<sup>1</sup>/<sub>2</sub> inches in circumference and of sufficient length to pass over the bulwarks.

- (6) Stage ropes shall be attached to planks, in the middle of plank laps, with 1 full turn of the large eye.

*Large flying stages—guys*

- (7) A sufficient number of guy ropes shall be used to secure proper steadiness of every stage.
- (8) The guys shall be of flexible steel wire, not less than 1<sup>1</sup>/<sub>4</sub> inches in circumference with fibre tail ropes not less than 2 inches in circumference.
- (9) Guy and tail ropes shall be attached by means of spliced eyes.
- (10) All stages shall have effective end guys.

*Large flying stages—life-lines*

- (11) All stages shall be provided with life-lines of not less than 2<sup>1</sup>/<sub>2</sub> inch circumference fibre rope properly secured to the stage ropes by means of fibre rope lanyards not less than 1<sup>1</sup>/<sub>4</sub> inches in circumference at a height of not less than 2 feet 6 inches above the surface of the planks.

*Small flying stages—working platform*

- (12) The working platform of this type of scaffolding shall be Oregon pine planks not less than 12 inches by 2 inches sectional dimensions and not more than 14 feet in length.

*Small flying stages—stage ropes*

- (13) The stage ropes shall be flexible steel wire ropes not less than 1 inch in circumference and shall be attached to planks by making 1 full turn around the plank, seizing the rope beneath the plank and stapling it in position at the sides of the plank.
- (14) The stage ropes shall be attached to flexible steel wire tail ropes not less than 1<sup>1</sup>/<sub>4</sub> inches in circumference and of sufficient length to pass over the bulwarks.

*Small flying stages—distance spars*

- (15) Small flying stages shall be provided with spars securely fixed to planks, and sufficiently long to ensure effective working conditions.

*Small flying stages—life-lines*

- (16) When it is necessary for workers to work standing on small flying stages an efficient life-line shall be provided.

*Small flying stages—restriction of use*

- (17) A small flying stage shall not be used in any operation in which power operated tools are employed.

*Suspended stages for engineers and boilermakers—general*

- (18) All suspended stages for the use of engineers and boilermakers shall be so designed and constructed as to bear not less than 3 times the weight of the load to be put on them.

*Suspended stages for engineers and boilermakers—suspension*

- (19) This type of stage must be suspended from overhead catheads or needles of adequate strength properly lashed or otherwise securely and safely fixed in position.

*Suspended stages for engineers and boilermakers—working platform*

- (20) The working platform of this type of scaffolding shall comprise Oregon pine planks not less than 12 inches by 3 inches free from knots and shakes.
- (21) It shall be supported at intervals of not more than 14 feet and shall be not less than 2 planks in width.
- (22) Planks shall lap at least 4 feet.

*Suspended stages for engineers and boilermakers—platform bearers*

- (23) Platform spawls or bearers shall be of Oregon pine or other approved timber not less than 6 inches by 6 inches sectional dimensions.

*Suspended stages for engineers and boilermakers—supporting ropes*

- (24) The supporting ropes for this type of stage shall be flexible steel wire ropes not less than 1<sup>1</sup>/<sub>2</sub> inches in circumference.
- (25) They shall be secured to the overhead needles or catheads and to the plank spawls or bearers.

*Suspended stages for engineers and boilermakers—life-lines*

- (26) If the use of life-lines will not interfere with the operations being carried on and workers have to work standing on a stage, life-lines of not less than 2<sup>1</sup>/<sub>2</sub> inches circumference fibre rope shall be effectively lashed to the supporting ropes or to special stanchions by means of rope lanyards 1<sup>1</sup>/<sub>2</sub> inches in circumference.

*Suspended stages for engineers and boilermakers—guys*

- (27) Guy ropes of adequate strength and sufficient in number shall be used to secure proper steadiness of every such stage.

*Suspended stages for engineers and boilermakers—smaller stages*

- (28) Stages in which the distance between supports is appreciably less than provided for in this section may have planks and spawls of lesser dimensions than provided for in this section subject to the scaffolding having a strength equivalent to the scaffolding covered by this section.



*Engineers and boilermakers trestle scaffolds*

- (29) Trestles conforming to the requirements of this regulation may be used for supporting a working platform of adequate strength for engineers and boilermakers.

*Access to Stages*

- (30) Safe means of access shall be provided to all stages used on ships in dock or on slips.
- (31) If a builders' ladder is used as a means of access, it shall extend to a height of at least 3 feet 6 inches above the place of landing for persons using the ladder.

**Runs and ramps****94**

- (1) All runs, ramps, gangways and similar structures used as a means of communication in building work shall be of sound material, good construction, adequate strength, free from patent defects and be safe for the purposes for which they are intended.
- (2) They shall be constructed of timber planks not less than 10 inches by 2 inches sectional dimensions and shall be not less than 2 feet 6 inches wide.
- (3) When the planks overlap, the plank that runs from below shall be placed so that it laps over the one running from above.
- (4) Such planks shall be positively fixed in position.
- (5) The supports for the planks shall be of adequate strength and shall be effectively braced.
- (6) The construction of runs, ramps and gangways at an incline greater than 1 foot rise in 3 feet is prohibited.

**Part 6**            The proper design, construction, erection and use of scaffolding

Section 94

---

- (7) The planks of runs, ramps and gangways shall be cleated or otherwise fastened together to prevent unequal sagging.
- (8) If runs, ramps and gangways are more than 8 feet in height, the outside edges at least shall be provided with guardrails and toe boards.

## **Part 7**                      **Safeguards and measures to be taken for securing the safety and health of persons engaged in excavation work**

### **Division 7.1**              **General**

#### **95**

- (1) An adequate supply of timber of the required dimensions, or other approved material, shall if necessary be provided and used to prevent, so far as is reasonably practicable and as early as is reasonably practicable in the course of the work, danger to any person employed from a fall or dislodgment of earth, rock or other material forming the side of or adjacent to any excavation work.
- (2) In addition to any other examination necessary to ensure compliance with this regulation, every part of an excavation work, other than a part to which subsection (3) (a) applies, shall be specially examined before any person works in it and afterwards at least once in every period of 7 days for the purpose of ensuring compliance with this regulation and in particular to see that timber and other supports are adequate, properly secured and in good condition.
- (3) However—
  - (a) subsections (1) and (2) shall not apply if, having regard to the nature and slope of the side of the excavation and other circumstances, no fall or dislodgment of earth or other material so as to bury or trap a person employed, or so as to strike a person employed from a height of more than 5 feet is liable to occur; and

- (b) subsections (1) and (2) shall not apply in relation to a person actually engaged in timbering or other work (including an examination as mentioned in subsection (2)) that is being carried out for the purpose of compliance with subsections (1) and (2), if appropriate precautions are taken to ensure his or her safety as far as circumstances permit; and
- (c) the requirement in subsection (2) as to a special examination once in every 7 days shall not apply until the work has been in progress for a period of 5 working days (whether continuous or not).
- (4) No excavation work that is likely to reduce, so as to endanger any person employed, the security or stability of any part of any building or structure, whether temporary or permanent, shall be begun or continued unless adequate steps are taken before and during the progress of the work to prevent danger to any person employed from collapse of the building or structure or the fall of any part of it.
- (5) Timbering used to retain or support any part of an excavation work shall be of good construction, sound material and adequate strength for the purpose for which it is used.
- (6) If any timbering used to retain or support any part of an excavation work is liable to inward movement at the bottom and bracing or strutting at the bottom is not practicable, the timbering shall be adequately strutted or braced at a higher level so as to prevent such movement.
- (7) All struts, braces and walings in any excavation work shall be properly and adequately secured so as to prevent their accidental displacement or fall.
- (8) Safe means of access shall be provided to every place where persons are employed in an excavation work.

- 
- (9) If there is reason to apprehend danger to persons employed in any excavation work due to rising water or from an irruption of water or material, there shall be provided means to enable every person to reach a position of safety.
  - (10) If persons are employed in a shift and other persons are working above them, there shall be provided as early as is reasonably practicable an effective diaphragm to prevent the firstmentioned persons from being struck by tools or other objects falling from the place where the other persons are working.
  - (11) The doors in the diaphragms shall be as small as practicable, shall open upwards and shall be kept closed except when necessarily open for the passage of persons and gear.
  - (12) Every accessible part of an excavation work into which a person is liable to fall a distance of more than 6 feet shall be provided with a suitable barrier to a height of at least 3 feet and as close as is reasonably practicable to the edge.
  - (13) However, subsection (12) shall not apply to any part of an excavation work while (and to the extent to which) the absence of the barrier is necessary for the access of persons or for the movement of plant, gear, or materials or while (and to the extent to which) it has not yet been practicable to erect the barrier since the formation of that part of the excavation work.
  - (14) Material shall not be placed or stacked near the edge of any excavation work so as to endanger persons employed below.
  - (15) No load shall be placed or moved near the edge of any excavation work where it is likely to cause a collapse of the side of the excavation work and thereby endanger any person.

## **Division 7.2 Cofferdams and caissons**

### **96**

- (1) Every cofferdam or caisson and every part of it shall be of good construction, sound material, and adequate strength and shall be properly maintained.
- (2) A cofferdam or caisson shall if necessary be specially secured in position so as to prevent movement in a way dangerous to persons employed.
- (3) The bracings and ties of every cofferdam or caisson shall be properly and adequately secured to prevent their accidental displacement or fall.
- (4) The person in charge of the work of constructing, placing in position, substantially adding to, altering, or dismantling a cofferdam or caisson, and as far as possible every worker employed for any such work, shall possess adequate experience of this kind of work.
- (5) All material for the construction or fixing of a cofferdam or caisson shall be inspected on each occasion before being taken into use for such a purpose, and material that is unsuitable or defective in any respect shall not be so used.
- (6) Safe means of access shall be provided to every place where persons are employed in a cofferdam or caisson.
- (7) Adequate means for persons to reach places of safety shall be provided in every cofferdam or caisson in case of an inrush of water.

---

## **Division 7.3                      Trenches**

### **97**

- (1) All trenches of over 8 feet in length and 5 feet or more in depth in hard compact ground shall be braced at intervals not exceeding 6 feet with 6 inches by 1<sup>1</sup>/<sub>4</sub> inches hardwood runners or heavier material, placed vertically in the trench opposite each other against the trench walls.
- (2) The runners shall, if possible, extend to the bottom of the trench, otherwise as low as possible to clear the top of the pipe, sewer, conduit, or other material to be placed in the bottom of the trench.
- (3) Runners shall be supported by walings placed horizontally and held in position by screw-jacks or by struts.
- (4) Side and end walings abutting at the corners of excavations shall be joined by halving one to the other so that each waling will sustain its correct proportion of any external load imposed on them.
- (5) The cross-sectional dimensions of hardwood walings shall be not less than 6 inches by 3 inches.
- (6) Walings of other materials or timbers shall be at least of equivalent strength to hardwood walings.
- (7) Walings shall be spaced at not more than 3 feet apart measured vertically from centre to centre of walings.
- (8) Struts or screw-jacks shall be spaced at not more than 6 feet apart except at the joints of walings where they must be closer.

- (9) The cross-sectional dimensions of struts relative to the width of a trench shall be not less than is shown in table 97

**Table 97**

<b>Width of trench</b>	<b>Dimensions of strut</b>
1 foot to 2 feet 11 inches	4 inches by 3 inches
3 feet to 4 feet 11 inches	6 inches by 3 inches
5 feet to 6 feet 11 inches	6 inches by 4 inches
7 feet to 9 feet	6 inches by 6 inches

- (10) The timbering of trenches shall proceed as the work of excavation progresses.
- (11) If a mechanical digger is used the timbering shall be kept as close as practicable to the digger but the length of untimbered trench shall not exceed 10 feet, measured from the lower edge of the digger jib.
- (12) Trenches in saturated, filled, or otherwise unstable ground (other than of the nature of wet running sand) shall be close timbered.
- (13) The cross-sectional dimensions of the runners shall be not less than 6 inches by 1<sup>1</sup>/<sub>4</sub> inches for hardwood timber runners.
- (14) The cross-sectional dimensions for hardwood timber walings shall be not less than 6 inches by 3 inches and they shall be spaced as required by subsection (7).
- (15) Struts shall be of the cross-sectional dimensions prescribed by subsection (9).
- (16) If running material, as wet running sand, is encountered runners shall be kept <sup>1</sup>/<sub>2</sub> an inch apart and the spaces thus formed shall be caulked with straw or other suitable material.
- (17) If practicable straw, grass, bags, or other suitable material shall be packed behind the runners.



- (18) Walings and struts shall be of the materials and cross-sectional dimensions and shall be placed as prescribed, respectively, by subsections (5) to (7) and subsections (8) and (9).
- (19) An inspector, should the inspector considers it necessary, may order heavier timbering than that prescribed by this section.
- (20) Excavated material shall not be placed nearer than 1 foot to the edge of a trench.
- (21) For a trench in running material, provided circumstances permit, no material shall be placed nearer than 3 feet to the edge of the trench.
- (22) All trenches 5 feet or more in depth shall be supplied with 1 ladder for each 200 feet of trench or fraction of it, which ladder shall extend from the bottom of the trench to at least 3 feet 6 inches above the top.

## **Division 7.4                      Shafts, wells and tunnels**

### **98**

- (1) Every shaft and well shall be securely cased, lined or otherwise made safe.
- (2) Every drive and tunnel shall be securely protected and made safe for persons employed in it.
- (3) All entrances between the bottom of every shaft and the poppet head pulley wheel shall be securely fenced, including any entrances from an elevated platform.
- (4) Any fence or cover may be temporarily removed, to facilitate the work that is in progress, if proper precautions are taken.
- (5) If a fence or cover has been removed from any shaft entrance to allow work to proceed, 2 horizontal bars shall be fixed across the entrance not less than 2 feet nor more than 4 feet from the floor.

- (6) If access to workings is by way of a shaft and the shaft is also used for haulage purposes, the shaft shall be divided into 2 compartments, one to be used for a ladder way the other for haulage purposes.
- (7) The ladder way compartment must be securely fenced from the haulage compartment.
- (8) In addition to any mechanical means of ingress and egress, every shaft shall have at least 1 proper ladder or footway communicating from the surface to the workings.
- (9) A ladder permanently used in a shaft for the ascent and descent of persons shall not be fixed in a vertical or overhanging position, except in shafts used exclusively for pumping, and every such ladder shall be inclined at the most convenient angle that the space in which the ladder is fixed allows.
- (10) Every ladder-shaft shall have substantial platforms fixed at intervals of not more than 20 feet.

## **Part 8**                      **Safeguards and measures to be taken for securing the safety and health of persons engaged in compressed air work**

### **Division 8.1**              **Diving**

#### **99**

##### *Age limits*

- (1) No person under 20 years old or over 55 years old shall dive, and no person shall employ any such person to dive except that the upper age limit of 55 years old may be exceeded for divers with special qualifications who after special medical examination have been certified by a medical officer as being fit to continue to dive after having reached the upper age limit.

##### *Instruction*

- (2) No diver and no attendant shall engage or be employed in a diving operation unless the person has received such instruction in the work that the person is capable of carrying out his or her duties safely.
- (3) This instruction shall be such that it will impart a full working knowledge of the safe use of signals, compression and decompression tables, diving dress with its ancillary fittings and gear, of air pumps, pressure gauges and depth gauges.

##### *Appointment of medical officers*

- (4) A legally qualified doctor shall be appointed to carry out the duties prescribed by this section as being the duties of a medical officer.
- (5) The chief inspector shall be notified in writing of the name and address of the medical officer so appointed.

*Preliminary medical examinations*

- (6) No person shall dive or be employed to dive unless on or after such date the person has been examined by an appointed medical officer, and has been certified by the medical officer as being fit to work in compressed air.
- (7) The examination shall include an X-ray examination of the chest.
- (8) The medical officer's report shall be kept and produced to an inspector on demand.

*Supervision of health during diving work*

- (9) It shall be the duty of the medical officer to inform each diver at the time of a preliminary medical examination that any attack of 'bends' (pains in the joints and limbs or abdomen), giddiness, vomiting or difficulty in breathing, disease of the heart, lungs, kidneys, genital organs, a chill, or any other disease that may come on the person during or after work may have the most serious consequences to his or her health and the person shall be instructed that immediately on noticing any such indisposition the person must report it to the medical officer, or to a medical orderly, or failing either, to the contractor or a responsible representative of the contractor.
- (10) The symptoms and treatment of compressed air illness as set out in schedule 9 shall be exhibited in a conspicuous position in the divers' change room.
- (11) A contractor shall not allow any person—
  - (a) known to be suffering from bends, cold in the head, sore throat, or any other illness or disease; or
  - (b) under the influence of intoxicating liquor;to be employed under water as a diver.

- 
- (12) If divers are employed continuously in diving operations they shall be medically re-examined regularly at the following intervals:
- (a) working at depths less than 60 feet—every 6 months;
  - (b) working at depths between 60 feet and 90 feet—every 3 months;
  - (c) working at depths in excess of 90 feet—every 4 weeks,
- and unless so re-examined and found fit as mentioned in this section no person shall dive or be employed to dive.
- (13) A diver who has been absent from work due to illness of any kind for more than 7 days, or has been absent from work due to any other cause, except for recreation, for a period of more than 3 weeks shall not dive or be employed to dive without first producing a certificate of fitness from the medical officer.
- (14) No person shall dive or be employed to dive after 12 months or any lesser period that the medical officer may determine, has elapsed from the date of the last X-ray examination of his or her chest.

*Compressed air workers' badge*

- (15) It shall be the duty of a contractor to supply to every diver in the contractor's employ a compressed air worker's badge.
- (16) It shall be the duty of every diver at all times to wear a compressed air worker's badge.
- (17) A compressed air worker's badge shall be made of non-corrodible metal and shall be arranged to be worn either in a coat lapel or suspended by a chain or cord placed around the neck.
- (18) The badge shall be in the form of a disc, 1<sup>1</sup>/<sub>4</sub> inches in diameter and not less than 1<sup>1</sup>/<sub>16</sub> of an inch in thickness.
- (19) The face shall bear the following inscription, arranged in the following way:



*Safe diving periods*

- (20) Except in case of emergency, no person shall dive or be employed to dive under water in any period of 24 hours for longer than the total times and periods corresponding to the depth of dive set out in table 99.1:

**Table 99.1 Safe diving periods for varying depths\***

depth of dive feet	pressure lb. per sq. inch	safe diving period*		
		hours	minutes	
0—42	0—18 <sup>1</sup> / <sub>2</sub>	6	0	provided that the period of any dive shall not exceed 1 <sup>1</sup> / <sub>2</sub> hours duration, and that 15 minutes is allowed on the surface after each such period
42—60	18 <sup>1</sup> / <sub>2</sub> —26 <sup>1</sup> / <sub>2</sub>	5	0	provided that the period of any dive shall not exceed 1 hour duration, and that 15 minutes is allowed on the surface after each such period

depth of dive feet	pressure lb. per sq. inch	safe diving period*		
		hours	minutes	
60—66	26 <sup>1/2</sup> —29 <sup>1/2</sup>	3	0	provided that the period of any dive shall not exceed 1 hour duration, and that 15 minutes is allowed on the surface after each such period
66—72	29 <sup>1/2</sup> —32	2	0	
72—78	32—34 <sup>1/2</sup>	1	30	
78—84	34 <sup>1/2</sup> —37	1	15	
84—90	37—40	1	0	
90—96	40—42 <sup>1/2</sup>	..	55	
96—108	42 <sup>1/2</sup> —48	..	40	
108—120	48—53 <sup>1/2</sup>	..	35	
120—132	53 <sup>1/2</sup> —59	..	30	
132—144	59—64 <sup>1/2</sup>	..	25	
144—156	64 <sup>1/2</sup> —70	..	20	
156—168	70—75	..	16	
168—180	75—80 <sup>1/2</sup>	..	14	

\* **Safe diving period** means the time spent within any period of 24 hours from the beginning of the first descent to the beginning of the last ascent.

(21) If, in the case of emergency, it is necessary for a diver to remain under water at a depth of 66 feet or over for a period of time exceeding the limits set out in table 99.1, the decompression of the diver shall be regulated in the way set out in schedule 7, table 7.1.

- (22) When a diver is brought to the surface with stoppages in accordance with schedule 7, table 7.1, the diver shall not dive or be employed to dive again within 12 hours except in case of grave emergency.
- (23) Should it be necessary for a diver to descend a 2nd time to a depth of 66 feet or over with an interval of less than 4 hours between the 2 descents, the following method of calculating the stoppages required shall be observed:
- (a) read from schedule 7, table 7.2 the stoppages for the 2nd dive and from schedule 7, table 7.1, the stoppages required for a dive of duration equal to that of the 2 dives combined; and
  - (b) divide the number of stoppages by 2 for those at the greater depth check the diver for the periods shown for the 2nd dive, and for the remainder check the diver for the periods shown for the combined dive, and should there be an odd number of stoppages the greater number shall be used for the dive as combined.
- (24) The tables shall be interpreted to give the diver the maximum time in the minimum depth of water.
- (25) Stoppages at 20 feet and 10 feet are the most beneficial to the diver.

#### *Decompression*

- (26) When the prescribed limits of time under water have not been exceeded, the stoppages in ascending shall be as shown in schedule 7, table 7.2.
- (27) The stoppage points shall be determined by the attendant who shall be guided by the depth gauge readings after making due allowance for gauge error.
- (28) The diver shall not be brought up from the bottom to the first stopping place at a rate faster than 1 foot in 1 second, and his or her ascent shall be at once checked if this rate is exceeded.



- (29) While the diver is ascending, the diver must undertake as much gymnastic exercise as possible, especially using those muscles that were in use on the bottom.

*Air supply*

- (30) The minimum quantity of air supplied to divers at various depths shall be as set out in table 99.2, except that during the descent the pump shall be operated at the maximum revolutions or the air supply shall be considerably increased:

**Table 99.2 Quantity of air required by a diver at various depths**

depth		quantity of air at atmospheric pressure required per minute	*number of cylinders needed	*revolutions of hand pump per Minute
Fathoms	ft	cu. ft		
0	0	1.5	1	15
2 <sup>3</sup> / <sub>4</sub>	16	2.2	1	22
5 <sup>1</sup> / <sub>2</sub>	33	3.0	1	30
11	66	4.5	2	22
16 <sup>1</sup> / <sub>2</sub>	99	6.0	2	30
22	132	7.5	4	21
27 <sup>1</sup> / <sub>2</sub>	165	9.0	4	27
33	198†	10.5	†	†

\* These figures are based on a double-acting pump with cylinder diameter 4 inches, stroke 7<sup>1</sup>/<sub>2</sub> inches, working at 80% efficiency.

† Handworked pumps are unsuitable at a depth of 180 feet and over.

- (31) Not more than 1 diver shall be supplied from each air line.

*Air Pipe*

- (32) The air pipe shall be constructed of alternate layers of rubber and canvas and shall be reinforced with steel wire.
- (33) The piping shall have been tested by the manufacturer and shall withstand a test pressure of 200 pounds per square inch without showing any appreciable increase in diameter.
- (34) The manufacturer shall provide a certificate of test for each length of pipe manufactured.
- (35) A length of about 50 feet of floating air hose may be attached to the diver's helmet to keep weight off the diver.
- (36) No person shall dive or be employed to dive under water unless—
  - (a) a sufficient number of suitable and competent persons are also employed in attendance on the diver, so as to ensure his or her safety; and
  - (b) there is provided and used suitable and sufficient diving equipment consisting of helmets, corselets, waterproof dresses to completely enclose a diver's body, and warm clothing; and
  - (c) such equipment to include at least 1 diving helmet and dress with its necessary equipment and warm clothing in excess of the number of divers under water at any one time; and
  - (d) sufficient and suitable diving plant and equipment, including air pumps, pressure gauges and means of access to and from the water are provided and properly maintained.

*Care and testing of equipment—hand pumps*

- (37) Pumps shall be maintained in an efficient condition and shall be capable of delivering the necessary quantity of air against pressure for at least 2 divers.

- (38) Particular care shall be given to the condition of the leather piston cups and piston rod glands to prevent leakage.
- (39) Pump delivery shall be measured at least every 3 months and at shorter intervals if the pump has not been performing satisfactorily.
- (40) The pump cylinder walls and pistons shall be lubricated only with olive oil or neatsfoot oil.
- (41) Standby pumps where provided and when not in use shall be turned for a period of 5 minutes at least once in every week.

*Care and testing of equipment—gauges*

- (42) Gauges shall be calibrated by a method approved by the chief inspector at least every 3 months or at shorter intervals if error is suspected.
- (43) The gauge error, as determined by test, shall be tabulated and a copy of the tabulation shall be displayed inside the pump lid.

*Care and testing of equipment—inlet valves*

- (44) Inlet valves of helmets in use shall be tested at least once in every 3 months at a pressure of not less than 15 pounds per square inch.
- (45) The springs shall be examined on every occasion before use and at least once in every day while the helmets are in use.

*Care and testing of equipment—air pipes*

- (46) Air pipes shall be tested at least once a month and immediately before each descent to a pressure equivalent to 25% greater than that at the greatest depth at which a diver is likely to work.
- (47) The air pipe shall be lashed to ring bolts on the pump chest to relieve the connection of the air pipe to the pump nozzle of any undue load from the weight of the air pipe.

- (48) The connection shall be inspected at frequent intervals.
- (49) All air pipe connections shall be effectively lashed to prevent inadvertent disconnection.

*Care and testing of equipment—ropes and lines*

- (50) Breast ropes, shot ropes and distance lines shall be of tarred hemp or other approved material.
- (51) Ropes shall be carefully handled and shall not be sharply bent.

*Care and testing of equipment—dress and equipment*

- (52) All diving dress and equipment on the works shall be kept when not in use in a substantially constructed room or locker, and such room or locker shall not be used for the storage of any other gear, tools, or equipment used on the works.

*Care and testing of equipment—general*

- (53) Air pipes, valves, cocks, corselets, helmets, diving dresses, gauges, ropes, lanyards, and all other apparatus shall be maintained in an efficient condition, cleaned with fresh water after use, drained and dried before being stored in the room or locker provided for the purpose.
- (54) Particular care shall be taken to ensure that air pipes and diving dresses are kept free from condensed moisture and from contact with grease, oil or tar.
- (55) Material for dress repairs shall be provided and made available on the site of the works.

*Warm clothing*

- (56) Separate sets of warm clothing, woollens or flannels, shall be provided for each diver.

- (57) A diver shall not be required to wear clothing previously worn by another diver unless the clothing has been first thoroughly washed and disinfected.

*Diving dress previously worn*

- (58) A diver shall not be required to wear a diving dress previously worn by another person unless the inner surfaces of the dress have been first thoroughly washed with hot water and soap and dried in the sun.

*Distance line*

- (59) A diver working on muddy or dangerous ground shall use a distance line firmly attached to the shot rope about 3 feet above the sinker.

*Power driven compressor units—high pressure air supply*

- (60) A supply of air at high pressure may be drawn for the use of divers from either the works compressor or a compressor supplying divers equipment only.

*Power driven compressor units—compressor*

- (61) The compressor shall be capable of delivering air at the required pressure and at a rate sufficient to meet the requirements of all divers, machines, tools and other compressed air equipment supplied from it.
- (62) The compressor shall be of such construction that overheating does not take place, and the lubricant used shall be odourless and shall produce a minimum amount of noxious fumes if overheating should inadvertently take place.
- (63) Provision shall be made at the compressor to prevent undue pressure building up if the delivery pipe from the compressor becomes blocked in any way.
- (64) This provision shall take the form of a safety valve on the air chest of the compressor or on the delivery pipe as it leaves the compressor.

- (65) If the air is supplied by a compressor of such construction, size, or arrangement that, in the event of a breakdown of the power unit, it cannot be instantly worked by hand, the following equipment connected in the order set down in this section shall be used in conjunction with the compressor.
- (66) First, a main air receiver of sufficient capacity shall be connected to supply the maximum number of divers with sufficient air to bring them to the surface in reasonable time in the event of a breakdown of the compressor power unit.
- (67) The pressure maintained in this receiver shall be much higher than that corresponding to the depths of water where the divers are working.
- (68) Every such air receiver shall be designed and constructed in accordance with the Standards Australia, Boiler Code.
- (69) Second, an efficient non-return inlet valve shall be connected on the receiver to prevent back flow of air for failure of the delivery pipe or its fittings.
- (70) Third, a subsidiary air receiver fitted with a spring loaded type safety valve shall be connected.
- (71) Forth, an approved type of pressure-reducing valve fitted in the pipe line between the main air receiver and the subsidiary air receiver shall be connected.
- (72) Fifth, an air filter of approved type shall be connected in the pipe line between the subsidiary air receiver and the air control panel.
- (73) Sixth, an air control panel of robust construction equipped with an air-distributing arrangement of throttle valves, depth gauges and subsidiary receiver pressure gauge, controlling the air supply to the divers shall be connected.

- 
- (74) The throttle valves shall be of the slow acting needle valve type, fitted with graduated dial and pointer and only 1 diver shall be supplied from each such valve.
- (75) The air control panel shall be connected to the air filters by suitable flexible hose and each such hose shall be so supported that undue strain is not imposed on the air filter or air control panel connectors.
- (76) Seventh, emergency air connections and stop valves on the diver's side of each throttle valve on the air control panel shall be connected.
- (77) Eighth, a manual pump or other reliable source of air supply shall be connected and shall remain connected throughout diving operations.
- (78) The fittings and equipment mentioned in subsections (66) to (77) shall be constructed, used and maintained in accordance with the Standards Australia Code for Work in Compressed Air, Part II—Diving, as at 1 July 1950.
- (79) The control of the air supply shall be in charge of a competent attendant whose duties shall be restricted to the operation of the control panel and attendance on not more than 1 diver.
- (80) When several divers are operating from the 1 air control panel, each diver shall have a separate attendant.

#### *Ladders*

- (81) Ladders for divers shall be capable of supporting a safe working load of 4 hundredweights on any one rung.

#### *Signalling system*

- (82) No person shall dive or be employed to dive under water unless—
- (a) arrangements are made for a suitable signalling system between the diver and persons on the surface; and

- (b) the diver and all persons in attendance on the diver are conversant with the signalling system.

#### *Meals*

- (83) A diver who is to work under water at a depth of over 30 feet shall not have a meal within  $\frac{1}{2}$  an hour of beginning to dive and the last meal before diving should only be a light one.

#### *Dressing and sending down diver*

- (84) The diver shall be dressed by the following routine method:
  - (a) air pipe and breast rope connected to helmet;
  - (b) telephone tested (if used);
  - (c) diver dressed in woollens;
  - (d) diving dress and shoulder pads put on;
  - (e) corselet placed on diver, care being taken to clear the inner collar of creases and with number marked on the corselet corresponding with the helmet number;
  - (f) jock strap, if used;
  - (g) boots, with buckles outward, drawn on, and lanyards if used, to be well secured above the boots around the suit;
  - (h) helmet, without front glass, to be secured in position;
  - (i) air pipe and breast rope to be secured respectively to the left and right side of the body;
  - (j) belt, with knife (if used) attached and hanging at left side, to be secured in position;
  - (k) pump to be turned to enable diver to check air pipe connections;



- (l) diver to be placed on ladder and breast rope hitched to the ladder;
  - (m) weights to be placed in position, back one first;
  - (n) helmet front glass to be screwed in position, but before doing so care is to be taken that the diver clearly understands all instructions relating to the work the diver is to undertake.
- (85) When the source of air supply is a power-driven compressor, the following precautions, additional to those mentioned in subsection (84), shall be taken:
- (a) before the helmet is secured in position, the attendant shall test the air lines and valves through their full range;
  - (b) if the diver suspects the presence of fumes or other impurities in the air supply—the diver shall report the matter to the contractor or his or her representative.

#### *Undressing Diver*

- (86) A suitable room, shed, screen or cover shall be provided for the use of a diver when undressing.
- (87) Procedure, the reverse of that required by subsections (84) and (85), shall be adopted in undressing a diver.
- (88) Each diver should do further light exercise after undressing.

#### *Attendants*

- (89) Each diver, while under water, shall have an attendant to hold the breast rope and air pipe.
- (90) A sufficient number of other workers, if warranted, shall be stationed to see that the breast rope and air pipe pay out clear and also to coil down the rope and pipe when required.

- (91) When a diver is working at depths greater than 100 feet, an additional worker shall be available, if warranted, to watch the air pipe.
- (92) Every breast rope and air pipe shall be held clear of the gunwale and shall be kept moderately taut but care shall be taken not to have them so taut as to inconvenience the diver.
- (93) The attendant shall maintain such control of the breast rope as to prevent the diver accidentally falling from staging or from rocks.
- (94) Each attendant shall give his or her whole attention to his or her charge from the time the diver steps onto the ladder until the diver returns to the surface.
- (95) The diver shall keep a close watch on the depth gauge to note changes in depth.

#### *Records*

- (96) The times of a diver's descent and ascent shall be taken by an accurate timepiece and recorded, as also shall be all changes of depth and gauge readings when a diver is working at depths greater than 16 fathoms.
- (97) All records shall be carefully preserved and made available to an inspector as and when required by the inspector.

#### *General Precautions*

- (98) The symptoms and treatment of compressed air illness as set out in the schedule 9 shall be kept exhibited in a conspicuous position on the works.
- (99) A diver who has been blown up shall be sent down again to the original depth, but care shall be exercised that the diver has a firm hold of the shot rope or that the attendants have taken in the slack of the breast rope and air pipe, before the valve is opened to allow the diver to descend.

- (100) Special care shall be taken to prevent a diver, who is working under a large flat surface, being blown up.
- (101) If the diver is inadvertently blown up, provision shall be made for the diver to be cleared without risk of injury.
- (102) When an additional pump is to be connected by means of a four-way connection, the additional pump shall be operated against the shut cock until the gauge shows the same pressure as the other pump delivering air for the diver, before the cock may be opened.
- (103) When a pump is to be disconnected with the diver down, the cock on that pump connection shall first be shut.
- (104) The air pipes serving 2 divers shall on no account be joined up to the same junction.
- (105) If 1 hand pump is used to serve 2 divers, each diver's air supply shall be independently controlled by a suitable air-distributing valve.
- (106) This section shall apply to any diving operation that is a compressed air work within the meaning of the Act.

## **Division 8.2            Tunnelling**

### **100**

- (1) This section shall apply to any tunnelling operation that is a compressed air work within the meaning of the Act.

#### *Age limits*

- (2) No person shall work or be employed in tunnelling—
  - (a) at pressures up to 30 pounds per square inch if the person is over 50 years old; or
  - (b) at pressures over 30 pounds per square inch if the person is over 45 years old.

- (3) No person under 20 years old shall work or be employed in tunnelling work in compressed air.
- (4) However, in exceptional circumstances the medical officer may set aside the age limits in individual cases.

*Appointment of medical officers*

- (5) A legally qualified doctor shall be appointed to carry out the duties that are prescribed by this section as being the duties of a medical officer.
- (6) The chief inspector shall be notified in writing of the name and address of the medical officer immediately after he or she is appointed.

*Appointment of medical officers—medical orderly*

- (7) When the working pressure exceeds 25 pounds per square inch an experienced medical orderly shall be constantly in attendance for the purpose of recompressing any person who shows symptoms of compressed air illness, and for the purpose of attending to minor injuries.
- (8) The medical orderly shall be a person approved by the medical officer and, preferably, shall be the holder of a St. John Ambulance certificate or equivalent qualification.
- (9) The medical orderly may work on other duties provided these are such that he or she will be readily available for medical orderly duties when required.
- (10) No person shall work or be employed to work in compressed air unless on or after the date the person has been examined by an appointed medical officer, and has been certified by the officer as being fit to work in compressed air.
- (11) The examination shall include an X-ray examination of the chest.

- (12) The medical officer's report shall be kept and produced to an inspector on demand.

*Supervision of health during work*

- (13) It shall be the duty of the medical officer to inform each person at the time of a preliminary medical examination that any attack of 'bends' (pains in the joints and limbs or abdomen), giddiness, vomiting or difficulty in breathing, disease of the heart, lungs, kidneys, genital organs, a chill, or any other disease that may come on the person during or after work may have the most serious consequences to his or her health and the person shall be instructed that immediately on noticing any such indisposition the person must report it to the medical officer, or to a medical orderly, or failing either, to the contractor or a responsible representative of the contractor.
- (14) The symptoms and treatment of compressed air illness as mentioned in schedule 9 shall be exhibited in a conspicuous position in the workers's change room.
- (15) A contractor shall not allow any person—
- (a) known to be suffering from bends, cold in the head, sore throat, or any other illness or disease, or
  - (b) under the influence of intoxicating liquor;
- to enter any compressed air chamber.
- (16) Persons employed continuously in compressed air shall be medically re-examined regularly at the following intervals:
- (a) at pressures not exceeding 25 pounds per square inch—every 6 months;
  - (b) at pressures exceeding 25 pounds per square inch but not exceeding 35 pounds per square inch—every 3 months;

- (c) at pressures exceeding 35 pounds per square inch but not exceeding 45 pounds per square inch—every 6 weeks;
  - (d) at pressures exceeding 45 pounds per square inch—every 4 weeks.
- (17) Unless so re-examined and found fit as mentioned in this section no person shall work, or be employed to work in compressed air.
- (18) Any employee who has been absent from work for more than 7 days owing to illness of any kind, or who has been absent from work due to any other cause, except for recreation, for a period of more than 3 weeks shall not work or be employed to work in compressed air without first producing a certificate of fitness from the medical officer.
- (19) No person shall work or be employed to work in compressed air after 12 months, or any lesser period that the medical officer may determine, has elapsed.
- (20) Every person not accustomed to work in compressed air shall be tested to the working pressure obtaining at his or her place of work by being subjected to the pressure in the medical or airlock.
- (21) If the employee shows serious symptoms after test, or after the first 2 full working periods, the employee shall not work in compressed air.

*Compressed air workers' badge*

- (22) It shall be the duty of a contractor employing persons to work in compressed air to supply to every such person a compressed air workers' badge.
- (23) It shall be the duty of every person employed or working in compressed air to, at all times, wear a compressed air workers' badge.
- (24) Every compressed air workers' badge shall be manufactured and used in the way mentioned in section 99 (17) to (19).

*Safe working periods—general*

- (25) Except in case of emergency, no person shall work or be employed to work in compressed air for longer in any period of 24 hours than the period corresponding to the pressure in which the work is carried out as set out in table 100:

**Table 100**

gauge pressure lb/in <sup>2</sup>	working period	gauge pressure lb/in <sup>2</sup>	working period
0-15	8 hours	40-50	3 hours
15-25	6 hours	50-55	2 hours
25-40	4 hours	55-60	1 <sup>1</sup> / <sub>2</sub> hours

- (26) Provided that—
- (a) the 8 hour and 6 hour working periods each include a meal break of <sup>1</sup>/<sub>2</sub> an hour; and
  - (b) the 8 hour working period includes times required for compression and decompression, but the other working periods shown in the table do not include times for those purposes nor time occupied in changing shifts.

*Safe working periods—observation period*

- (27) After decompression from pressures between 25 and 40 pounds per square inch, all persons shall be detained for observation for 45 minutes before leaving the site of the work.
- (28) This period of detention shall be increased to 1 hour after decompression from pressures between 40 and 60 pounds per square inch.

*Compression*

- (29) During compression, the pressure shall be increased gradually and uniformly to ensure that no person is distressed.
- (30) The rate of compression shall not exceed 5 pounds per square inch per minute.

*Decompression*

- (31) Decompression shall be carried out in accordance with the provisions of schedule 7, table 7.3.
- (32) However, at pressures lower than 18 pounds per square inch, decompression shall be conducted at a rate that will not inconvenience any person, but shall not be completed in less than 5 minutes.
- (33) A copy of schedule 7, table 7.3 shall be posted in the man-lock.

*Airlock attendants*

- (34) Every airlock shall be serviced only by a reliable, and specially trained and selected person.
- (35) The airlock attendant, if without previous experience of either working in or controlling airlocks, shall be specially trained.
- (36) The airlock attendant shall at no time operate more than 1 man-lock.
- (37) The airlock attendant shall remain outside the lock near the entrance, and shall not be employed for more than 8 hours in any 24 hours.
- (38) Written instructions about the gauge pressure in the working chamber and compression and decompression times shall be given to each airlock attendant.
- (39) A copy of the instructions shall be suitably exhibited in a conspicuous position near the man-lock.



---

*Airlock records*

- (40) A record of workers employed in compressed air shall be kept.
- (41) This record shall show for each employee the period of stay in the working chamber, the gauge pressure and the time taken for decompression.
- (42) When the working pressure exceeds 20 pounds per square inch, automatic recording instruments shall be installed to record the pressure in the working chamber and in the man-locks, and these records shall be carefully kept.
- (43) All the records shall be made available to an inspector on demand at all reasonable times.

*Man-lock—size*

- (44) Each bulkhead shall be provided with 1 operating man-lock and 1 emergency man-lock, each of sufficient size to hold at any one time the entire force of workers engaged in any 2 successive shifts, with a minimum of 3 square feet of floor space per worker.

*Man-lock—access*

- (45) The door between the man-lock and the working chamber shall remain open except during compression and decompression and during the procedure of passing material through the lock.
- (46) In tunnels of large diameter the emergency man-lock shall be near the roof and within the protection of the safety curtain, with proper access to it from both inside and outside.
- (47) In tunnels of small diameter if it is not practicable to provide an emergency man-lock near the roof, the emergency chamber with safety door shall be at the end of the operating man-lock nearer the working face, and shall be of the same size as the operating man-lock.

- (48) The safety door shall never be closed while there is any person in the working chamber.
- (49) Except in an emergency, the workers shall be prohibited from emerging through the material locks, or, when the material lock and the man-lock are one and the same, the material lock valves shall not be used when workers are in the lock.

*Man-lock—fittings*

- (50) Every lock in which persons are compressed or are decompressed shall be fitted with a suitable instrument panel on which shall be mounted the necessary pressure gauges in duplicate, an accurate timepiece and a copy of schedule 7, table 7.3.
- (51) The instrument panel shall be adequately illuminated.
- (52) The man-lock shall have valves both inside and outside the lock.
- (53) The valves to which the airlock attendant has not access shall be covered with a case, the door of which is locked and has a glass panel that may be broken in case of emergency so as to permit the valves to be operated.
- (54) Except in case of emergency, valves shall only be operated by the airlock attendant.

*Medical lock*

- (55) A medical lock at least 5 feet in diameter shall be provided when work is being carried out at a pressure of 25 pounds per square inch or over.
- (56) Should any case of compressed air illness occur when the working pressure is less than 25 pounds per square inch, it may be dealt with in the man-lock.
- (57) The medical lock shall have 2 compartments, so that entry may be obtained to the inner chamber while it is under pressure.

- 
- (58) The lock shall be adequately ventilated, protected from the direct rays of the sun or adequately heated if required, and shall be adequately lighted.
  - (59) The lock and its equipment shall be kept in a clean state.
  - (60) The lock shall be provided with suitable equipment including a couch not less than 6 feet in length, clean blankets, dry woollen garments, a food lock and a telephone.
  - (61) The medical lock shall be located within the immediate vicinity of the works and arrangements shall be made to ensure that the lock is ready for operation during the 12 hours after the end of any shift.
  - (62) The medical lock shall be equipped with a small, glazed aperture so that a patient under treatment in the lock can be kept under observation by the attendant from outside the lock.
  - (63) It shall be provided with a pressure gauge and an accurate timepiece for each compartment.
  - (64) The timepiece and the pressure gauge for the main compartment shall be in a position that they can be readily seen by the attendant whether the attendant is inside or outside the lock.

*Additional bulkhead*

- (65) Wherever the gauge pressure in the working chamber exceeds 30 pounds per square inch, a 2nd bulkhead with airlocks shall be provided after the tunnel has been constructed for a reasonable distance.
- (66) The working pressure in the outer section shall be maintained at approximately  $\frac{1}{2}$  of the absolute pressure in the working chamber.

*Communication*

- (67) The working chamber and the airlock shall be in telephonic communication at all times with the airlock attendant, who shall also

be provided with telephonic or other satisfactory means of communicating with the contractor or his or her representative on the works.

- (68) The contractor shall depute a representative to be at all times available for communication with the airlock attendant.
- (69) In the event of telephone failure, signals shall be transmitted by tapping.
- (70) A suitable code of signals shall be formulated on the job and a copy of this code shall be posted inside and outside the man-lock.

#### *Overhead gangway*

- (71) In all tunnels 16 feet and over in diameter or height, an overhead gangway shall be provided from the working face to the nearest airlock.
- (72) An overhead clearance of 6 feet shall be maintained unless otherwise approved.

#### *Safety curtains*

- (73) Safety curtains shall be provided in all tunnels if there is the possibility of a 'blow' causing an inrush of water or material being excavated.
- (74) The safety curtain shall at no time be distant more than 200 feet from the working face.

#### *Fire precautions*

- (75) If danger of fire exists, a fire hose at least 50 feet in length with a suitable nozzle connected, shall be provided on both sides of the tunnel bulkhead.
- (76) Water lines shall extend into the tunnel with a hose connection every 200 feet, and this system shall be maintained ready for use at all times.

---

*Lighting*

- (77) All lighting in compressed air chambers shall be by electricity only, except in cases of emergency.
- (78) One worker in the airlock shall be provided with an electric pocket lamp, and candles and damp-proof matches shall be provided in the working chamber and in each man-lock.
- (79) All portable incandescent lamps shall be guarded by a wire cage large enough to enclose both lamp and socket.
- (80) The lamps shall be constructed in accordance with the Standards Australia, Approval and Test Specification No C. 118, Electric Hand Lamps.

*Electric installation—voltage*

- (81) The voltage used for electric lighting circuits between the last bulkhead and the working face shall not exceed 32V for alternating current and 50V for direct current.

*Electric installation—wiring*

- (82) Except as otherwise provided in this regulation, all wiring for light and power circuits shall comply with the requirements of the S.A.A. Wiring Rules, for damp or hazardous locations.

*Air supply*

- (83) A minimum of 25 cubic feet of clean, fresh air shall be supplied each minute to each worker in the working chamber, and a minimum of 10 cubic feet per minute to each worker in the man-lock.
- (84) In the event of any reduction of the air pressure below a point to be specified from time to time by the engineer in charge of the work, the airlock attendant shall notify the workers in the working chamber, and

preparations shall be made immediately for their withdrawal from the working chamber.

*Free air intake*

- (85) The free air intake shall be so situated as to ensure an ample supply of clean, fresh air.
- (86) The utmost care shall be taken to avoid contamination of the air by fumes from the exhausts of compression ignition or internal-combustion engines and from all other sources.

*Purification and refrigeration of compressed air*

- (87) An approved oil separator shall be used between the compressor and the air receiver and an air filter of approved type shall be installed between the air receiver and the working chamber.
- (88) The air shall be cooled after compression, if necessary, so that the temperature in the working chamber does not exceed 80° Fahrenheit when measured with a dry bulb thermometer.

*Compressed air plant*

- (89) If the air compressor, used for supplying air under pressure for the purposes of compressed air work in tunnelling is driven by electric power, stand-by compressor plant shall be provided and shall be of such capacity that, in the event of failure of the electrically-driven units, at least 50% of the air supply may be maintained.
- (90) With other than electrically-powered compressors not more than 50% of the compressor units shall be driven from any 1 power unit and, if practicable, the power units shall be interchangeable.

---

*Air lines and fittings*

- (91) Each air line shall be equipped with the following fittings connected in the order shown:
- (a) an air receiver of such capacity as to be capable of delivering at least 2 000 cubic feet of air to the working chamber at normal working pressure, for the purpose of reserve storage in the event of failure of the compressor plant;
  - (b) a stop valve;
  - (c) a pressure-reducing valve located close to the man-lock;
  - (d) a non-return valve located close to the man-lock.
- (92) The air supply shall be through duplicate air lines between the air receiver and the working chamber.
- (93) An adjustable safety valve shall be fitted on the outside of the bulkhead to a separate pipe leading from the working chamber through the bulkhead to the outside air.

*Testing of equipment*

- (94) All locks and air receivers shall be subjected to test and inspection in accordance with the provisions of the Australian Standard Rules for the Design, Construction, Inspection and Operation of Boilers and Unfired Pressure Vessels and their Appurtenances published by Standards Australia, as revised in May, 1942.
- (95) Pressure gauges shall be installed and tested in accordance with the relevant provisions of the rules mentioned in subsection (94).

*Change rooms*

- (96) Without prejudice to the requirements of part 10 (which among other things relates to the provision of certain accommodation for the health

of persons), there shall be provided and maintained for the use of persons employed in compressed air work in tunnelling—

- (a) properly heated, lighted and ventilated change rooms and drying rooms; and
- (b) bathing accommodation, namely, 1 shower equipped with running hot and cold water for every 8 men employed on the same shift and 1 for every 8 women employed on the same shift, and 1 for any number less than 8 such men or women, as the case requires; and
- (c) suitable and adequate earth or water closets at the rate of 1 closet for every 10 men employed on the same shift and 1 for every 10 women employed on the same shift, and 1 for any number less than 10 such men or women, as the case requires.

*Information to be posted in change room*

- (97) A copy of the following information shall be posted in the change room for the information and instruction of persons employed in compressed air work in tunnelling:
  - (a) subsections (13) to (21) and (98) to (100); and
  - (b) schedule 9; and
  - (c) the name, address, and telephone number of the medical officer.

*Prohibition of smoking and intoxicating liquor*

- (98) No person shall smoke in the man-lock or in the working chamber.
- (99) No person shall carry on his or her person any smoking materials while in the man-lock or in the working chamber but shall leave all such materials in the change room.
- (100) No intoxicating liquor shall be brought into the vicinity of the working chamber, provided that the carrying of alcoholic spirits or



other stimulants into such places for medical purposes may be approved by the medical officer.

*Copy of pt 8 to be available*

- (101) A copy of this part shall be kept at the works office and shall be available to every person on the works who is engaged in the compressed air work.

## **Division 8.3            Caissons**

### **101**

*Age limits*

- (1) No person shall work or be employed in compressed air work in caissons—
  - (a) at pressures up to 30 pounds per square inch if the person is over 50 years old; or
  - (b) at pressures over 30 pounds per square inch if the person is over 45 years old.
- (2) No person under 20 years old shall work or be employed in compressed air work in caissons.
- (3) However, in exceptional circumstances the medical officer may set aside the age limits in individual cases.

*Appointment of medical officers*

- (4) A legally qualified doctor shall be appointed to carry out the duties prescribed by this regulation as the duties of a medical officer.
- (5) The chief inspector shall be notified in writing of the name and address of the medical officer so appointed.

*Medical orderly*

- (6) When the working pressure exceeds 25 pounds per square inch, an experienced medical orderly shall be constantly in attendance for the purpose of recompressing any worker who shows symptoms of compressed air illness and for attending to minor injuries.
- (7) The medical orderly shall be a person approved by the medical officer and the orderly shall be the holder of a St. John Ambulance certificate or equivalent qualifications.
- (8) The medical orderly may work on other duties provided these are such that the medical orderly will be readily available for medical orderly duties when required.

*Preliminary medical examination*

- (9) No person shall work or be employed to work in compressed air unless on or after such date the person has been examined by an appointed medical officer, and has been certified by the officer as being fit to work in compressed air.
- (10) The examination shall include an X-ray examination of the chest.
- (11) The medical officer's report shall be kept and produced to an inspector on demand.

*Supervision of health during compressed air work in caissons—advice to employees*

- (12) It shall be the duty of the medical officer to inform each person at the time of a preliminary medical examination that any attack of 'bends' (pains in the joints and limbs or abdomen), giddiness, vomiting or difficulty in breathing, disease of the heart, lungs, kidneys, genital organs, a chill, or any other malady that may come on the person during or after work in a caisson, may have the most serious consequences to his or her health, and the person shall be instructed that immediately on noticing any such indisposition the person must

report it to the medical officer, or to a medical orderly, or failing either, to the contractor or to a responsible representative of the contractor.

- (13) The symptoms and treatment of compressed air illness as set out in schedule 9 shall be exhibited in a conspicuous position in the workers's change room.

*Supervision of health during compressed air work in caissons—entry prohibited*

- (14) A contractor shall not allow any person—
- (a) known to be suffering from bends, cold in the head, sore throat, or any other illness or disease, or
  - (b) under the influence of intoxicating liquor,
- to be employed in compressed air work in a caisson.

*Supervision of health during compressed air work in caissons—periodical medical examination*

- (15) If persons work continuously in compressed air in caissons they shall be re-examined regularly at the following intervals:
- (a) for pressures not exceeding 25 pounds per square inch—every 6 months;
  - (b) for pressures above 25 pounds and not exceeding 35 pounds per square inch—every 3 months;
  - (c) for pressures above 35 pounds and not exceeding 45 pounds per square inch—every 6 weeks;
  - (d) for pressures above 45 pounds per square inch—every 4 weeks.
- (16) Unless so re-examined and found fit as mentioned in this section, no person shall work or be employed to work in compressed air.

*Examination after absence*

- (17) An employee who has been absent from work in compressed air in caissons, due to illness of any kind for a period of more than 7 days, or who has been absent from such work due to any other cause, except for recreation, for a period of more than 3 weeks shall not work or be employed to work in compressed air without first producing a certificate of fitness from the medical officer.

*New employees*

- (18) Every person who is not accustomed to work in compressed air shall be tested to the working pressure in the medical or airlock.
- (19) If any person shows serious symptoms after test, or after the first 2 full working periods, the person shall not work in compressed air.

*X-ray examination*

- (20) No person shall work or be employed to work in compressed air after 12 months, or any less a period that the medical officer may determine, has elapsed from the date of the last X-ray examination of his or her chest.

*Compressed air worker's badge*

- (21) It shall be the duty of a contractor to supply to every person engaged in compressed air work in caissons in his or her employ a compressed air worker's badge.
- (22) It shall be the duty of every person engaged in compressed air work in caissons at all times to wear a compressed air worker's badge.
- (23) A compressed air worker's badge shall be made of non-corrodible metal and shall be arranged to be worn either in a coat lapel or suspended by a chain or cord placed round the neck.

- (24) Every badge shall be manufactured in accordance with the provisions of section 99 (18) and (19)

*Working periods—general*

- (25) Except in case of emergency, no person shall work or be employed to work in compressed air for longer in any period of 24 hours, than the period corresponding to the pressure in which the work is carried out as set out in table 101.

**Table 101**

<b>gauge pressure lb/in<sup>2</sup></b>	<b>working period</b>	<b>gauge pressure lb/in<sup>2</sup></b>	<b>working period</b>
0-15	8 hours	40-50	3 hours
15-25	6 hours	50-55	2 hours
25-40	4 hours	55-60	1½ hours

- (26) Provided that—
- (a) the 8 hour and 6 hour working periods each include a meal break of ½ an hour; and
  - (b) the 8 hour working period includes times required for compression and decompression, but the other working periods shown in table 101 do not include times for those purposes nor time occupied in changing shifts.

*Observation period*

- (27) After decompression from pressures between 25 and 40 pounds per square inch, all persons shall be kept for observation for 45 minutes before leaving the site of the work.

- (28) This period of detention shall be increased to 1 hour after decompression from pressures between 40 and 60 pounds per square inch.

*Compression*

- (29) During compression the pressure shall be increased gradually and uniformly to ensure that no person is distressed.
- (30) The rate of compression shall not exceed 5 pounds per square inch per minute.

*Decompression*

- (31) Decompression shall be carried out in accordance with the provisions of schedule 7, table 7.3, provided that at pressures lower than 18 pounds per square inch decompression shall be conducted at a rate that will not inconvenience any person, but shall not be completed in less than 5 minutes.
- (32) A copy of schedule 7, table 7.3, shall be posted in the man-lock.

*Airlock Attendants*

- (33) Every airlock shall be served only by a reliable, and specially trained and selected person.
- (34) The airlock attendant, if without previous experience of either working in or controlling airlocks, shall be specially trained.
- (35) The airlock attendant shall at no time operate more than 1 man-lock.
- (36) The airlock attendant shall remain outside the lock near the entrance, and shall not be employed for more than 8 hours in any 24 hours.

*Airlock records*

- (37) A record of workers employed in compressed air shall be kept.

- (38) This record shall show for each employee the period of stay in the working chamber, the gauge pressure and the time taken for decompression.

*Man-lock—size*

- (39) The chambers serving for compression and decompression shall be of such dimensions that the space available to each person using the chambers at any time shall be at least equal to 16 cubic feet with a minimum floor space of 3 square feet per person.

*Man-lock—access*

- (40) The door between the man-lock and the working chamber shall remain open except during compression and decompression and during the procedure of passing material through the lock.
- (41) A ladder conforming to the requirements of this regulation shall be available for access to and from the working chambers.

*Man-lock—fittings*

- (42) Every lock in which persons are compressed or decompressed shall be fitted with a suitable instrument panel on which shall be mounted the necessary pressure gauges in duplicate, an accurate timepiece, and decompression tables or charts.
- (43) The instrument panel shall be adequately lighted.
- (44) The man-lock shall be fitted with valves both inside and outside the lock.
- (45) The valves to which the airlock attendant has no access shall be sealed in a box provided with a glass panel that can be broken to permit the use of the valves in case of emergency.
- (46) Except in cases of emergency valves shall be operated only by the airlock attendant.

*Regulation of temperature in airlock*

- (47) The temperature in every airlock shall be regulated as required by heating or by protection against loss of heat, or by protection against the direct rays of the sun by means of a covering that can be sprayed with water.

*Communication*

- (48) The working chamber and the airlock shall be in telephonic communication at all times with the airlock attendant, who shall also be provided with telephonic or other satisfactory means of communicating with the contractor or his or her representative on the works.
- (49) The contractor shall depute a representative to be at all times available for communication with the airlock attendant.
- (50) In the event of telephone failure, signals shall be transmitted by tapping.
- (51) A suitable code of signals shall be formulated on the job and a copy of this code shall be posted inside and outside the man-lock.

*Height of working chamber*

- (52) The height of the working chamber, measured between the roof and the lower cutting edge, shall be at least 8 feet.

*Medical lock*

- (53) A medical lock at least 5 feet in diameter shall be provided when work is being carried out at a pressure of 25 pounds per square inch or over.
- (54) Should any case of compressed air illness occur when the working pressure is less than 25 pounds per square inch it may be dealt with in the man-lock.



- 
- (55) The medical lock shall have 2 compartments, so that entry may be obtained to the inner chamber while it is under pressure.
  - (56) The medical lock shall be adequately ventilated, protected from the direct rays of the sun or adequately heated if required, and it shall be adequately lighted.
  - (57) The lock and its equipment shall be kept in a clean state.
  - (58) The medical lock shall be provided with suitable equipment, including a couch not less than 6 feet in length, clean blankets, dry woollen garments, a food lock and a telephone.
  - (59) The medical lock shall be located within the immediate vicinity of the works and arrangements shall be made to ensure that the lock is ready for operation during the 12 hours after the end of any shift.
  - (60) The medical lock shall be equipped with a small glazed aperture so that a patient under treatment in the lock can be kept under observation by the attendant from outside the lock.
  - (61) It shall be provided with a pressure gauge and an accurate timepiece for each compartment.
  - (62) The timepiece and pressure gauge for the main compartment shall be in such a position that they can be readily seen by the attendant whether the attendant is inside or outside the lock.

### *Lighting*

- (63) All lighting in compressed air chambers shall be by electricity only, except in case of emergency.
- (64) One man in an airlock shall be provided with an electric pocket lamp, and candles and damp-proof matches shall be provided in the working chamber and in each airlock.
- (65) All portable incandescent lamps shall be guarded by a wire cage large enough to enclose both lamp and socket.

- (66) The lamps shall be constructed in accordance with the provisions of Standards Australia, Approval and Test Specification No C. 118, entitled Electric Hand-Lamps.

*Electric installation—voltage*

- (67) The voltage used for electrical apparatus and lights in compressed air chambers shall not exceed 32V for alternating current supply and 50V for direct current supply.

*Electric installation—wiring*

- (68) Except as otherwise provided in this regulation, all wiring for light and power circuits shall comply with the requirements of the Standards Australia Wiring Rules for damp or hazardous locations.

*Air supply*

- (69) A minimum of 25 cubic feet of clean fresh air shall be supplied per minute to each worker in the working chamber, and a minimum of 10 cubic feet per minute to each worker in the man-lock.
- (70) In the event of a failure of the air supply exceeding 5 minutes in duration, all workers shall be withdrawn from the working chamber.

*Free air intake*

- (71) The free air intake shall be so situated as to ensure an ample supply of clean, fresh air.
- (72) Care shall be taken to avoid contamination of the air by fumes from the exhausts of compression ignition and internal-combustion engines and from all other sources.

---

*Purification and refrigeration of compressed air*

- (73) An approved oil separator shall be used between the compressor and the air receiver and an approved air filter shall be placed between the air receiver and the working chamber.
- (74) The air shall be cooled after compression, if necessary, to ensure that the temperature in the working chamber does not exceed 80° Fahrenheit when measured with a dry bulb thermometer.

*Compressed air plant*

- (75) If the air compressor, used for supplying air under pressure for the purposes of compressed air work in caissons is driven by electric power, stand-by compressor plant shall be provided and shall be of the capacity that in the event of failure of the electrically-driven units at least 50% of the air supply may be maintained.
- (76) With other than electrically-powered compressors not more than 50% of the compressor units shall be driven from any 1 power unit and, if practicable, the power units shall be interchangeable.

*Air lines and fittings*

- (77) Each air line shall be equipped with the following fittings connected in the following order:
  - (a) an air receiver of such capacity as to be capable of delivering at least 50 cubic feet of air to the working chamber at normal working pressure, for the purpose of reserve storage in the event of failure of the compressor plant;
  - (b) a stop valve;
  - (c) a pressure-reducing valve located close to the man-lock;
  - (d) a non-return valve located close to the man-lock.

- (78) The air supply shall be through duplicate air lines between the air receiver and the working chamber.
- (79) An adjustable safety valve shall be fitted on the outside of the airlock, exhausting to the outside air.

*Testing of equipment—general*

- (80) All airlocks, shafts and air receivers shall be subjected to test in accordance with the provisions of the Australian Standard Rules recommended for the Design, Construction, Inspection and Operation of Boilers and Unfired Pressure Vessels and their Appurtenances published by Standards Australia as revised in May, 1942.

*Testing of equipment—pressure gauges*

- (81) Pressure gauges shall be installed and tested in accordance with the relevant provisions of the rules mentioned in subsection (80).

*Change rooms*

- (82) Without prejudice to the requirements of part 10 (which among other things relates to the provision of certain accommodation for the health of persons) there shall be provided and maintained for the use of persons employed in compressed air work in caissons—
- (a) properly heated, lighted and ventilated change rooms and drying rooms; and
  - (b) bathing accommodation, namely 1 shower equipped with running hot and cold water for every 8 men employed on the same shift and 1 for every 8 women employed on the same shift, and 1 for any number less than 8 such men or women, as the case requires; and

- (c) suitable and adequate earth or water closets at the rate of 1 closet for every 10 men employed on the same shift and 1 for every 10 women employed on the same shift, and 1 for any number less than 10 such men or women, as the case requires.

*Information to be posted in change room*

- (83) A copy of the following information shall be posted in the change room for the information and instruction of persons engaged in compressed air work in caissons:
  - (a) schedule 9, concerning the Symptoms and Treatment of Compressed Air Illness;
  - (b) section 101 (12) to (17);
  - (c) the name, address and telephone number of the medical officer.

*Prohibition of smoking and intoxicating liquor*

- (84) No person shall smoke in a man-lock or working chamber.
- (85) No person shall carry smoking materials into a man-lock or into a working chamber.
- (86) All such smoking materials shall be left in the change room.
- (87) No person shall bring any intoxicating liquor into the vicinity of the working chamber, provided that the carrying of alcoholic spirits or other stimulants into such places for medical purposes may be approved by the medical officer.

*Regulation to be available*

- (88) A copy of this section shall be kept on the works so as to be easily accessible to all persons who are responsible for giving effect to its provisions.

**Part 8** Safeguards and measures to be taken for securing the safety and health of persons engaged in compressed air work  
**Division 8.3** Caissons

Section 101

---

(89) This section shall apply to compressed air work in caissons, being a compressed air work within the meaning of the Act.

## Part 9A Explosive-powered tools—safety measures

### Application and interpretation

#### 118A

- (1) This part shall apply to and in relation to the use of explosive-powered tools in building work, excavation work and compressed air work.
- (2) In this part:

*explosive-powered tool* means a tool by which a projectile may be driven against, into or through any substance by means of an explosive, and includes every attachment to and accessory of the tool and every device used or adopted or intended to be used with it.

*projectile* means stud, pin, dowel screw, rivet, spike or other object driven against, into or through any substance by means of an explosive-powered tool, or adapted or intended to be so driven.

*qualified operator* means a person who—

- (a) is over 18 years old; and
- (b) has been thoroughly trained in the correct use, adjustment, assembly and taking apart of explosive-powered tools; and
- (c) has been fully instructed about the dangers associated with explosive-powered tools and the precautions to be taken in relation to them; and
- (d) has a thorough knowledge of this part.

*tool* means explosive-powered tool.

*work* means building work, excavation work or compressed air work.

- (3) For this part, a person shall be deemed to use an explosive-powered tool if the person loads, unloads or fires, or attempts to load, unload or fire, the tool.

## **Operators of explosive-powered tools**

### **118B**

#### *Operators to be qualified*

- (1) No person who is not a qualified operator shall use a tool in any work.
- (2) No person shall employ, instruct or allow any person to use a tool in any work without first ensuring by proper inquiry that the person is a qualified operator and is not because of any infirmity, disability or incapacity unfit to use the tool.

#### *Training of operators*

- (3) Nothing in subsection (1) or (2) shall apply to the use of any explosive-powered tool by a person who, under the immediate supervision and control of a qualified operator, is being trained to be a qualified operator.

## **General requirements for explosive-powered tools and projectiles**

### **118C**

- (1) No person who directly or by his or her servants or agents carries out any work shall directly or by his or her servants or agents—
- (a) use in that work any tool unless—
- (i) the tool has been approved; and
- (ii) there is permanently engraved or embossed on the metal of the tool a clearly legible notice as follows: ‘DO NOT



REMOVE TOOL FROM WORK SURFACE FOR AT LEAST 10 SECONDS IF TOOL FAILS TO FIRE'; and

- (iii) there is permanently engraved or embossed on the metal of the tool a clearly legible serial number by which it can be readily identified; and
  - (iv) there is permanently attached to the tool at its muzzle end a protective shield or device designed to arrest the ricochet of projectiles and the free flight of other objects and particles liberated by the firing of the tool; and
- (b) use in that work, in a tool, any projectile that is not capable of undergoing the following test without cracking or breaking:
- (i) smooth shanked projectiles shall be bent through an angle of 60°;
  - (ii) knurled shanked projectiles shall be bent through an angle of 30°.
- (2) The test shall be carried out by bending the shank of the projectile about a pin of a diameter equal to that of the shank of the projectile under test.
- (3) The test shall be made by applying a continuous steady load to the projectile until the required deformation has been reached.

## Inspection and repair of explosive-powered tools

### 118D

#### *Interpretation*

- (1) In this section:
- authorised person*** means—
- (a) a maker of tools or a person authorised by the maker to repair tools; or

- (b) a gunsmith; or
- (c) a competent person in the employment of a person referred to in paragraph (a) or (b).

**defect** means any defect that might impair or affect the safe and normal operation of a tool.

**repair** means repair, modify, alter or adjust or attempt to repair, modify, alter or adjust; but a qualified operator or a person who under the immediate supervision and control of a qualified operator is being trained to be a qualified operator shall not be deemed to repair a tool only because of his or her making or attempting to make any minor adjustments to it that are incidental to its ordinary operation.

### *Inspection*

- (2) The person who directly or by his or her servants or agents carries out any building work—
  - (a) shall cause each tool used in the work—
    - (i) to be carefully inspected for defects on each day when it is so used, before it is so used; and
    - (ii) after each 7 days use and before it is again used in any work, to be dismantled and thoroughly examined for defects; and
  - (b) shall not directly or by his or her servants or agents use in the work a tool that—
    - (i) has not been inspected and examined as prescribed by paragraph (a); or
    - (ii) has any defect that has been or should have been revealed on the inspection or examination.
- (3) No person shall, knowing that a tool has any defect, use the tool in any work.

*Repair*

- (4) No person other than an authorised person shall, knowing that a tool is being used or is intended to be used in work, repair the tool.
- (5) No person shall—
  - (a) knowing that a tool is being used or is intended to be used in work, employ, instruct or allow any person other than an authorised person to repair the tool; or
  - (b) knowing that a tool has been repaired by a person other than an authorised person, use the tool in any work or employ, instruct or allow any person to use the tool in any work, unless it has since been overhauled by an authorised person.

**Use of explosive-powered tools****118E***General*

- (1) No person shall use in any work, or employ, instruct or allow any person to use in any work, any tool or other substance or thing contrary to this section, or without the measures and precautions prescribed by this section being taken.

*Limitation of use—hard substances*

- (2) No tool shall be used on high tensile steel, steel hardened by heat treatment, cast iron or other unusually hard or unyielding substance.
- (3) In subsection (2):

***high tensile steel*** means steel the nominal ultimate tensile value of which exceeds 45 tons per square inch.

*Readily shattered substances*

- (4) No tool shall be used on hard tile, hard terracotta, glazed brick, glass, marble, granite, thin slate or other readily shattered substance.

*Use near edges and holes*

- (5) No tool shall be used to drive a projectile into any substance—
- (a) at a point so close to an edge of the substance or to any hole in it that, because of the nature of the substance, the size and shape of the projectile or the strength of the charge to be used, there is any appreciable risk that the substance might crack or break or the projectile fly from it; or
  - (b) if the substance is steel—within  $\frac{1}{2}$  an inch of an edge of it; or
  - (c) if the substance is brick, concrete or the like—within 3 inches of an edge of it.

*Explosive or dangerous atmosphere*

- (6) No tool shall be used in the presence of an explosive or inflammable gas, dust or vapour, or in compressed air, or in any place where the explosive charge might be exploded or rendered dangerous by heat.

*Strength of explosive charges*

- (7) Every reasonable precaution, including if advisable the making of suitable tests, shall be taken to ensure that the explosive charge used in a tool—
- (a) is of no greater strength than is necessary for the purpose for which the tool is being used; and
  - (b) is not of such strength that the whole of the projectile might pass through the substance on which the tool is being used, unless the substance is backed by protective material capable of fully absorbing the energy of the projectile.

*Use of barrel extensions*

- (8) If the muzzle end of the barrel of a tool cannot be brought into contact with any surface at the point where the projectile driven from the tool is to strike or penetrate the surface, an effective barrel extension shall be used to extend the barrel into contact with the surface at that point.
- (9) The length of the barrel extension shall not exceed by more than  $\frac{1}{2}$  an inch the maximum length that is required to clear the obstruction that renders the use of the barrel extension necessary.

*Care in handling of tools*

- (10) Every person while using a tool or carrying or handling a loaded tool shall at all times—
  - (a) keep all parts of his or her body clear of the open end of the barrel of the tool and keep the end pointed away from himself or herself and all other persons; and
  - (b) exercise the utmost care to avoid injury to himself or herself and others.

*Firing of tools*

- (11) No person shall fire a tool unless—
  - (a) the person is in a safe, well-balanced position so that inadvertent tilting or misalignment of the tool at the time of firing will not occur; and
  - (b) the person is holding the tool perpendicular to the surface on which the person is using the tool and so that the muzzle end of its barrel or barrel extension is in contact with that surface.

*Mechanical failure*

- (12) If when any person attempts to use a tool on any surface the tool fails to fire, the person shall continue to hold it perpendicular to and in

contact with the surface for at least 10 seconds, and if the tool has not then fired the person shall unload it or place it in such a position that it will do no harm if it fires.

*Removing foreign matter*

- (13) A person using a tool shall, after each firing, carefully examine it and remove from it all pieces of projectile or cartridge and other foreign matter that may be present.

*Flying projectiles*

- (14) No person shall intentionally fire a tool in such a way as to cause the projectile to fly free.

*Use of suitable equipment*

- (15) There shall not be used in or with any tool any projectile, explosive charge, breech plug, barrel extension or adaptor that is not of a type correctly suited to the particular tool and to the purpose for which the tool is being used.
- (16) No tool shall be used for a purpose for which it is not properly adapted.

*Manufacturer's recommendations*

- (17) If there appears on the container of any tool or in any printed matter supplied with any tool any instruction, advice or recommendation, not inconsistent with this regulation, about the safe use of the tool or the use with it, for reasons of safety, of any substance or thing, the tool, substance or thing shall be used in accordance with the instruction, advice or recommendation.
- (18) Subsection (17) does not require the use of any particular brand or make of any substance or thing.

## Care and storage of explosive-powered tools and cartridges

### 118F

#### *Container for tools*

- (1) The person who directly or by his or her servants or agents carries out any work in which any explosive-powered tool is used shall keep or cause to be kept each such tool, at all times when it is not required to be removed for use, inspection, repair or other necessary purpose, in the container supplied by the maker of the tool or in an equally suitable container.
- (2) No person shall take or keep any explosive-powered tool out of its container unless the tool is for the time being required for use, inspection, repair or other necessary purpose.

#### *Safekeeping of tools*

- (3) No person shall leave unattended on the site of any work, or any cartridge intended for use in a tool, unless effective precautions are taken to ensure that it will not be taken away, handled or used by unauthorised persons.

#### *Loaded tools*

- (4) No person shall, elsewhere than at the place where the tool is to be used, load any tool for use in any work.
- (5) No person shall in the course of any work carry or transport a loaded tool from place to place, unless because of mechanical failure the tool cannot be unloaded.

#### *Cartridges*

- (6) The person who directly or by his or her servants or agents carries out any work in which a tool is used shall ensure that the cartridges for

all such tools are kept in a metal container or metal containers, and shall ensure that each such container—

- (a) is kept clearly marked with the word ‘EXPLOSIVE’; and
- (b) is kept locked at all times except when cartridges are being placed in it or removed from it; and
- (c) is not, while it is on the site of the work, opened except by a person using a tool or assisting in the use of a tool; and
- (d) contains nothing except cartridges.

## **Protective devices**

### **118G**

- (1) The contractor shall provide, for the use of each person employed by the contractor in any work who in the work uses or assists in the use of an explosive-powered tool, an effective device of an approved type for the protection of the eyes of the person from missiles and flying particles.
- (2) The device so provided for the use of any person shall not be one that has been used by any other person, unless it is of metal, plastic or other non-absorbent material and has been thoroughly cleaned.
- (3) No person for whose use such a device has been provided in accordance with this section shall in the work use or assist in the use of any tool unless the person is using that device.

## **Warning notices**

### **118H**

At all times when an explosive-powered tool is being used in any work, the person who directly or by his or her servants or agents is carrying out that work shall cause to be displayed on the site of the work, so as to be clearly legible by all persons who are at or near the place where the tool is being used, a notice or notices as follows:



'Warning—Explosive-Powered Tool In Use'.

**Part 10** Measures to be taken for securing the health of persons in building work, excavation work and compressed air work by provision of first-aid equipment, shelter, change and dining accommodation, sanitary conveniences and washing facilities

**Division 10.1** First-aid equipment

Section 119

---

**Part 10** **Measures to be taken for securing the health of persons in building work, excavation work and compressed air work by provision of first-aid equipment, shelter, change and dining accommodation, sanitary conveniences and washing facilities**

**Division 10.1** **First-aid equipment**

**119**

- (1) On every building work, excavation work or compressed air work where not more than 25 persons are employed, there shall be provided a first-aid chest that shall be equipped and maintained to contain at least the following requisites and appliances, unless otherwise approved:

<b>items</b>	<b>specifications</b>
Dettol, Melasol, Zephiran, or Solyptol solutions, 4 oz	
castor oil, 1 oz	with glass rod bulged, pendant
sal volatile, 2 oz	

---

<b>items</b>	<b>specifications</b>
finger dressings (12)	To be of gauze 12 inches long × 4 inches wide, with a piece of tape 12 inches long and 1/4 inch wide, securely attached at its middle to 1 end of each dressing. Each shall be sterilised and enclosed in a sealed carton.
adhesive strapping, 1 inch (1 reel)	1st quality
cotton wool, 4 oz	to be sterile and to be enclosed in 1 oz quantities in sealed cartons
bicarbonate of soda, 2 oz	to be sterile and enclosed in 1 oz quantities in sealed cartons
boracic acid, 2 oz	to be sterile and enclosed in 1 oz quantities in sealed cartons
plain gauze, 1 yard	enclosed in a sealed carton
roller bandages, 1 inch (3)	to be enclosed in a sealed envelope
triangular bandages (3)	of 1st quality
tourniquet (1)	St. John's
medicine glass, 2 oz (1)	to be marked for teaspoon, dessertspoon and tablespoonful doses
eye bath (1)	of 1st quality plastic
dressing forceps, 5 inch (1 pr)	
splinter forceps, 5 inch (1 pr)	
scissors, 5 inch (1 pr)	

---

**Part 10** Measures to be taken for securing the health of persons in building work, excavation work and compressed air work by provision of first-aid equipment, shelter, change and dining accommodation, sanitary conveniences and washing facilities

**Division 10.1** First-aid equipment

Section 119

---

<b>items</b>	<b>specifications</b>
towels (1)	of 1st quality
enamel basin, 7 <sup>1</sup> / <sub>2</sub> inches diam. (1)	of 1st quality
safety pins (12)	of 1st quality
enamel drinking mug (1)	of 1st quality
first-aid pamphlet (1)	Departmental 'First-aid in Industry'.

- (2) On every building work, excavation work or compressed air work where more than 25 and not more than 100 persons are employed, there shall be provided a first-aid chest that shall be equipped and maintained to contain at least the following requisites and appliances unless otherwise approved:

<b>items</b>	<b>specifications</b>
Dettol, Melasol, Zephiran, or Solyptol solutions 8 oz	
castor oil, 1 oz	with glass rod bulged, pendant
sal volatile, 4 oz	
finger dressings (24)	To be of gauze 12 inches long × 4 inches wide, with a piece of tape 12 inches long and <sup>1</sup> / <sub>4</sub> inch wide, securely attached at its middle to 1 end of each dressing. Each shall be sterilised and enclosed in a sealed carton.
adhesive strapping, 1 inch (2 reels)	1st quality

Measures to be taken for securing the health of persons in building work,  
excavation work and compressed air work by provision of first-aid  
equipment, shelter, change and dining accommodation, sanitary  
conveniences and washing facilities  
First-aid equipment

**Part 10**

**Division 10.1**

Section 119

---

<b>items</b>	<b>specifications</b>
cotton wool, 8 oz	to be sterile and enclosed in 1 oz quantities in sealed cartons
bicarbonate of soda, 4 oz	to be sterile and enclosed in 1 oz quantities in sealed cartons
boracic acid, 4 oz	to be sterile and enclosed in 1 oz quantities in sealed cartons
plain gauze (2 yds)	in yard quantities each enclosed in a sealed carton
roller bandages, 1 inch (6)	to be enclosed in a sealed envelope
roller bandages, 2 inch (6)	to be enclosed in a sealed envelope
triangular bandages (4)	of 1st quality
tourniquet (1)	St. John's
medicine glass, 2 oz (1)	to be marked for teaspoon, dessertspoon and tablespoonful doses
enamel feeding cup (1)	of 1st quality
eye bath (1)	of 1st quality plastic
dressing forceps, 5 inches (1 pr)	
splinter forceps, 5 inches (1 pr)	
scissors 5 inches (1 pr)	
towels (2)	of 1st quality
enamel basin, 9 inches diam. (1)	of 1st quality
safety pins (12)	of 1st quality

---

**Part 10** Measures to be taken for securing the health of persons in building work, excavation work and compressed air work by provision of first-aid equipment, shelter, change and dining accommodation, sanitary conveniences and washing facilities

**Division 10.1** First-aid equipment

Section 119

---

items	specifications
enamel drinking mug (1)	of 1st quality
first-aid pamphlet (1)	Departmental 'First-aid in Industry'.

(3) On every building work, excavation work or compressed air work where more than 100 persons are employed there shall be provided a first-aid chest that shall be equipped and maintained to contain at least the following requisites and appliances unless otherwise approved:

items	specifications
Dettol, Melasol, Zephiran, or Solyptol solutions, 12 oz	
castor oil, 2 oz	with glass rod bulged, pendant
sal volatile, 6 oz	
finger dressings (48)	To be of gauze 12 inches long × 4 inches wide, with a piece of tape 12 inches long and 1/4 inch wide, securely attached at its middle to 1 end of each dressing. Each shall be sterilised and enclosed in a sealed carton.
adhesive strapping, 2 inches (2 reels)	1st quality
cotton wool, 1 lb	to be sterile and to be enclosed in 1 oz quantities in sealed cartons
bicarbonate of soda, 8 oz	to be sterile and enclosed in 1 oz quantities in sealed cartons

Measures to be taken for securing the health of persons in building work,  
excavation work and compressed air work by provision of first-aid  
equipment, shelter, change and dining accommodation, sanitary  
conveniences and washing facilities  
First-aid equipment

**Part 10**

**Division 10.1**

Section 119

---

<b>items</b>	<b>specifications</b>
boracic acid, 4 oz	to be sterile and to be enclosed in 1 oz quantities in sealed cartons
plain gauze, 4 yards	in yard quantities each enclosed in a sealed carton
roller bandages, 1 inch (12)	to be enclosed in a sealed envelope
roller bandages, 2 inches (8)	to be enclosed in a sealed envelope
triangular bandages (6)	of 1st quality
tourniquet (1)	St. John's
medicine glasses, 2 oz (2)	to be marked for teaspoon, dessertspoon and tablespoonful doses
enamel feeding cup (1)	of 1st quality
eye bath (1)	of 1st quality plastic
dressing forceps, 5 inches (1 pr)	
splinter forceps, 5 inches (1 pr)	
scissors, 5 inches (1 pr)	
towels (3)	of 1st quality
enamel basin, 15 inches diam. (1)	of 1st quality
safety pins (36)	of 1st quality
enamel drinking mug (1)	of 1st quality
first-aid pamphlet (1)	Departmental 'First-aid in Industry'.

**Part 10** Measures to be taken for securing the health of persons in building work, excavation work and compressed air work by provision of first-aid equipment, shelter, change and dining accommodation, sanitary conveniences and washing facilities

**Division 10.1** First-aid equipment

Section 119

---

- (4) First-aid chests provided for this section may be constructed of wood or metal, but each chest so provided and constructed shall be dustproof, fitted with a lock and key, and shall be distinctively marked with a white cross on a green ground.
- (5) First-aid chests shall properly accommodate their contents.
- (6) Nothing except requisites or appliances for first-aid shall be kept in the first-aid chest, which shall always be readily accessible.
- (7) If not more than 100 persons are employed, the first-aid chest shall be fitted with a carrying handle and so constructed and maintained that it can be easily carried from job to job.
- (8) The first-aid chest shall normally be kept in the change room.
- (9) If more than 100 persons are employed, a first-aid post shall be provided in a room set aside for the purpose and equipped with facilities for washing and for boiling water, and with a couch, blankets, a portable stretcher and also a first-aid chest as previously detailed.
- (10) Each first-aid chest and first-aid post shall be placed under the charge of a responsible person or persons, who or 1 of whom shall always be readily available during working hours.
- (11) The person or persons shall, if practicable, be the holder of a St. John's Ambulance Medallion with current label.
- (12) A notice shall be prominently attached in every change room and first-aid post where the first-aid chest is normally kept.
- (13) This notice shall clearly state the name or names of the person or persons in charge of the first-aid chest.



---

## Division 10.2 Shelter, change and dining accommodation

### 120

- (1) In this section:

**work** means building work, compressed air work or excavation work.

*General—accommodation to be provided*

- (2) Immediately on beginning a work, suitable and adequate accommodation where persons employed can keep their clothes and personal belongings safe from damage and theft, eat their meals and shelter from the weather, shall be provided on the site.

*General—shelter shed on small works*

- (3) On works where less than 10 workers are employed at any one time a small shed of such dimensions as to provide not less than 10 square feet of floor area per person will meet the requirements of subsection (2).
- (4) This shed may also be used for the storage of the workers's tools but shall not be used for the storage of building material.
- (5) When part of a building in course of construction has been made weatherproof and secure it may be made available to employees for the purposes of this section.
- (6) On works where more than 10 workers are employed at any one time a shed or sheds shall be provided exclusively for the use of the workers.
- (7) Each shed or sheds shall be of such dimensions as to provide in the aggregate not less than 10 square feet of floor area for every worker employed on the work at any one time.

**Part 10** Measures to be taken for securing the health of persons in building work, excavation work and compressed air work by provision of first-aid equipment, shelter, change and dining accommodation, sanitary conveniences and washing facilities  
**Division 10.2** Shelter, change and dining accommodation  
Section 120

---

- (8) Any one shed shall not be used for the accommodation of more than 50 persons.
- (9) All sheds shall be absolutely weatherproof, soundly constructed with a sufficient number of openable windows, shall be floored and shall be adequately ventilated and lighted.
- (10) Every shed shall be kept clean and brooms, mops, buckets and cleaning compounds shall be provided for the purpose.

*Facilities to be provided in change and shelter sheds—hat and coat hooks*

- (11) Hat and coat hooks spaced not less than 18 inches apart for hanging clothes shall be provided in each change shed.

*Facilities to be provided in change and shelter sheds—seating accommodation*

- (12) Seating accommodation shall be provided in each change shed for the use of workers when changing boots and when sheltering from the rain.
- (13) A bench not less than 16 inches wide and of such length as to provide not less than 18 inches for each worker will meet the requirements of subsection (12).

*Facilities to be provided in change and shelter sheds—heating*

- (14) In wet or cold weather reasonable heating facilities, such as a portable coke stove with flue exhausting outside the shed, a kerosene heater, or electric radiator, shall be provided in every shelter and change shed for warmth and for drying clothes.

*Facilities to be provided in change and shelter sheds—safekeeping of employees’ tool kits*

- (15) Provision for the safekeeping of employees’ tool kits when employees are not on the work shall be made.
- (16) On works where less than 10 workers are employed at any one time this may be achieved by means of substantially constructed locked chests in the supervisor’s office or by provision of suitable accommodation in the change shed.
- (17) On works where more than 10 workers are employed at any one time special storerooms equipped with racks shall be provided.

*Dining facilities—tables and seating*

- (18) Adequate table and seating accommodation, in the proportion of not less than 22 inches run for each employee for use at meal period shall be provided in the change shed, or in a separate shed, provided that the accommodation need be provided only in relation to employees remaining on the site during meal period.

*Dining facilities—storage of food*

- (19) Hygienic provision, such as a fly-proof ventilated cupboard fitted with shelves, shall be provided for storing employees’ food.

*Dining facilities—supply of boiling water*

- (20) An ample supply of boiling water for tea making and for washing utensils shall be provided.

*Dining facilities— provision of garbage tins*

- (21) Garbage tins that are both rat-proof and fly-proof shall be provided and they shall be emptied each day.

**Part 10** Measures to be taken for securing the health of persons in building work, excavation work and compressed air work by provision of first-aid equipment, shelter, change and dining accommodation, sanitary conveniences and washing facilities

**Division 10.3** Sanitary conveniences and washing facilities

Section 121

---

*Dining facilities—drinking water*

- (22) An adequate supply of clean, cool and wholesome drinking water shall be provided on the site.

**Division 10.3 Sanitary conveniences and washing facilities**

**121**

*Meaning of work*

- (1) In this section:

*work* means, building work, excavation work, or compressed air work.

*Number to be provided*

- (2) One closet shall be provided on every work where not more than 10 men employed at the one time and 1 for every 10 women employed at the one time, and 1 for any number less than 10 such men or women, as the case requires.

*Location*

- (3) The closet accommodation shall be located so as to be readily accessible from the place where men or women are working, but shall be far enough removed to avoid nuisance.

*Construction*

- (4) All closets shall be soundly constructed and roofed with weatherproof material.

- (5) The floor of each closet shall be well drained and constructed of concrete, bricks and cement or of other approved material that shall be impervious to water.
- (6) Every closet shall be well lighted by natural or artificial light and shall be well ventilated.
- (7) Each closet shall have a hinged door capable of being fastened both on the inside and on the outside.

*Closets to be kept clean*

- (8) Closets shall be maintained in a clean condition.

*Washing facilities—number of basins*

- (9) One wash basin shall be provided on every work where not more than 20 persons are employed at the one time, and 1 additional wash basin for each additional 20 persons or part of 20 persons so employed.

*Washing facilities—location*

- (10) Washing facilities shall be located under cover and conveniently close to the change shed.

*Washing facilities—water supply*

- (11) Clean cold and hot water and soap shall be provided on every work.
- (12) Cold water shall be readily available in sufficient quantities from a cock close to the wash basins.
- (13) Hot water may be supplied from the same source as that used for tea making.

**Part 10** Measures to be taken for securing the health of persons in building work, excavation work and compressed air work by provision of first-aid equipment, shelter, change and dining accommodation, sanitary conveniences and washing facilities

**Division 10.3** Sanitary conveniences and washing facilities

Section 121

---

*Washing facilities—drainage*

(14) Drainage shall be provided for the disposal of waste water.

*Washing facilities—duckboards*

(15) Duckboards shall be provided underfoot if necessary or desirable.

*Washing facilities—washing facilities to be kept clean*

(16) Washing facilities shall be kept clean.

**Part 11**                      **Basic requirements about design  
and construction, erection, use,  
maintenance, inspection and  
testing with particular reference  
to cranes, lifts, hoists,  
scaffolding and plant**

**122**

- (1) Every crane, lift, hoist, plant, scaffolding, and all gear shall be so designed, constructed and maintained that after taking into full account the magnitude, incidence, conditions, and way of all loadings and forces, the proportioning of each member, component, part and attachment of it or to it is such that the maximum stress imposed or developed in it is less than 75% of the minimum stress liable by repetition or otherwise to impair its elastic properties.
- (2) Every member, component, part and attachment shall be robust and so proportioned that it functions without excessive elastic action, deflection, vibration, movement, or distortion and without undue or untimely deterioration.
- (3) Subsections (1) and (2) shall not be construed as allowing any greater stress or deflection, or any less provision in relation to wind loads, sideloads or dynamic effects than may be more specifically prescribed in this regulation.
- (4) Unless more specifically prescribed elsewhere in this regulation, the minimum stress liable by repetition or otherwise to impair the elastic properties of a material shall be deemed equal to the least of the following stresses:

**Part 11** Basic requirements about design and construction, erection, use, maintenance, inspection and testing with particular reference to cranes, lifts, hoists, scaffolding and plant

Section 122

---

- (a) the  $\frac{1}{10}$  of 1% proof stress for such material when tested in a way productive of the same type and character of stress as that under consideration (namely, tensile, compressive or shearing stress); or
  - (b) the stress applied as an average stress by an approved authority during endurance tests, plus  $\frac{1}{2}$  of the endurance range, coincident to it, as determined by the authority on a 10 million cycle basis, provided that the stress thus determined is of the same type and character as that under consideration (namely, transverse, tensile, compressive or shearing stress) and that, unless the chief inspector specifically approves otherwise, the average stress shall be assumed to be zero.
- (5) If it can be estimated with reasonable certainty that the stress cannot be imposed or developed in whole or in part more than 2 million times during the working life of the material, the stress prescribed by subsection (4) (b) may be disregarded.
- (6) If a material is subject to solely transverse or torsional stress (or both), and if the  $\frac{1}{10}$  of 1% proof stress is less than  $\frac{1}{2}$  of the endurance range mentioned in subsection (4), the stress prescribed by subsection (4) (a) may be disregarded.
- (7) For the purpose of estimating the numbers of stress repetitions to which any member, component, part or attachment of any crane, lift, hoist, scaffolding, plant or gear is liable, the working life of the crane, lift, hoist, scaffolding, plant or gear shall, unless the chief inspector otherwise approves, be deemed to be at least 80 thousand hours.
- (8) Except as may be otherwise prescribed in this regulation—
- (a) every crane or hoist and the parts of it and all gear shall be classified numerically in conformity with the following table, according to its working period, effective load and the dynamic effects to which it is subjected taking into consideration all of the circumstances and conditions under which it is to work and



- to which it is to be exposed, as also all of the functions it is to perform, and, in the event of uncertainty or dispute, the classification may be determined by the chief inspector; and
- (b) every scaffolding shall be deemed to be within classification 3, except that the timbers of it may be deemed within classification 2; and
  - (c) every lift and every hoist used for raising or lowering workers shall be deemed to be within classification 4; and
  - (d) for the purpose of determining stresses in timbers, cranes and hoists and their supporting structures, they shall be deemed to be within classification 1 if indoor, and classification 2 if outdoor; and
  - (e) no person shall cause or effect any change in the circumstances or conditions under which any crane, lift, hoist, scaffolding, plant or gear is to work, or to which it is to be exposed, or in the functions it is to perform, unless after the change the classification of the crane, lift, hoist, scaffolding, plant, or gear would on reconsideration remain unaltered or revert to a numerically lower order; and
  - (f) no person shall use a crane, lift, hoist, scaffolding, plant, or gear after such change unless the classification of it would on reconsideration remain unaltered or revert to a numerically lower order; and
  - (g) nothing in this subsection shall prevent any person from designing, constructing, erecting or using a crane, lift, hoist, scaffolding, plant, or gear of greater safety, strength, and stability than that prescribed in this subsection.

**Part 11** Basic requirements about design and construction, erection, use, maintenance, inspection and testing with particular reference to cranes, lifts, hoists, scaffolding and plant

Section 122

---

**Table 122.1 Classification of cranes and hoists and gear for purposes of design, construction and use**

<b>classification</b>	<b>working period</b>	<b>effective load</b>	<b>dynamic effects</b>
1	short	low	low
2	long	low	low
	short	high	low
	short	low	high
3	long	high	low
	long	low	high
	short	high	high
4	long	high	high

- (9) In applying table 122.1 the following subsections apply.
- (10) The working period of any crane, hoist, or gear shall be considered to be short if it operates or may reasonably be expected to operate for less than 500 hours per annum, or long if it operates or may reasonably be expected to operate for more than 500 hours per annum.
- (11) The effective load of any crane, hoist or gear shall be considered to be low unless it lifts or may reasonably be expected to lift loads greater than  $\frac{2}{3}$  of its safe working load on more than 1 000 occasions per annum.
- (12) The effective load shall otherwise be considered to be high.
- (13) Dynamic effects may be considered low if the speed of travelling of both crab and crane or hoist are each less than 300 feet per minute, or 400 feet per minute if the active surfaces of the respective track rails are uninterrupted by gaps or joints.

- (14) Dynamic effects shall be considered high if the crane, hoist or gear or any part or motion of it is used for any purpose, or in any way likely to produce greater shock effects than those caused by travelling on steel track rails at the speeds mentioned in subsection (13).
- (15) Dynamic effects may be considered low for mobile cranes or mobile hoists having well-sprung road wheels and travelling at moderate speeds on surfaces not less regular than closely laid decking of sawn timber.
- (16) Road wheels having approved pneumatic balloon tyres of the 'off-the-road' type may be considered equivalent to well-sprung road wheels.
- (17) Dynamic effects shall be considered high for other mobile cranes or mobile hoists.
- (18) Reference should also be made to examples given in table 122.2 and table 122.3, in determining the classification of a crane or hoist, or gear, or part of it.
- (19) If any single crane or hoist travelling in relation to its supporting structure, does not cause the major loadings to recur principally on portions only of the supporting structure, the structure if supporting a crane or hoist within classifications 2, 3 or 4, may be deemed to be within the next lower classification to that of the crane or hoist.
- (20) However, this shall not apply to supporting structures constructed of timber.

**Part 11** Basic requirements about design and construction, erection, use, maintenance, inspection and testing with particular reference to cranes, lifts, hoists, scaffolding and plant

Section 122

---

(21) Table 122.2 is for reference in classifying crane and hoist frame and supporting structures in the respective groups shown in table 122.1.

**Table 122.2**

<b>type of crane</b>	<b>classification</b>	<b>explanatory note</b>
hand cranes (except vehicular types)	1	
conveyors (belt, tyne, slat, scraper, tray, chain, etc, but not bucket)		
engine house cranes		
cranes for occasional use only, in commission not more than 500 hours per annum		
single and twin derrick poles		
bucket conveyors	2	
*slings, yokes and general lifting gear used in medium factories and workshops for moderate work (but not used in handling hot articles, apparatus or materials, or substances or liquids injurious to human life or limb)		
tower and portal cranes and hammer-headed cranes	2	
cupola hoists for light and medium foundries		
floating cranes		
stacking machines		
overbraced or underbraced jib cranes (except blacksmiths, boilermakers, welders)		
giant cranes and fixed and travelling gantries		
ice works cranes		

type of crane	classification	explanatory note
light duty cranes in commission not more than 750 hours per annum hand cranes mounted on vehicles derrick cranes winches or hoists used in building and constructional works sheerlegs and gallows frames sprung mobile cranes (other than vehicular used in building and constructional works) shipbuilding cranes machine shop secondary cranes pile-drivers and pile-tilters monorail runway hoists	3	This classification includes the generality of cranes and hoists in commission not more than 2 500 hours per annum, and not commonly engaged in shift work, or for such arduous duties
locomotive cranes overbraced or underbraced jib cranes used in blacksmithing, boilermaking or welding, or analogous duties cupola hoists for heavy foundries cranes used for pulling piles or sheet piling overhead traveller cranes not elsewhere included magnet cranes not handling scrap derrick and other cranes having grabs, lifting magnets, or light skull breaker devices travelling gantry derrick cranes		

**Part 11** Basic requirements about design and construction, erection, use, maintenance, inspection and testing with particular reference to cranes, lifts, hoists, scaffolding and plant

Section 122

<b>type of crane</b>	<b>classification</b>	<b>explanatory note</b>
caterpillar cranes (power) vehicular cranes used in building and construction works concentrates, ore, coal or cargo-handling cranes unsprung mobile cranes <i>Note</i> See ss (13) to (17). logging cranes and logging winches back-end and front end-loaders *slings yokes and general lifting gear used in building or constructional works or on wharfs or in medium foundries fork-lift trucks		as are customary in the heavy industries. Appliances within classification 3 may be regarded as designed for normal duties.
*cranes, hoists, lifts, slings, yokes and general lifting gear used in heavy industries, and generally in commission more than 2 500 hours per annum passenger and goods lifts hoists for raising or lowering workers magnet cranes, or hoists, handling scrap skull breaker cranes (except light duty types) navvys and excavators cranes and hoists used in connection with underwater operations	4	

\* Refer also to s 143 in relation to chains, s 144 in relation to steel wire ropes, and s 147 to s 153 and s 155 in relation to terminal fittings.

- (22) Table 122.3 is for reference in classifying crane and hoist mechanisms in the respective groups prescribed in section 122 (8).
- (23) If not listed in table 122.3, the mechanism should have the same classification as the crane frame structure.

**Table 122.3**

type of crane	classification	explanatory note
	1	
electric or pneumatic hoisting blocks	2	
hand-operated chain blocks used on monorail runways, etc, but not on blacksmiths, boiler shop or welders cranes or hoists, or any analogous to it		
hand-operated chain blocks used for general purposes or with blacksmiths or boiler shop or welders cranes or hoists or any analogous to it	3	
crab mechanisms of coal and ore bridges		
mechanisms of derrick cranes		
mechanisms of vehicular cranes		
mechanisms of caterpillar cranes		
mechanisms of shipbuilding cranes		
mechanisms of hoists used in building and constructional works, including pile-drivers, etc		
hand or power winches used in connection with scaffolding		

**Part 11** Basic requirements about design and construction, erection, use, maintenance, inspection and testing with particular reference to cranes, lifts, hoists, scaffolding and plant

Section 122

---

<b>type of crane</b>	<b>classification</b>	<b>explanatory note</b>
crab or other relevant mechanisms of grab, skull breaker, or magnet cranes	4	
mechanisms of coal, ore concentrates, or cargo-handling cranes or hoists		

---

- (24) Every crane and every hoist shall have constantly maintained on it a permanent notice, prominently and legibly exhibiting all of the safe working loads of the crane or hoist, together with the information about the conditions, incidence and way in which the loads may be lifted or handled as is necessary or desirable for the safe use or manipulation of the crane or hoist.
- (25) The loads, conditions, incidences and ways shall be those determined by and in conformity with this regulation as limiting values of the loads, conditions, incidences and ways of loadings.
- (26) No other load or conditions of loading shall be marked or exhibited on the crane or hoist, unless first approved by the chief inspector.
- (27) No person shall subject, or instruct, allow, or permit any person to subject any crane, lift, hoist, scaffolding, plant or gear to a greater load, or more adverse incidence or way or condition of loading than that determined by and in conformity with this regulation as a limiting load, incidence or way or condition of loading.
- (28) However, subsection (27) does not prevent the crane, lift, hoist, scaffolding, plant or gear being tested in the presence of an inspector, in the way that the chief inspector may direct.
- (29) No person shall procure, incite, advocate, enjoin or counsel the subjection of a crane or lift or hoist or scaffolding to a greater load or more adverse incidence or condition or way of loading than that mentioned in this section or than has been directed by an inspector.



- (30) No person shall represent a crane or lift or hoist or scaffolding to be capable of lifting or handling a greater load or of sustaining a more adverse incidence or condition or way of loading than that mentioned in this section or than has been directed by an inspector.
- (31) The presence of any load in a position into which it has apparently been placed by a crane, lift or hoist shall constitute prima facie evidence that it has been lifted or handled and so placed by the crane, lift or hoist and that the crane, lift or hoist has been subjected to the load, and to whatever incidence and condition and way of loading is indicated by the position and nature of the load.
- (32) If a crane, lift, hoist or scaffolding has been overloaded by lifting or handling or attempting to lift or handle a load exceeding by more than 100% that determined by and in conformity with this regulation as a limiting load, incidence, way or condition of loading, the chief inspector may require the owner or the person in charge or apparently in charge of the crane, lift, hoist or scaffolding to immediately dismantle it in whole or in part and to clean it together with its mechanisms and gearings and to lay out the parts, members, mechanisms and gearings in a place and way convenient to the chief inspector in order that investigations may be made to ascertain if material damage has ensued.
- (33) If the chief inspector considers necessary, to assure the safety of the crane, lift, hoist or scaffolding, the chief inspector may require the owner, or the person in charge or apparently in charge of it to give the metallurgical or radiographic evidence that the chief inspector may direct.
- (34) No person shall effect or procure or cause to be effected, modifications, alterations, or repairs to or in connection with a crane, lift, hoist, scaffolding, plant or gear in such way or of such nature as to be conducive to conditions of hazard, uncertainty or danger.

**Part 11** Basic requirements about design and construction, erection, use, maintenance, inspection and testing with particular reference to cranes, lifts, hoists, scaffolding and plant

Section 122

---

- (35) No person shall effect or procure or cause to be effected modifications, renewals, alterations, changes or repairs of the following nature to or in connection with any crane, lift, hoist, scaffolding, plant or gear without first having obtained the approval of the chief inspector:
- (a) peg, dovetail or weld a tooth or teeth to any gear wheel, ratchet or other toothed wheel or clutch;
  - (b) repair any such wheel or clutch by welding or by mechanical means;
  - (c) repair or rebuild shafts, spindles, pins or axles by welding;
  - (d) weld together, members, components, parts or attachments metallurgically different from one another;
  - (e) repair iron castings by welding or brazing;
  - (f) subject to heat treatment any member, component, part or attachment without first establishing and recording the chemical and physical properties of it;
  - (g) subject any member, component, part or attachment to any process of heat treatment that might reasonably be expected to affect it in a deleterious, uncertain or hazardous way;
  - (h) reforge any forged or rolled or drawn metal member, component, part or attachment that has become noticeably bent, distorted or cracked;
  - (i) renew, replace or substantially alter or interchange or exchange for another, any main structural member of a crane;
  - (j) renew, replace or substantially alter or interchange or exchange for another the machinery, mechanism or gearing of any crane.

- (36) However, subsection (35) shall not apply if complete failure of the member, component, or part concerned would not be dangerous or conducive to danger to life or limb.
- (37) Every crane and every hoist shall have constantly maintained on it a permanent brand, plainly and legibly exhibiting the classification of the crane or hoist, determined as prescribed by this regulation, and the brand shall be stamped, engraved, or welded on the crane or hoist at its main driving station.
- (38) No person shall falsely brand any crane or hoist as mentioned in subsection (37), or alter or remove any brand except with the approval of the chief inspector.

## Wind loads

### 123

- (1) If cranes or lifts or scaffolding are exposed either in whole or in part to wind loadings they shall have additional strength, stability, and fixity with which to resist the loadings.
- (2) Wind loadings shall be deemed to act normally to resistant surfaces, and to consist of a positive pressure on the windward and a negative pressure on the leeward side of the resistant structure or member.
- (3) The wind load acting on any resistant body shall be determined from the formula—

$$P = cp .$$

- (4) In subsection (3):

**P** means the force exerted in pounds per square foot of area of the body as projected on a vertical plane normal to the direction of the wind.

**Part 11** Basic requirements about design and construction, erection, use, maintenance, inspection and testing with particular reference to cranes, lifts, hoists, scaffolding and plant

Section 123

*c* means a coefficient selected table 123.1, and appropriate to the form and nature of the resistant body.

- (5) The value of *p* shall be 16 for bodies between ground level and a height of 60 feet above ground level, 22 for bodies between 60 and 300 feet above ground level, and 25 for bodies at greater heights; provided that water level shall, for floating cranes, floating hoist, or floating scaffolding, be deemed to be ground level.
- (6) If a resistant body is partially sheltered from wind by effective permanent protection, the chief inspector may determine and fix any lesser value for *p* that the chief inspector considers appropriate.
- (7) The value of *p* shall be taken at not less than 5 during that period in which an exposed crane or hoist or scaffolding is lifting or handling its safe working load, provided that if a crane or hoist is sheltered by its own supporting structure *p* shall, in relation to the supporting structure, take the value assigned in this section.

**Table 123.1 Coefficient of resistance to wind as dependent on shape or form of resistant body or surface**

type of body or surface	coefficient of resistance, 'c' for—		
	windward surface	leeward surface	total
sheds or simple buildings, or simple prismatic bodies	0.8	0.4	1.2
solid web girders	..	..	1.6
plane surfaces normal to direction of wind, or at an angle not greater than 20° to direction of wind	0.66	0.54	1.2
<i>Note</i> See also s 123.			
cylindrical bodies	..	..	0.66
sphere	..	..	0.44

type of body or surface	coefficient of resistance, 'c' for—		
	windward surface	leeward surface	total
lattice girders	..	..	0.96
concave surface	..	..	1.6
wedge with base to wind and vertex angle of 90°	..	..	1.0
wedge with point to wind and vertex angle of 90°	..	..	0.75

- (8) The wind load acting normally to sloping surfaces, such as roofs of crane or hoist supporting structures, or roofs of cabins, or machinery houses of cranes or hoists shall be determined from the formula—

$$R = np.$$

- (9) In subsection (8):

**R** means the force exerted in pounds per square foot of sloping surface.

**p** has the value assigned by subsection (5).

**n** is a coefficient selected from table 123.2, and appropriate to the slope of the surface.

Table 123.2

slope of roof in degrees, measured from the horizontal	coefficient 'n'	
	windward slope, or windward half if flat roof	leeward slope or leeward half if flat roof
0	—0.1	} —0.5
22	—0.25	
30	0	

**Part 11** Basic requirements about design and construction, erection, use, maintenance, inspection and testing with particular reference to cranes, lifts, hoists, scaffolding and plant

Section 123

---

slope of roof in degrees, measured from the horizontal	coefficient 'n'	
	windward slope, or windward half if flat roof	leeward slope or leeward half if flat roof
45	0.25	
70 and over	0.66	—0.54

- (10) The wind loads acting on curved roof surfaces shall be taken to be the same as for sloping roof surfaces of the same rise, and shall be assumed to act radially.
- (11) For sawtooth or other multi-span roofs if the windward bay of roofing effectively shelters succeeding bays the following reductions in wind loading may be made so that stability and fixity of the structure as a whole is affected:
- (a) on the bay adjoining the windward bay—50%;
  - (b) on the next bay—75%;
  - (c) on the remaining bays—87%.
- (12) All projections above the general roof level shall be considered fully exposed to wind.
- (13) If members are so disposed that a windward member shelters a leeward member from wind forces, the forces may be considered effective on only the windward member if—
- (a) the windward member being of solid web construction is not spaced at a distance greater than its own depth from the sheltered member, or
  - (b) the windward member, being of perforated, open web or lattice construction, is not spaced at a greater distance than its own width from the sheltered member.

- (14) Parts of leeward members projecting beyond sheltering members as mentioned in subsection (13) shall be deemed fully exposed to wind force.
- (15) If the spacing of members is greater than, but not more than 3 times that mentioned in subsection (13) the wind resistant surface of the leeward member may be considered to be reduced by 40%, provided that parts of it projecting beyond sheltering members shall be deemed fully exposed to wind forces, and provided that the total reduction in surface does not exceed  $\frac{1}{2}$  of that of the windward member.

### **Horizontal forces (other than those due to wind)**

#### **124**

- (1) Full allowance shall be made for all horizontal forces including those incidental to operation of the crane or hoist, or lift, or scaffolding.
- (2) The braking force at each braked wheel, arising from deceleration of the travelling or traversing motion of any crane or hoist or lift or scaffolding or relevant part of it shall be deemed equal to  $\frac{1}{7}$  of the greatest weight borne by the wheel.
- (3) It shall be considered to act at track-rail level.
- (4) Each live load shall be assumed to set up or cause incidentally a lateral horizontal force not less in magnitude than the greatest of the following:
  - (a) 5% of the live load; or
  - (b) 120 pounds; or
  - (c) whatever more exact force may be determined by approved methods.

**Part 11** Basic requirements about design and construction, erection, use, maintenance, inspection and testing with particular reference to cranes, lifts, hoists, scaffolding and plant

Section 125

---

- (5) It shall not be necessary to increase the horizontal force so determined in the way otherwise provided by section 125, but the force shall be assumed to act simultaneously with the live load.
- (6) Full allowance shall be made for horizontal forces due to slewing, oscillating, reciprocating, or centrifugal actions, misalignments or settlements, heeling of supporting structure, or operation on sloping, irregular or soft surfaces.
- (7) The rate of deceleration of the slewing motions of derrick or jib cranes shall be deemed to be not less than 1 foot per second, per second, measured at the jibhead, irrespective of its position.

## **Dynamic and repealed loadings**

### **125**

- (1) To make allowance for frequently repeated loadings their variable magnitudes, and the effects of shocks, all internal forces or moments caused by live loads shall be increased in the ratio shown in table 125 or as may be in this section more specifically provided as appropriate to the classification of the crane, hoist, lift or scaffolding or part of it that is under consideration.
- (2) However, the following forces or moments need not be so increased:
  - (a) those due to braking forces arising from decelerating travelling or traversing live loads;
  - (b) those due to inertia and momentum of live loads if those due to wind together with those referred to in the paragraph (a) are so great that they govern the proportion of the member concerned;
  - (c) those due to wind.



**Table 125 Compensation ratio for live loads**

classification of crane or hoist or lift or scaffolding or relevant part of it	ratio in which internal force or moment must be increased	classification of crane or hoist or lift or scaffolding or relevant part of it	ratio in which internal force or moment must be increased
1	1.2	3	1.6
2	1.4	4	1.9

- (3) Table 125 applies if more specific provision is not made in this section.
- (4) To make allowance for shocks caused by travelling or traversing movements of cranes or hoists or lifts or scaffolding, internal forces or moments caused by dead loads shall be increased by 10% if the track rails are interrupted by joints or gaps, and the speed of travel or traverse is 200 or less feet per minute, or 20% if the speed is exceeded.
- (5) If the track rails are not so interrupted, the internal forces or moments shall be increased by 10% if the speed is 300 or less feet per minute or 20% if the speed is exceeded.

## Maximum permissible stresses

### 126

- (1) The stresses imposed or developed in any member, component, part, or attachment, of any crane, hoist, lift, scaffolding, plant or gear shall be computed and after inclusion of all relevant increases consequential to section 125 and the other sections as may be applicable shall not exceed the relevant and appropriate maximum prescribed by this regulation.

**Part 11** Basic requirements about design and construction, erection, use, maintenance, inspection and testing with particular reference to cranes, lifts, hoists, scaffolding and plant

Section 126

- (2) If the member, component, part or attachment is of timber, the stress imposed or developed in it shall not exceed the relevant and appropriate maximum shown in table 126.1, or any other stress that may be more specifically prescribed elsewhere in this regulation.

**Table 126.1 Maximum permissible stresses for timbers**

nature of stress	maximum permissible stress in lb/in <sup>2</sup>					
	Douglas fir		ironbark less than 6 inches thick	ironbark 6 inches or more in thickness	†hardwood less than 6 inches in thickness	†hardwood 6 inches or more in thickness
	select	ordinary				
transverse; timber continually dry	2 000	1 450	6 000	4 500	4 000	3 000
transverse; timber occasionally wet but quickly drying	1 720	1 250	5 700	4 270	3 800	2 800
transverse; timber more or less continually wet or damp	1 330	970	5 700	4 270	3 800	2 800
compression; perpendicular to grain; continually dry	430	390	1 000	1 000	880	880
compression; perpendicular to grain; occasionally wet but quickly drying	300	270	1 000	1 000	750	750
compression; perpendicular to grain; timber more or less continually wet or damp	270	240	1 000	1 000	750	750
*longitudinal shear; in flexural members	112	86	340	340	300	300

nature of stress	maximum permissible stress in lb/in <sup>2</sup>					
	Douglas fir		ironbark less than 6 inches thick	ironbark 6 inches or more in thickness	†hardwood less than 6 inches in thickness	†hardwood 6 inches or more in thickness
	select	ordinary				
shearing; parallel to grain	230	170	1 000	1 000	750	750
tensile; parallel to grain	may be taken to be of the same values as transverse stresses					
compression; parallel to grain; continually dry	1 440	1 200	4 000	3 000	3 600	2 700
compression; parallel to grain; occasionally wet but quickly drying	1 320	1 080	3 800	2 800	3 400	2 500

\* Generally termed 'horizontal shear'.

† *Hardwood* includes only Australian hardwoods of approximately the same strength and reliability as spotted gum.

- (3) Table 126.1 applies if more specific provision is not made in this regulation.
- (4) If the member, component, part or attachment is of any other material, the stress imposed or developed in it shall not exceed that prescribed by section 122 (4) to (23), and amplified in relation to certain commonly used materials by table 126.2:

**Part 11**

Basic requirements about design and construction, erection, use, maintenance, inspection and testing with particular reference to cranes, lifts, hoists, scaffolding and plant

## Section 126

**Table 126.2 Physical properties of materials**

material	1/10 of 1% proof stress (t/in <sup>2</sup> )		1/2 endurance range for average stress zero (t/in <sup>2</sup> )		modulus of elasticity (t/in <sup>2</sup> )	modulus of rigidity (t/in <sup>2</sup> )	minimum nominal ultimate tensile strength (t/in <sup>2</sup> )
	tensile	shear	transverse*	torsional†			
mild steel	17	10.2	12.5	6.3	13 000	5 200	28
high tensile structural steel conforming to British Standard Specification No 548—1934	20	12	15	7.5	13 000	5 200	37
high tensile structural steel conforming to British Standard Specification No 968—1941	18	10.8	13.25	6.6	13 000	5 200	33
cast steel (annealed)	17.5	10.5	15	7.5	13 000	5 200	35
malleable cast iron ('black heart')	9	4.5	11	5.5	11 200	4 480	22.3
good grey cast iron	3	2.9	5.3	4.25	6 700	2 680	10
phosphur bronze (89 copper 11 tin)	8.7	5.2	10.7	8.5	5 540	2 220	15.5

material	1/10 of 1% proof stress (t/in <sup>2</sup> )		1/2 endurance range for average stress zero (t/in <sup>2</sup> )		modulus of elasticity (t/in <sup>2</sup> )	modulus of rigidity (t/in <sup>2</sup> )	minimum nominal ultimate tensile strength (t/in <sup>2</sup> )
	tensile	shear	transverse*	torsional†			
gunmetal ('admiralty bronze')	7.5	4.5	5	4	5 700	2 280	13.4
cast aluminium bronze (90 copper, 10 aluminium)	11.1	6.7	11.6	9.3	6 700	2 680	35
phenolic laminated material‡	..	..	2.68	..	400	..	2.9

\* As determined by rotating bar test on 10 million cycle basis.

† As determined by reciprocating bar test on 10 million cycle basis.

‡ If approved by chief inspector.

**Part 11** Basic requirements about design and construction, erection, use, maintenance, inspection and testing with particular reference to cranes, lifts, hoists, scaffolding and plant

Section 126

---

- (5) If the stresses include those due to wind loads, they may exceed the maximum mentioned by 25% provided—
  - (a) that the increase is solely due to wind loading; and
  - (b) that the strength of the structure so determined will not be less than it would have been if wind loading had been disregarded.
- (6) If a mild steel member of H, T or I section is used as a beam or cantilever, the stress imposed or developed in the tension flange shall not exceed 12 tons per square inch.
- (7) The stress imposed or developed in the compression flange of a cantilever shall not exceed that prescribed for a beam of twice the length of the cantilever; each half length of the beam shall be assumed loaded with identical loading and incidence of loading to that on the cantilever.
- (8) The beam thus loaded will have a central reaction equal in magnitude to twice the algebraic sum of the loads on the cantilever, and the position of the point of application of this reaction shall determine whether the beam load is applied to the compression flange, or tension flange, or centroid of the beam section.
- (9) If the principal external loading is concentrated and is applied to the compression flange of a beam of the section, the stress imposed or developed in the flange shall not exceed the lesser of the following stresses:
  - (a)  $14^{4/10}$  tons per square inch, or
  - (b) that determined by the formula  $\frac{8210}{ld / bt}$  tons per square inch.

- (10) In subsection (9):

***b*** means the least breadth of the compression flange that can be measured within a distance of  $\frac{1}{4}$  of the span of the beam of the section at which the stress is determined.

***d*** means the overall depth of the section of the beam at which the stress is determined, exclusive of any track rail laid on it.

***l*** means the maximum length of compression flange that is not supported laterally by adequate external means.

***t*** means the thickness of the compression flange measured as provided for flange thickness of Australian Standard Beam Sections by Australian Standard Specification No AI—1940, for structural steel.

- (11) If the compression and tension flanges of a beam are of different sections, or if the beam is of the single plate web girder type, the flange thickness ***t*** must be determined from the formula—

$$t = \frac{5I_y}{b^3}.$$

- (12) In subsection (11):

***b***—see subsection (10).

***I<sub>y</sub>*** means the moment of inertia of the cross-section of the beam about its minor rectilinear axis, provided that if the compression and tension flanges are of different section.

- (13) ***I<sub>y</sub>*** must be taken as equal to twice the moment of inertia of the compression flange about the aforesaid axis, and provided that if the compression flange of an Australian Standard Beam Section is not compounded, ***t*** may be determined as prescribed in this section for the standard beam section.

- (14) Track rails need not be included when determining flange thicknesses, ***t***.

**Part 11** Basic requirements about design and construction, erection, use, maintenance, inspection and testing with particular reference to cranes, lifts, hoists, scaffolding and plant

Section 126

---

- (15) If the principal external loading is concentrated and is applied at the centroid axis of the beam, the formula  $\frac{9980}{ld/bt}$  tons per square inch may be substituted for the formula stated in subsection (9) (b).
- (16) If the principal external loading is concentrated and is applied to the tension flange of the beam, the formula  $\frac{12120}{ld/bt}$  tons per square inch may be substituted for the formula stated in subsection (9) (b).
- (17) These maximum stresses are permissible only for beams or cantilevers of mild steel conforming to Australian Standard Specification No A.I—1940, ‘Rolled Steel Sections for Structural Purposes’.
- (18) For a beam or cantilever of the same type but of steel conforming to British Standard Specification No 548—1934, ‘High Tensile Structural Steel for Bridges, etc, and General Building Construction’, or British Standard Specification No 968—1941, ‘High Tensile (Fusion Welding Quality) Steel for Bridges, etc, and General Building Construction’, the stress imposed or developed in the tension flange shall not exceed 15 tons per square inch, and in the compression flange of the beam, the lesser of the following stresses:
- (a)  $17\frac{6}{10}$  tons per square inch; or
  - (b) that determined by the formula stated in subsection (9) (b) or the alternative provided in subsection (15) or (16).
- (19) If a member of H, T or I section is used as a beam and the principal external loading is applied to the compression flange, and if the loading is evenly distributed throughout the span of the beam and is greater in magnitude than any concentrated loading that may be simultaneously applied, the stress imposed or developed in the flange shall not exceed the lesser of the following stresses—
- (a)  $14\frac{4}{10}$  tons per square inch, or



- (b) that determined by the formula  $\frac{7140}{ld/bt}$  tons per square inch.
- (20) In subsection (19):
- b*—see subsection (10).
- d*—see subsection (10).
- l*—see subsection (10).
- t*—see subsection (10).
- (21) If the external loading is applied at the centroid axis of the beam, the formula  $\frac{8570}{ld/bt}$  tons per square inch may be substituted for that stated in subsection (19) (b), and if the loading is applied to the tension flange of the beam, the formula  $\frac{9640}{ld/bt}$  tons per square inch may be so substituted.
- (22) These maximum stresses are permissible only for beams or cantilevers of mild steel conforming to Australian Standard Specification No A.I.—1940, ‘Rolled Steel Sections for Structural Purposes’.
- (23) For a beam or cantilever of the same type, but of steel conforming to British Standard Specification No 548—1934, ‘High Tensile Structural Steel for Bridges, etc, and General Building Construction’, or British Standard Specification No 968—1941, ‘High Tensile (Fusion Welding Quality) Steel for Bridges, etc, and General Building Construction’, the stress imposed or developed in the tension flange shall not exceed 15 tons per square inch, and in the compression flange of the beam, the lesser of the following stresses:
- (a)  $17^{6/10}$  tons per square inch; or

**Part 11** Basic requirements about design and construction, erection, use, maintenance, inspection and testing with particular reference to cranes, lifts, hoists, scaffolding and plant

Section 126

---

- (b) that determined by the formula stated in subsection (19) (b) or the alternative provided in subsection (21).
- (24) The computed deflection of a steel beam in the direction of either the major or minor rectilinear axis of any cross-section shall not exceed  $\frac{1}{380}$  part of the span of the beam.
- (25) The computed deflection at the extremity of a steel cantilever shall not, when measured in the direction of either the major or minor rectilinear axis of any cross-section, exceed  $\frac{1}{190}$  part of the length of the cantilever.
- (26) For the purpose of computing the deflections, the modulus of elasticity of steel shall be deemed to be 13 000 tons per square inch.
- (27) In computing deflections it shall be necessary to increase the forces producing the deflections in the way provided by section 125.
- (28) Forces shall be considered to act simultaneously, and the horizontal forces referred to in section 124 shall be included.
- (29) The maximum vertical shearing stress in the webs of rolled steel joists, channels or plate-web girders of mild steel conforming to Australian Standard Specification No A.I—1940 ‘Rolled Steel Sections for Structural Purposes’ shall not exceed 6 tons per square inch.
- (30) If the members are of steel conforming to British Standard Specification No 548—1934, ‘High Tensile Structural Steel for Bridges, etc, and General Building Construction’, or British Standard Specification No 968—1941, ‘High Tensile (Fusion Welding Quality) Steel for Bridges, etc, and General Building Construction’, the maximum vertical shearing stresses in the webs shall not exceed  $7\frac{1}{4}$  tons per square inch.

- (31) The shearing stresses mentioned in subsections (29) and (30) are permissible only if the ratio—

$$\frac{\text{depth of web}}{\text{thickness of web}}$$

does not exceed 83 for the mild steel or 75 for the high tensile steel members.

- (32) For the purposes of web-shearing computations the depth of web of a rolled steel joist or channel may be taken as the full depth of the joist or channel, and the depth of web of a plate girder may be taken as the depth of the girder, measured between the centroid axes of the respective compression and tension flanges.
- (33) If the ratios of depth to web thickness mentioned in subsection (31) are exceeded, the maximum vertical shearing stress shall not exceed that determined by the formula—

$$5100K \left( \frac{\text{thickness of web}}{\text{depth of web}} \right)^2 \text{ tons per square inch.}$$

- (34) For subsection (33), the value of **K** shall be selected from table 126.3 in conformity with, and as appropriate to the ratio  $\frac{d_1}{d}$  where  $d_1$  is the longer and  $d$  the lesser rectilinear dimensions of the panels into which the web is divided by effective stiffeners, measured in the vicinity of the stress assessed.

**Table 126.3**

ratio $\frac{d_1}{d}$	1.0	1.2	1.4	1.5	1.6	1.8	2.0	2.5	3.0	$\infty$
<b>K</b>	9.42	8.0	7.3	7.1	7.0	6.8	6.6	6.3	6.1	5.35

**Part 11** Basic requirements about design and construction, erection, use, maintenance, inspection and testing with particular reference to cranes, lifts, hoists, scaffolding and plant

Section 126

(35) If vertical shearing stresses are low and the depth of web is less than 132 times the web thickness for mild, or 120 times the web thickness for high tensile steels as mentioned in subsections (29) and (30), the following compressive stresses shall not be exceeded at any section of the web:

- (a) for such mild steel—8 tons per square inch;
- (b) for such high tensile steel—9 tons per square inch.

(36) If relationships of web depths to thicknesses mentioned in subsection (35) are exceeded, the compressive stress in the web shall not exceed that determined by the formula—

$$6200K \left( \frac{\text{thickness of web}}{\text{depth of web}} \right)^2 \text{ tons per square inch.}$$

(37) For subsection (36), the value of **K** shall be selected from table 126.4 in conformity with, and appropriate to the ratio  $\frac{d_1}{d}$  with the same meaning as mentioned in subsection (34).

**Table 126.4**

ratio $\frac{d_1}{d}$	0.4	0.5	0.6	0.67	0.75	0.8	0.9	1.0	1.5	2.0	3.0	8
<b>K</b>	23.9	21.1	19.8	19.7	19.8	20.1	21.1	21.1	19.8	19.7	19.8	19.7

(38) The stress at the bottom of the Whitworth thread of a bolt or tie rod or other threaded member of mild steel shall not exceed—

- (a) 8 000 pounds per square inch for threads up to and including  $\frac{1}{2}$  an inch in diameter;
- (b) 12 000 pounds per square inch for threads  $\frac{5}{8}$  of an inch in diameter;

- (c) 16 000 pounds per square inch for threads  $\frac{3}{4}$  of an inch in diameter;
  - (d) 20 000 pounds per square inch for threads  $\frac{7}{8}$  of an inch in diameter;
  - (e) 24 000 pounds per square inch for threads 1 inch in diameter;
  - (f) 25 000 pounds per square inch for threads  $1\frac{1}{8}$  inches in diameter;
  - (g) 26 000 pounds per square inch for threads  $1\frac{1}{4}$  inches in diameter;
  - (h) 27 000 pounds per square inch for threads  $1\frac{3}{8}$  inches in diameter;
  - (i) 28 000 pounds per square inch for threads  $1\frac{1}{2}$  inches and over in diameter.
- (39) The stress in a compression member, or strut, of mild steel shall not exceed that shown in table 126.5, relevant and appropriate to the ratio of slenderness of the member.
- (40) If the member is of high tensile structural steel, the stress shall not exceed that shown in table 126.6 relevant and appropriate to the ratio of slenderness of the member.
- (41) The ratio shall be determined by dividing the greatest length of member that is not supported effectively against lateral deflection, by the least radius of gyration of any cross-section of the member within the central  $\frac{1}{2}$  of the length of the member.
- (42) If 1 end of the member is fixed and the other end free, the ratio of slenderness shall be determined by dividing twice the length of the member by the least radius of gyration of any cross-section within  $\frac{1}{2}$  of the length of the member of the fixed end.

**Part 11** Basic requirements about design and construction, erection, use, maintenance, inspection and testing with particular reference to cranes, lifts, hoists, scaffolding and plant

Section 126

**Table 126.5 Maximum stresses permissible in mild steel\* compression members or struts subject only to concentric axial loading**

ratio of slenderness	maximum permissible stress in t/in <sup>2</sup>					
	members having both ends hinged		members having 1 end fixed and 1 end hinged		members having both ends fixed	
	A	B	A	B	A	B
10	14.2	10.8	14.2	12.5	12.5	14.3
20	13.8	10.7	14.0	12.4	12.4	14.2
30	13.2	10.6	13.6	12.3	12.3	14.0
40	12.4	10.4	13.0	12.0	12.0	13.6
50	11.4	10.0	12.3	11.6	11.6	13.2
60	10.1	9.5	11.4	11.1	11.1	12.7
70	9.0	8.8	10.6	10.5	10.5	12.2
80	7.8	7.8	9.7	9.7	9.7	11.6
90	6.8	6.8	8.9	8.9	8.9	11.0
100	5.8	5.8	8.0	8.0	8.0	10.3
110	5.1	5.1	7.3	7.3	7.3	9.5
120	4.5	4.5	6.6	6.6	6.6	8.7
130	4.0	4.0	6.0	6.0	6.0	7.9
140	3.5	3.5	5.4	5.3	5.3	7.2
150	3.1	3.1	4.9	4.7	4.7	6.4
160	2.8	2.8	4.5	4.2	4.2	5.6
170	2.5	2.5	4.1	3.7	3.7	4.9
180	2.3	2.3	3.8	3.3	3.3	4.3
190	2.2	2.2	3.5	3.0	3.0	3.8

ratio of slenderness	maximum permissible stress in t/in <sup>2</sup>					
	members having both ends hinged		members having 1 end fixed and 1 end hinged		members having both ends fixed	
	A	B	A	B	A	B
200	2.1	2.1	3.3	2.7	2.7	3.4
210	2.0	2.0	3.1	2.5	2.5	3.1
220	1.9	1.9	2.9	2.4	2.4	2.9

\* Mild steel conforming to Australian Standard Specification No A1—1940, 'Rolled Steel Sections for Structural Purposes'. Column 'B' is applicable to members of angle, tee or tube section, and to members of latticed, battened or other framed construction.

Permissible stresses for intermediate ratios of slenderness should be interpolated.

**Table 126.6 Maximum stresses permissible in high tensile\* steel compression members or struts subject only to concentric axial loading**

ratio of slenderness	maximum permissible stress in t/in <sup>2</sup>					
	members having both ends hinged		members having 1 end fixed and 1 end hinged		members having both ends fixed	
	A	B	A	B	A	B
10	17.9	13.7	18.0	16.0	18.2	18.2
20	17.6	13.6	17.8	15.9	18.1	18.1
30	16.9	13.5	17.4	15.7	17.9	17.9
40	16.0	13.1	16.7	15.4	17.5	17.5
50	14.7	12.5	15.8	14.7	17.0	17.0
60	12.8	11.5	14.4	13.8	16.0	16.0
70	10.6	10.3	12.5	12.3	14.4	14.4
80	8.5	8.5	10.5	10.5	12.6	12.6
90	7.0	7.0	9.1	9.1	11.3	11.3

**Part 11** Basic requirements about design and construction, erection, use, maintenance, inspection and testing with particular reference to cranes, lifts, hoists, scaffolding and plant

Section 126

ratio of slenderness	maximum permissible stress in t/in <sup>2</sup>					
	members having both ends hinged		members having 1 end fixed and 1 end hinged		members having both ends fixed	
	A	B	A	B	A	B
100	5.9	5.9	8.0	8.0	10.3	10.3
110	5.1	5.1	7.3	7.3	9.5	9.5
120	4.5	4.5	6.6	6.6	8.7	8.7
130	4.0	4.0	6.0	6.0	8.0	7.9
140	3.5	3.5	5.4	5.3	7.4	7.2
150	3.1	3.1	4.9	4.7	6.8	6.4
160	2.8	2.8	4.5	4.2	6.2	5.6
170	2.5	2.5	4.1	3.7	5.7	4.9
180	2.3	2.3	3.8	3.3	5.2	4.3
190	2.2	2.2	3.5	3.0	4.8	3.8
200	2.1	2.1	3.3	2.7	4.4	3.4
210	2.0	2.0	3.1	2.5	4.2	3.1
220	1.9	1.9	2.9	2.4	3.9	2.9

\* High tensile steel conforming to British Standard Specification No 548—1934, 'High Tensile Steel for Bridges, etc., and General Building Construction', of British Standard Specification No 968—1941, 'High Tensile (Fusion Welding Quality) Steel for Bridges, etc., for General Building Construction'. Column 'B' is applicable to members of angle, tee, or tube sections and to members of latticed, battened or other framed construction.

Permissible stresses for intermediate ratios of slenderness should be interpolated.

- (43) If the radius of gyration of the cross-section of a compression member or strut of metal or alloy is less near the ends of the member than in the vicinity of the half-length of the member, the radius of gyration



of a cross-section at the half-length shall for the purpose of assessing the slenderness ratios, be reduced in the ratio—

$$\frac{Kq}{0.75.K}$$

- (44) In subsection (43):

**K** is the least radius of gyration of a section at the half-length of the member.

**Kq** is the least radius of gyration of the least section that is  $\frac{1}{4}$  of the length of the member from either end.

- (45) If a steel member is subject to simultaneous axial compression and transverse stress it shall be designed as a beam, or if free at 1 end, a cantilever, in which the maximum transverse stress is determined by the formula—

$$\left( \frac{cf}{1.67f_p} + f_x + f_y \right) \text{ tons per square inch}$$

where, in relation to the section under consideration:

**c** is a constant, having the value 18 for mild steel, or 22 for high tensile structural steel.

**f** is the maximum axial compressive stress.

**f<sub>p</sub>** is the maximum permissible axial compressive stress as prescribed in this section for the same member if assumed subject solely to axial stress.

**f<sub>x</sub>** and **f<sub>y</sub>** are the maximum transverse stresses due to external flexural forces acting or resolved about the respective principal rectilinear axes.

- (46) The stress in a compression member or strut of timber shall not exceed that shown in table 126.7, relevant and appropriate to the ratio

**Part 11** Basic requirements about design and construction, erection, use, maintenance, inspection and testing with particular reference to cranes, lifts, hoists, scaffolding and plant

Section 126

of slenderness of the member, and to the kind of timber and its sectional dimensions.

- (47) The ratio of slenderness shall be determined by dividing the greatest length of member that is not supported effectively against lateral deflection, by the diameter of the greatest inscribed circle of any cross-section of the member within the central half of the length of the member.
- (48) If 1 end of the member is fixed and the other end free, the ratio of slenderness shall be determined by dividing twice the length of the member by the diameter of the greatest inscribed circle of any cross-section of the member within half the length of the member of the fixed end.

**Table 126.7 Maximum stresses permissible in timber compression members or struts subject only to concentric axial loading**

ratio of slenderness	maximum permissible stress in lb/in <sup>2</sup>			
	ironbark less than 6 in <sup>2</sup> in section	ironbark 6 in <sup>2</sup> or more in section and hardwood* less than 6 in <sup>2</sup> in section	hardwood* 6 in <sup>2</sup> or more in section	Douglas fir (Oregon pine)
0	5 000	4 000	3 000	1 400
5	4 390	3 560	2 714	1 320
10	3 780	3 123	2 428	1 200
15	3 170	2 685	2 144	1 080
20	2 560	2 247	1 859	960
25	1 950	1 808	1 574	850
30	1 370	1 370	1 290	730
35	1 005	1 005	1 005	610
40	770	770	770	490

ratio of slenderness	maximum permissible stress in lb/in <sup>2</sup>			
	ironbark less than 6 in <sup>2</sup> in section	ironbark 6 in <sup>2</sup> or more in section and hardwood* less than 6 in <sup>2</sup> in section	hardwood* 6 in <sup>2</sup> or more in section	Douglas fir (Oregon pine)
45	608	608	608	384
50	493	493	493	312
55	407	407	407	262
60	342	342	342	222
65	292	292	292	192
70	252	252	252	168
75	219	219	219	140
80	192	192	192	120
85	170	170	170	113
90	152	152	152	102

Permissible stresses for intermediate ratios of slenderness should be interpolated.

Refer to s 131 about quality of timber.

- \* Hardwood includes only Australian Hardwoods of approximately the same strength and reliability as Spotted Gum.

- (49) If a timber member is subject to simultaneous axial compression and transverse stress it shall be designed as a beam, or if free at 1 end, a cantilever, in which the maximum transverse stress is determined by the formula—

$$\left( \frac{cf}{2.f_p} + fx + fy \right) \text{ pounds per square inch}$$

where, in relation to the section under consideration:

$c$  is a constant, having the value 8000 for ironbark or other Australian hardwood timbers, or 3600 for Douglas fir (Oregon pine).

$f$  is the maximum axial compressive stress.

$fp$  is the maximum permissible axial compressive stress as prescribed in this section for the same member if assumed subject solely to axial stress.

$fx$  and  $fy$  are the maximum transverse stresses due to external flexural forces acting or resolved about the respective principal rectilinear axes.

- (50) If the cross-section of a timber compression member or strut is less near the ends of the member than in the vicinity of the half-length of it, the diameter of the inscribed circle referred to in subsections (47) and (48) shall, for the purpose of assessing the slenderness ratio, be reduced in the ratio—

$$\frac{Dq}{0.75D}$$

where:

$D$  is the diameter of the greatest inscribed circle of a section at the half-length of the member.

$Dq$  is the diameter of the greatest inscribed circle of the least section that is  $\frac{1}{4}$  of the length of the member from either end.

- (51) The computed early deflection of a timber beam in the direction of either the major or minor rectilinear axis of any cross-section shall not exceed  $\frac{1}{380}$  part of the span of the beam.
- (52) The computed early deflection at the extremity of a timber cantilever shall not when measured in the direction of either the major or minor rectilinear axis of any cross-section, exceed  $\frac{1}{190}$  part of the length of the cantilever.

- (53) The computed early deflection of a timber beam used for scaffolding or shoring purposes, shall not exceed  $\frac{1}{150}$  part of the span of the beam, provided that the computed early deflection of platform planks of bricklayers' or similar heavy scaffoldings shall not exceed  $\frac{1}{60}$  part of their span, and that the computed early deflection of platform planks of decorators' or similar scaffoldings of the lightest type shall not exceed  $5\frac{1}{2}$  inches.
- (54) For the purpose of computing the deflections the modulus of elasticity of the constituent timber shall be deemed to be—
- (a) for ironbark—1 300 tons per square inch; and
  - (b) for other hardwoods—1 050 tons per square inch; and
  - (c) for Douglas fir (Oregon pine)—715 tons per square inch.
- (55) In computing deflections it shall be necessary to increase the forces producing the deflections in the way provided by section 125.
- (56) Forces shall be considered to act simultaneously and the horizontal forces referred to in section 124 shall be included.
- (57) The thickness of a timber beam or cantilever shall not be less than  $\frac{1}{4}$  of the depth of the beam or cantilever.
- (58) If 1 bridge beam only of an overhead traveller crane is supported laterally by effective bracings, the other bridge beam may be considered to derive from it a measure of lateral support per medium of the crab frame and its track wheels, provided the wheels have double flanges and together with their supports and fastenings are considered by the chief inspector to be suitable for the purpose.
- (59) In such case the strength of the unbraced beam may be determined by placing the fully-loaded crab at whatever position is productive of the greatest critical stress.

**Part 11** Basic requirements about design and construction, erection, use, maintenance, inspection and testing with particular reference to cranes, lifts, hoists, scaffolding and plant

Section 126

---

- (60) The maximum stress then resulting at any section of the unbraced beam shall not exceed the maximum stress permissible for the same beam when the laterally unsupported length is deemed to be  $\frac{3}{4}$  of the actual span.
- (61) The lateral deflection due to all loads other than those applied by the crab wheels shall not exceed  $\frac{1}{2}$  an inch, when calculated on the assumption that the crane is brought evenly to rest from its maximum travelling speed in a distance of 5 feet.
- (62) Other deflections with the crab at any position shall not, however, exceed those elsewhere prescribed for beams by this regulation.
- (63) The ratio of slenderness of a tension member shall not exceed 300.
- (64) The ratio shall be determined as though the member were a compression member.
- (65) After being increased as prescribed by subsection (67), the torsional stress imposed or developed in any spring made from carbon spring steel shall not exceed the relevant and appropriate maximum stress shown in table 126.8.
- (66) It shall not be necessary to increase the computed forces on, or moments in, a spring in the way otherwise prescribed by section 125, unless alternation occurs, and in such case the provisions of section 122 shall apply.

**Table 126.8 Maximum torsional stresses permissible in springs of carbon spring steel (in pounds per square inch)**

diameter in inches of greatest circle that may be inscribed within the least section that is relevant of the material of which spring is made	classification of part of crane, hoist, plant, or scaffolding in which spring is employed		
	4	3	2 or 1
not exceeding 0.085	60 000	75 000	93 000
above .085 and no exceeding 0.185	55 000	69 000	85 000
above 0.185 and not exceeding 0.32	48 000	60 000	74 000
above 0.32 and not exceeding 0.53	42 000	52 000	65 000
above 0.53 and not exceeding 0.97	36 000	45 000	56 000
above 0.97 and not exceeding 1.5	32 000	40 000	50 000

(67) To compensate for errors consequential to computation of only torsional stresses in helical or volute springs, the computed torsional stress in any helical or volute spring shall be increased in the ratio **W**, the Wahl factor, shown in table 126.9 as relevant and appropriate to the relationship:

$$R = \frac{D}{d} .$$

(68) In subsection (67):

**D** is the maximum pitch circle diameter of the spring, measured in inches.

**d** is the diameter in inches of the greatest circle that may be inscribed within the least section that is relevant of the material of which the spring is made.

**Part 11** Basic requirements about design and construction, erection, use, maintenance, inspection and testing with particular reference to cranes, lifts, hoists, scaffolding and plant

Section 126

**Table 126.9 Compensating ratios, W, or Wahl factors, for stresses in helical or volute springs**

R =	W Wahl factor	R =	W Wahl factor	R =	W Wahl factor
2.0	2.06	4.2	1.38	7.6	1.19
2.1	1.98	4.3	1.37	7.8	1.19
2.2	1.90	4.4	1.36	8.0	1.18
2.3	1.84	4.5	1.35	8.5	1.17
2.4	1.79	4.6	1.34	9.0	1.16
2.5	1.75	4.7	1.34	9.5	1.15
2.6	1.71	4.8	1.32	10.0	1.14
2.7	1.68	4.9	1.32	10.5	1.14
2.8	1.64	5.0	1.31	11.0	1.13
2.9	1.60	5.2	1.30	11.5	1.12
3.0	1.58	5.4	1.28	12.0	1.12
3.1	1.56	5.6	1.27	12.5	1.11
3.2	1.53	5.8	1.26	13.0	1.11
3.3	1.51	6.0	1.25	13.5	1.11
3.4	1.49	6.2	1.24	14.0	1.10
3.5	1.48	6.4	1.24	14.5	1.10
3.6	1.46	6.6	1.23	15.0	1.10
3.7	1.44	6.8	1.22	16.0	1.09
3.8	1.43	7.0	1.21	17.0	1.08
3.9	1.42	7.2	1.21	18.0	1.08



---

$R = \frac{W}{\text{Wahl factor}}$	$R = \frac{W}{\text{Wahl factor}}$	$R = \frac{W}{\text{Wahl factor}}$
4.0	1.40	7.4
4.1	1.39	1.20
		19.0
		1.07

*Note* See also s (69) and s (70) about limiting values of R.

- (69) Springs in which the ratio **R** referred to in subsection (67) is less than 6 shall not be used unless specifically approved by the chief inspector.
- (70) If practicable, **R** shall be made equal to nine.
- (71) The value of **G**, the modulus of torsional rigidity shall, for carbon spring steel, be deemed to be 5 100 tons per square inch.

## General

### 127

- (1) If necessary or advisable for safe and continued operation, the members, components, parts, linkages and attachments of machinery mechanisms and gearings shall be machined.
- (2) Machining shall be such as to ensure accurate fitting, smooth and accurate working and freedom from shocks due to lost motion or to slackness or inaccuracy.
- (3) It shall also ensure truth, precision, correctness and regularity of form and of pitch and alignment.
- (4) 'Lost motion' shall be eliminated except if it is an essential feature of design.

**Part 11** Basic requirements about design and construction, erection, use, maintenance, inspection and testing with particular reference to cranes, lifts, hoists, scaffolding and plant

Section 127

---

- (5) Bolts, studs, set bolts, set screws, grub screws, adjusting screws and plain or screwed pins, eyebolts, tie bars, screw clevises and the like shall be prevented by positive means from developing undue longitudinal slackness or becoming displaced when used—
  - (a) in connecting or securing members between which relative motion occurs; or
  - (b) in positions in which they are required to be longitudinally slack; or
  - (c) in positions in which they are liable to become loosened by vibration; or
  - (d) in positions in which they are subjected to rapid changes of load; or
  - (e) in positions in which they are subjected to alternations of load; or
  - (f) in positions in which they are subjected to actions tending to unscrew them.
- (6) Split pins shall not be less in diameter than  $\frac{1}{4}$  of the thickness of the metal they traverse.
- (7) If split pins or taper pins are used in floating pins, washers shall be provided between the split or taper pins and adjacent rubbing surfaces.
- (8) Except if slackness is an essential feature of design, keys shall be well fitted and tightly driven, and feathers shall be well and tightly fitted.
- (9) Splines shall fit closely.
- (10) Axles, sheave pins, or shafts, pins or spindles carrying revolving or oscillating parts shall, unless designed as lubricated revolving members, be effectively locked against rotation as well as against longitudinal displacement.

- (11) Internal threads and nuts shall be of effective axial length at least equal to  $\frac{7}{8}$  of the nominal diameter of their thread and shall engage with the male thread for their full length.
- (12) Balance, bias or operating weights of cranks, levers or linkages shall be secured in position by rivets, through bolts, welding or brazing.
- (13) All castings, pressings, stampings, flame cuttings, weldings and forgings shall be of true, correct, precise and regular form, pitch and alignment, well suited to their purpose and free from defects liable to impair their effectiveness or conducive of conditions of hazard, uncertainty or danger.
- (14) Lifting hooks that have opened out at the throat by 5% of their throat dimension shall not be used.
- (15) Lifting rings of which any internal diameter has increased or decreased by 5% shall not be used.
- (16) If members, components, parts, linkages or attachments are unduly loose or slack or unduly worn, deteriorated, or otherwise impaired or if they are so cracked, distorted, eroded, burned, fatigued, strain-hardened or in any way defective or so damaged as to be productive or conducive to conditions of hazard, uncertainty or danger, they shall be immediately replaced, or all use of them shall be immediately discontinued and all necessary or desirable action immediately taken to ensure that they are no longer productive or conducive to such conditions.
- (17) Members, components, parts, linkages or attachments, particularly operating cords, controls and brakes shall be so arranged and constructed that at all times they fulfil their functions freely and without obstruction.
- (18) They shall be constantly maintained and kept free of obstruction.
- (19) Effective interlocking devices of approved designs shall be provided—

**Part 11** Basic requirements about design and construction, erection, use, maintenance, inspection and testing with particular reference to cranes, lifts, hoists, scaffolding and plant

Section 127

---

- (a) if machinery or mechanisms are so arranged that they may be driven either manually or by power—to ensure that the means by which the agencies are adapted cannot be simultaneously engaged; or
  - (b) if alternative devices are provided for sustaining or controlling any load—to prevent their simultaneous disengagement and consequent loss of control of load; or
  - (c) in power cranes or power hoists, if any device other than a brake or friction clutch is provided for sustaining any load—to prevent driving against the load-sustaining device; or
  - (d) to prevent loads or lifting gear being lowered through hatchways on, or into the path of travel of, travelling cranes, and to prevent the cranes colliding with the loads; or
  - (e) to ensure that trolleys, carriages, or crabs cannot overrun or become otherwise displaced from their tracks, at or near moveable sections of them, or at or near crossovers, switches, turntables, or transfer positions; or
  - (f) to prevent the operation of any hoist or lift having a moving platform, cage, hopper, box, cradle, skip, kibble, bucket, vessel, tine, monkey or yoke while any enclosure door is not fully closed and locked; or
  - (g) to prevent the unlocking or opening of any enclosure door of any hoist or lift referred to in paragraph (f), except a door relative to which the platform, cage, hopper, box, cradle, skip, kibble, bucket, vessel, tine, monkey or yoke has attained such a position that persons may safely enter the enclosure; or
  - (h) as required by subsections (49) and (50) for speed-changing devices.
- (20) Unless the chief inspector so directs, subsection (19) (b) does not require the interlocking of a brake.

- (21) Subsection (19) (f) does not apply to temporary hoists used in building, demolition, excavation or compressed air work.
- (22) Linkages, including those employing ropes, shall, unless it is an essential feature of design, be so devised and constructed that they cannot attain 'deadcentre' or other self-locking or self-neutralising positions.
- (23) If owing to external agency the load supported by a crane or hoist may be subjected to major impact effects, shock absorbers of approved design shall be fixed in approved positions to relieve the crane or hoist of the effects.
- (24) All of the members, components, parts, linkages and attachments of cranes and hoists and lifts and scaffoldings and plant shall be effectively and strongly secured in position.
- (25) All load chains and all hand chains shall be caused to book correctly on their gipsies, sheaves, quadrants or the like by means of chain guides.
- (26) To avoid jamming of the chain, guide rollers shall not be used in proximity to gipsies.
- (27) Chain guides used with gipsies shall, if practicable, be of the fixed type.
- (28) Hand ropes shall be caused to book correctly on their sheaves, quadrants or the like by means of effective rope guides.
- (29) The total force required at the hand chain or hand rope of a crane, hoist, scaffolding or plant to raise, lower, handle or control the working load or for purposes of manipulation shall not exceed 80 pounds.
- (30) However, subsection (29) shall not apply to motions effectively controlled by trailing bandbrakes, weston type brakes, or automatic brakes analogous to them.

**Part 11** Basic requirements about design and construction, erection, use, maintenance, inspection and testing with particular reference to cranes, lifts, hoists, scaffolding and plant

Section 127

---

- (31) The end carriages or bogies of the following cranes shall be so designed, constructed and maintained that breakage of a track wheel or its axle will not allow the carriage or bogey to become vertically displaced by more than  $\frac{3}{4}$  of an inch:
- (a) cranes of the overhead traveller type;
  - (b) travelling derrick cranes;
  - (c) travelling gallows type cranes or gantries;
  - (d) overhead runways other than monorail runways;
  - (e) travelling portal and semi-portal cranes;
  - (f) travelling hammerhead cranes.
- (32) Worm or screw gearing shall not be employed in the machinery, mechanisms or gearings operating the following movements of scaffoldings, cranes, hoists or plant except when used in conjunction with the protective devices that are approved by the chief inspector:
- (a) the slewing movements of jib cranes;
  - (b) the power-driven travelling movements, whether longitudinal or transverse, of cranes.
- (33) However, subsection (32) does not apply to the mechanism by which ordinary vehicular or mobile cranes are propelled.
- (34) Scaffoldings, cranes, hoists, plant or gear, including their crabs and trolleys, shall be so designed, constructed and maintained that the loads are distributed between all supporting track or road wheels in a statically determinate way.
- (35) The slewing motions of power cranes having jibs or cantilevered booms shall be controlled by manually operated brakes.
- (36) The travelling motion of the following cranes shall be controlled from and at their main driving stations by manually operated brakes:

- (a) locomotive type power cranes;
  - (b) power cranes of the overhead traveller type;
  - (c) power cranes of the monorail or double-rail runway type of which the driver rides with or beside the load or lifting mechanism;
  - (d) vehicular power cranes;
  - (e) power cranes of the caterpillar type.
- (37) Cranes, hoists, lifts, scaffolding, plant or gear shall not be lubricated, tended or cleaned while in motion or while any member, component, part or attachment of them is in motion or while any member, component, part or attachment is in any way connected or liable to be connected with any energised associate, or any weight, load or force capable of causing it to move.
- (38) In addition to shutting off the power, effective and dependable mechanical means shall be taken to render the members, components, parts or attachments immovable and to thereby ensure the safety of persons inspecting, examining, testing, lubricating, tending, cleaning or adjusting the cranes, hoists, lifts, scaffolding, plant, or gear.
- (39) The application of brakes other than those of the screw-down type shall not be deemed to be a dependable mechanical means for subsection (38).
- (40) If it is not practicable to thus render the members, components, parts or attachments immobile and immovable in order that inspection, examination, test or adjustment may be safely carried out, a duly qualified driver shall remain at and in sole charge of the controls during the whole of the time of the inspection, examination, test or adjustment and shall move the members, components, parts or attachments only at and in accordance with each plain and specific direction of the person making the inspection, examination, test or

adjustment, but lubricating, tending, and cleaning shall not be carried out in this way.

- (41) This section shall not prevent cranes, engines or gear from being lubricated, tended or cleaned by means equally safe to that of rendering the members, components, parts and attachments immobile and immovable as mentioned in subsection (40).
- (42) Static counterbalance weights of cranes, hoists or scaffolding shall be effectively and strongly secured in position.
- (43) They shall be so devised and fixed that even if raised from their seatings in an emergency they will not become either partly or completely unshipped.
- (44) All suspended weights shall have such additional constraint, or fencing, that in the event of failure of their prime suspension they will not fall to the danger of persons in the vicinity.
- (45) Tapered washers or tapered packers shall be used under the heads and nuts or bolts, pins and tie rods that protect from surfaces not normal to their longitudinal axes to ensure an even distribution of loading on the heads and nuts.
- (46) Pawls shall not be used as load sustaining devices except—
  - (a) if so plainly visible to a person standing or sitting at the controls that the person can readily observe the depth to which each pawl has entered the teeth with which it engages; or
  - (b) if an approved indicator is provided to enable a person at the controls to ascertain the depth of engagement of the pawl as mentioned in paragraph (a).
- (47) However, pawls with approved accelerating springs or approved linkages may be used in Weston type brakes.
- (48) Pawls in enclosing casings or boxings shall be of the non-synchronous multiple type.



- (49) If any power-driven mechanism has a speed-changing or adjusting device by means of which load sustaining parts may be disconnected from the motive agency, a brake or other approved means shall be provided to control the disconnected parts.
- (50) The brake or alternative means shall, if the chief inspector so requires, be interlocked with the speed changing or adjusting device to prevent their simultaneous disengagement.
- (51) Brakes of mechanisms that can be reversed either under power or manually shall be fully effective in all directions.
- (52) Automatic brakes other than those of the shoe type or of the Weston (screw or helix) type shall not be used on the mechanisms.
- (53) All dynamically reversible mechanisms that can be energised by the action of gravity, momentum or wind shall have brakes or other approved devices by which all movements can be both controlled and prevented.
- (54) Electrically opened brakes shall be deemed not to fulfil the requirements of subsection (53).
- (55) A brake restraining a metal track wheel that runs on a metal track rail shall not for purposes of design be considered to develop a braking force between wheel and rail in excess of  $\frac{1}{10}$  of the pressure between the wheel and rail.
- (56) Non-automatic brakes shall have approved means by which they may be locked in the fully engaged position.
- (57) However, the locking devices may be omitted for brakes controlling the hoisting motions of overhead traveller cranes that lift or lower loads through heights not exceeding 30 feet.
- (58) In addition to any electrically-opened brakes, approved semiautomatic brakes shall be provided on power-driven mechanisms handling workers and materials to control the lowering motions.

**Part 11** Basic requirements about design and construction, erection, use, maintenance, inspection and testing with particular reference to cranes, lifts, hoists, scaffolding and plant

Section 127

---

- (59) The brakes shall function automatically on the manual release of a restraining device.
- (60) All brakes shall be lined with approved brake lining materials and the linings shall be so strongly and effectively fastened in place that they will not become loose or displaced even when so worn that replacement has become advisable.
- (61) Brake bands that are less in width than  $\frac{1}{5}$  of the diameter of their drums shall have restraining clips or double-flanged drums or other approved devices that ensure against their lateral displacement.
- (62) All ends of brake bands shall be concentric and hinged to ensure that the ends of the bands will not be subject to bending actions.
- (63) The use of rigid or partly-rigid intermediate joints in brake bands shall as far as practicable be avoided but if unavoidable the joints shall be of types that will not subject the bands to bending actions.
- (64) All manual and semiautomatic brakes shall be so devised, constructed and located that in an emergency they can be instantly applied.
- (65) If manual rotation of a screw thread or nut is necessary, brakes shall be so devised, constructed and located that alternative means of instantaneous application are available.
- (66) Effective means shall be provided for limiting the total movement of brake bands or shoes to the least practicable amount.
- (67) The total movement of a brake band in opening and closing shall be limited to an amount that will ensure against its excessive flexure or displacement or mounting.
- (68) Brakes shall open and close evenly to ensure correct action and regular wear of linings, their action shall be entirely smooth and free from chatter and they shall not stick or bind.

- (69) The total angular movement or ‘throw’ of the hand lever of any brake or clutch or the like shall not exceed 50°, and that of any pedal shall not exceed 30°.
- (70) Brakes shall be capable of exerting braking torques 50% greater than those transmitted to them, assuming conditions of static loading and an absence of friction except at the braking surfaces.
- (71) The braking torques shall be exerted by the brakes, if manually actuated, on application of a force not greater than 35 pounds to the hand lever, or, alternatively, 70 pounds to the foot pedal.
- (72) Every Weston (screw or helix) type brake shall be so designed that the holding torque developed by it at all times exceeds by at least 1% the load torque applied.
- (73) Unless specifically designed for operation with lubricated linings, brakes shall, if necessary or desirable, be effectively protected against entry of water or other lubricants.
- (74) Subject to subsection (95), the hoisting motions of cranes or hoists of the following types shall be controlled by automatic (trailing) bank brakes, or by approved Weston (screw or helix) type brakes:
- (a) mobile, caterpillar, and locomotive type cranes;
  - (b) hand-operated winches;
  - (c) hand-operated derrick cranes;
  - (d) hand-operated overhead traveller cranes.
- (75) The following motions of cranes or hoists of the following types shall be controlled by Weston (screw or helix) type brakes:
- (a) the hoisting motions of hand-operated stacking machines, gibbets, gallows, and chain blocks;
  - (b) the boom-elevating motion of mobile or portable conveyors;

**Part 11** Basic requirements about design and construction, erection, use, maintenance, inspection and testing with particular reference to cranes, lifts, hoists, scaffolding and plant

Section 127

---

- (c) the luffing and hoisting motions of power-driven travelling derrick cranes;
  - (d) the hoisting motions of cranes and hoists (other than power-driven hoisting blocks), that raise and lower loads through distances not greater than 10 feet.
- (76) Convenient and readily accessible means shall, unless the design renders them unnecessary, be provided by which brakes may be readjusted from time to time to compensate for wear and to ensure correct functioning.
- (77) Any brake that is closed by springs shall have at least 2 such springs.
- (78) They shall be so devised and arranged that in the event of failure of either, the brake will continue to function and to develop at least  $\frac{1}{2}$  of the holding torque prescribed by subsections (70) and (71).
- (79) Shoe brakes shall be so devised and constructed that the loads on opposing shoes automatically equalise and balance one another.
- (80) Brake shoe linkages shall be of the floating type so that appreciable eccentricity of diametral oscillation of brake drums will not cause variation in shoe loads.
- (81) The temperature of the rubbing surface of any brake shall not exceed—
- (a) 212° Fahrenheit for brakes lined with wood or fabric; or
  - (b) 400° Fahrenheit for brakes lined with bonded asbestos or approved non-combustible sintered materials.
- (82) Ropes wrapping round shafts or drums shall not be provided or used as brakes.
- (83) All foot pedals, and all foot rests or steps that accommodate only 1 foot of the user shall have heavily upturned edges or other approved devices to prevent slipping.

- (84) All levers, pedals and control linkages shall be so devised that persons using them cannot be injured by their recoil, backlash, or other movement under power.
- (85) If it is practicable to use trailing type (unidirectional) handbrakes or other approved brakes, pawls shall not be used in mechanisms holding, supporting or sustaining loads.
- (86) Mechanisms for hoisting or holding Proscenium Safety Fire Curtains shall not have pawls.
- (87) Centrifugal brakes or other approved automatic speed regulating devices shall be provided to control the speed of descent of Proscenium Safety Fire Curtains and of other loads that are required to descend unattended.
- (88) Toothed or dog clutches shall not have less than 4 teeth or 4 dogs.
- (89) The teeth or dogs and their mating recesses shall be undercut sufficiently to prevent inadvertent disengagement of clutches.
- (90) Cone and other friction clutches shall be so designed that they will not seize or become locked in engagement.
- (91) The chief inspector may require any cone clutch to be lined with an approved clutch lining material.
- (92) All manually operated clutches shall be actuated by means of levers, pedals, or other approved controls.
- (93) All clutches shall be so designed and constructed that they can not drift or become otherwise inadvertently engaged or disengaged.
- (94) Worm gearings having machined teeth and other worm gearings in which the angle of lead of the worm exceeds 3° shall be deemed incapable of stopping or holding loads, and mechanisms employing the gearings shall have brakes as prescribed by subsection (53).

**Part 11** Basic requirements about design and construction, erection, use, maintenance, inspection and testing with particular reference to cranes, lifts, hoists, scaffolding and plant

Section 127

---

- (95) If worm gearing or a solenoid brake is employed in connection with any jib or derrick crane for raising or lowering loads, and if the crane depends on gravitational forces for stability, an approved clutch shall be provided in such position that in an emergency the load may, if desired, be released, or alternatively lowered rapidly under the control of an approved brake that shall also be provided for the purpose.
- (96) All hoists and lifts used for raising or lowering workers shall have approved safety gear that shall be so devised and constructed that if the vehicle in which the workers ride becomes separated or detached from its hoisting agency, it will immediately and automatically on separation or detachment become securely locked to its guides, runners, or supporting structure and remain so locked even if it is reconnected to its hoisting agency and its weight again transferred to it.
- (97) However—
- (a) if the safety gear is entirely self-resetting, it may automatically release its grip on the guides, runners or supporting structure after the weight of the vehicle has again been transferred to the hoisting agency; or
  - (b) the safety gear shall not function while the vehicle is ascending; or
  - (c) if the distance travelled by the vehicle exceeds 30 feet—the chief inspector may require the safety gear to function if and as the vehicle attains a speed 40% greater than its rated speed; or
  - (d) if the rated speed is less than 100 feet per minute—the safety gear shall function if and as it reaches 140 feet per minute.
- (98) The platforms of all hoists for raising or lowering workers shall have sides extending not less in height than 6 feet above the platform flooring, and the sides shall constitute continuous surfaces free from apertures.

- (99) Any side or end not used for loading or unloading or for access shall also be fenced.
- (100) Any side or end that is used for loading, unloading or access shall be enclosed or fenced by approved gates or doors extending to the same height, or if approved, by rails set at a height of 3 feet above the platform flooring, and at a distance of 8 inches back from the platform edge served.
- (101) The hoist platform shall have a robust roof or head cover to prevent persons being struck by falling objects.
- (102) Hand rails or other grips shall be provided overhead, or on the continuous surfaces mentioned in subsection (98) for the use of persons travelling in the hoist.
- (103) If loads are raised or lowered in open topped, open sided or open ended vessels, kibbles, boxes or trays, or in bags, above workers in shafts, well holes, or other confined spaces, monkeys or other approved means shall be employed to prevent them colliding with the sides of the shaft or well hole, or anything in it.
- (104) However, the monkeys or means shall not be deemed necessary if the hoisting rope or chain may be freely displaced in any direction through an angle of 5° from the vertical without the suspended load, vessel, kibble, box, or tray coming into contact with the sides of the shaft or well hole or anything in it.
- (105) If loads guided by a monkey are raised or lowered above workers in confined or partly confined areas, the monkeys shall have approved safety gear so devised and constructed that if the weight of the monkey is removed from the hoisting agency at any position within the limits of its travel it will immediately and automatically on removal become securely locked to its guides.

- Part 11** Basic requirements about design and construction, erection, use, maintenance, inspection and testing with particular reference to cranes, lifts, hoists, scaffolding and plant

Section 127

---

- (106) The kibble, truck or vessel the monkey is employed to guide shall be so fastened to the monkey that it will only be automatically released after the monkey has attained its lowermost limit of travel.
- (107) If loads are raised, lowered, handled or transported on hooks, or other media, under circumstances in which it is necessary or desirable to prevent them becoming unshipped or displaced from it, approved safety hooks, or other approved means shall be adopted to prevent the unshipping or displacement, or to prevent injury (or both) to any person in the vicinity.
- (108) This subsection applies to the following lifting devices:
- (a) grabs, dogs, clamps and magnets;
  - (b) all lifting devices that either—
    - (i) function by the agency of friction, fluid pressure, vacuumatic action, magnetism, local indentation of surfaces, or minor irregularities of surfaces, or any combination of them; or
    - (ii) are of such a nature that they are liable to become detached from the load or otherwise displaced from it in the event of the slackening of their slings or the sudden movement of any supporting member.
- (109) No lifting device to which subsection (108) applies shall be used to raise, lower or transport loads—
- (a) in any circumstances in which any person might be injured should the load or part of it become detached or fall; or
  - (b) in any circumstances in which the device might dislodge or overturn any material, object or stock to the danger of any person; or
  - (c) in any way prejudicial to the safety of any person.



- (110) If in conformity with section 128 rail clamps are provided for locking any crane or hoist to its track rails, the clamps shall be so devised and constructed that they function immediately and automatically on the operation of an instantaneous type tripping device set closely adjacent to the main controls of the crane or hoist.
- (111) The energy required to close and lock the clamps shall be derived from a descending weight or from springs set in pairs and so arranged that in the event of failure of either, the clamps will continue to function and to develop at least  $\frac{1}{2}$  of their previous clamping grip on the track rail.
- (112) If a crane or hoist has 2 or more rail clamps, they shall function simultaneously, and the clamping grip of each on its rail shall be directly proportional to the amount of wind or other loading the clamp is required to resist.
- (113) If the weight of any crane or hoist exceeds 100 tons, the rail clamps shall have an approved safety device that will effectively prevent them from being opened or relaxed while the velocity of the wind exceeds 30 miles per hour in the vicinity of the crane or hoist, and in any direction in which it may travel.
- (114) The rail clamps shall be located in positions in which their sudden application is least detrimental to the stability of the crane or hoist.
- (115) Permanent end stops shall be provided to ensure that travelling cranes or hoists or scaffoldings or any travelling parts of them do not overrun or otherwise exceed their limits of safe travel.
- (116) If the speed of travel of the crane or hoist or relevant part of it exceeds 350 feet per minute, or if the product of its weight in tons and its speed of travel in feet per minute is greater than 3 500, the end stops shall have approved spring or fluid buffers.
- (117) If the weight of the crane or hoist or relevant part of it exceeds 50 tons, the end stops shall be so devised that should

collision occur with them at the maximum speed that may be attained in any circumstances, the crane, or hoist or relevant part of it will not overturn, and will be brought steadily to rest.

- (118) If a crane, hoist or scaffolding or any travelling part of it travels on 2 or more tracks or rails, end stops shall be provided at and in relation to each track or rail.
- (119) No travelling crane or hoist or travelling part of it shall be operated or driven or travelling scaffolding used unless all the end stops are in place, or unless approved effective temporary end stops are in place instead of them.
- (120) Except if running in the bosoms of rolled steel joists, channels, tubes, tees, or angles, all track wheels of cranes or hoists or travelling parts of them shall have flanges at each side of each rail or track on which they run.
- (121) Alternatively, approved means shall be employed for locating and retaining the wheels on their rails or tracks.
- (122) However, a wheel running on twin rails or tracks may have 1 or more central flanges, and the wheels of locomotive cranes or railway type trucks or bogies need not have double flanges.
- (123) If a crane or hoist or scaffolding travels on uneven or slightly uneven tracks or surfaces on track or road wheels that are not fully sprung or alternatively shod in an approved way with pneumatic tyres, it shall be designed as though any 1 wheel, or group of wheels if they are arranged in groups, does not carry load.
- (124) The counterbalance and dead loading of a crane or hoist shall be so arranged and disposed that distortion of the frame structure is minimised.
- (125) Jacks used for supporting, levelling, or stabilising cranes or hoists or scaffolding or plant shall have dynamically irreversible screw threads

or other approved devices by which can be applied and finely adjusted.

- (126) The jacks shall be so braced or otherwise secured in position that they cannot overturn or become in any way displaced.
- (127) If the load plate or instruction plate of any crane or hoist or plant prescribes or indicates that jacks shall be used, the jacks shall accordingly be used.
- (128) If the plates prescribe or indicate further conditions about the way of use of the jacks, the conditions shall be fully complied with.
- (129) The jibhead sheaves and the jibheads of mobile, caterpillar or walking cranes shall be so designed that if the vertical fall of hoisting rope is diverted or displaced laterally  $15^{\circ}$  or more from the vertical it will be automatically unshipped from the jibhead sheave immediately hoisting starts.
- (130) If the hoisting motion of a crane or hoist of the following type has a brake (other than an approved Weston screw or helix type automatic brake) the hand crank handles shall have a neutral position into which they shall be placed and kept completely disconnected from the hoisting mechanism while any load is being lowered under the control of the brake:
- (a) hand-operated winches; or
  - (b) crabs having hand cranks; or
  - (c) hand-operated derrick cranes.
- (131) Subject to section 135 (3) and (4), the specified motions of the undermentioned cranes, hoists and scaffolding, shall, if under power, have approved limiting devices by which overwinding, overluffing, overslewing and overtravelling shall be obviated.

**Part 11** Basic requirements about design and construction, erection, use, maintenance, inspection and testing with particular reference to cranes, lifts, hoists, scaffolding and plant

Section 127

---

- (132) The devices shall effectively prevent the crane, hoist or scaffolding or relevant part of it, or the load, from colliding with or being drawn or forced into contact with any relatively fixed part or object.
- (133) If the platform, cage, box, yoke, lifting hook or analogous media of the cranes or hoists mentioned in subsection (134) (a), (c) and (d) cannot be lowered to the level of the lowest floor or surface served by them without unwinding the hoisting rope, chain, rack, thread or other agency to an unsafe or undesirable degree, limiting devices mentioned in subsections (131) and (132) shall also be provided to obviate the unwinding.
- (134) However, if the chief inspector is satisfied that such collision or contact or unwinding will not damage the crane, hoist or scaffolding, or part of it, or be in any way dangerous, the chief inspector may waive the following requirements of subsections (131) to (133):
- (a) the hoisting motions of overhead traveller cranes;
  - (b) the hoisting and luffing motions of all mobile or caterpillar jib or derrick cranes;
  - (c) the hoisting motions of hoists other than those used in building work, excavation work, or demolition work, for handling materials;
  - (d) the hoisting motions of stacking machines;
  - (e) the hoisting motions of fork-lift trucks including those equipped with trays, scoops, arms or jibs, or other media by which loads are handled;
  - (f) the slewing motions of mobile cranes—
    - (i) if continuous unidirectional slewing is not provided; or
    - (ii) if the crane has not been designed for use with the jib or derrick in all positions.

- (135) Limit devices shall be self-resetting and shall be so devised that on their functioning, the mechanism, or motion they control will be brought to rest and remain safely at rest.
- (136) Power hoists for raising or lowering workers or for raising or lowering loads above workers in confined or partly confined areas shall have approved limiting devices as mentioned in subsection (131) to obviate both overwinding and overlowering, and all dangers attendant on them.
- (137) If any member of a crane or hoist or scaffolding is moved under power by a screw thread or rack, an approved limiting device shall be provided to prevent the thread or rack from being completely unwound from its nut or pinion.
- (138) If any crane, hoist, lift or scaffolding or part of it travels in any direction under power, and if the tractive or propulsive force is applied by any means other than the fractional adhesion of track wheels to track rails, a clearance of approved magnitude and extent shall be provided and maintained at and beyond each limit of travel as a safeguard against overrunning and consequent overloading, and to ensure the effective operation of the limiting devices prescribed by subsections (131) to (137).
- (139) Instead of the overrunning clearances, effective alternative devices may, if specifically approved by the chief inspector, be employed for the purposes aforesaid.
- (140) Except as prescribed by subsection (129), approved means, other than fixed guards, shall be provided to prevent ropes or chains from slackening on, or becoming displaced from or on their drums, sheaves, or other winding media.
- (141) If a crane, hoist, lift, scaffolding, or plant is driven by power and is of the following type, such means shall be so devised, and constructed that slackening of the rope or chain will automatically, and

immediately, cause the drum, sheave or other winding medium to stop with the brake fully applied:

- (a) automatic or semiautomatic hoists having moving platforms, cages, boxes, hoppers, cradles, skips, kibbles, buckets, vessels, tines, monkeys, or yokes;
  - (b) lifts;
  - (c) stacking machines.
- (142) However, if the chief inspector is satisfied that the crane, hoist, lift or scaffolding, or plant is so devised, constructed and enclosed that absence of the safeguards required by subsection (141) would not result in danger to any person, the chief inspector may waive the requirements.
- (143) Hoists used in building work, excavation work, and compressed air work for raising or lowering workers, shall have detaching safety bells, or other approved devices by which in the event of the lifting cage, car, or vessel overrunning and closely approaching collision with the overhead structure the hoisting rope or chain will be automatically and instantly disconnected from the cage, car or vessel, and by which the cage, car, or vessel will remain safely suspended independently of the safety gear prescribed by subsections (96) and (97).
- (144) Hoisting ropes or chains disconnected as prescribed by subsection (143) shall be so guided and arranged that they can be wound freely back by and to their tractive mechanisms without danger and without fouling headbeams, sheaves, projections, or neighbouring buildings, structures, or plant.
- (145) No uncommon device, extra, or innovation capable of affecting ordinary, normal, or customary functioning shall be added to or incorporated in any member, component, part or attachment of any

machinery, mechanisms, or gearing unless approval of the chief inspector has first been obtained in regard to it.

- (146) The slewing motions of caterpillar cranes and hoists shall be locked while the travelling motion is in use.
- (147) Interconnecting mechanisms of cranes, lifts, hoists, scaffolding or plant, shall be so devised and constructed that no motion can become inadvertently engaged or disengaged during operation of any other motion.
- (148) Members, components, parts or attachments of the frame structure of cranes, lifts, hoists or scaffoldings shall not be connected or interconnected by clamps or clamping devices, except if the specific approval of the chief inspector has first been obtained.
- (149) The chief inspector's approval of any clamp or clamping device shall not be deemed to include approval of its general use, but only its use for the purposes and applications that are particularised in the approval.
- (150) If the luffing mechanism of a derrick or jib crane is driven by interconnection with the hoisting mechanism, the crane and mechanism shall be so designed that the working load is luffed in a line that is as nearly horizontal as is practicable.
- (151) In addition the crane and its mechanisms shall be so designed that there will not be any danger of the clutch being driven out of engagement while luffing.
- (152) Fork-lift trucks, or stacking machines, or appliances analogous to them, shall not be equipped or used with jibs capable of lifting or handling loads at greater horizontal radii from the masts of the trucks or machines than those measured horizontally from the masts to the midlength points of the tines, platforms, trays, or scoops with which the trucks or machines would ordinarily be equipped in conformity

with this regulation, unless alternatively, the approval of the chief inspector has first been obtained.

- (153) Approved effective permanent facilities shall be provided by which persons may safely lubricate, tend, and inspect the machinery and other working parts or cranes, lifts, hoists, scaffoldings and plant.
- (154) The facilities shall include approved permanent safe means of access.
- (155) Approved permanent safe means of access shall be provided to the cabins, driving stations, and machinery houses of all cranes, hoists, scaffoldings and plant.
- (156) In order that persons may not be obliged to traverse dangerous zones unnecessarily, access facilities of cranes, hoists, scaffoldings or plant travelling on elevated tracks shall if practicable give access directly to driving cabins, or driving stations.
- (157) A clear unobstructed headroom clearance of not less than 6 feet shall be provided and maintained above the upper surfaces of main access platforms of every crane, hoist, scaffolding or plant that travels under power.
- (158) If secondary platforms function as walkways between other platforms the same headroom clearance shall be provided and maintained above them as above main platforms, or alternatively, the secondary platforms shall be roofed in an approved way.
- (159) Grabs, travelling carriages, or telfers, shall not project over, or otherwise overhang, any access platform, ladder or walkway.
- (160) Access facilities to cranes, lifts, hoists, scaffoldings, building works, excavation works, compressed air works and plant shall be free and shall be kept free of obstruction or partial obstruction, except if partial obstruction is specifically approved by the chief inspector.
- (161) Access facilities shall be so devised, constructed, placed, and fenced that persons using them are safe from injury by machinery, cranes,



lifts, hoists, scaffoldings, plant or loads being handled, or by building or excavation work or compressed air work, or by electricity, explosives, hot or dangerous liquids or substances, gases, vapours or fumes, or by falls or by being crushed.

- (162) The owner or person in charge of any crane that travels under power shall prevent all persons entering on the elevated runway structure of the crane, and no person shall enter on the elevated structure unless, and until, approved effective measures have been taken to ensure the person's safety.
- (163) If an accident has occurred in connection with any crane, lift, hoist, scaffolding, or plant, or in connection with building or excavation work, or compressed air work, or any roof, an inspector may take possession of any part, piece, or item that the inspector considers has been concerned, for close or radiographic examination, analysis or test.
- (164) Alternatively, the inspector may take possession of and preserve the part, piece, or item as an exhibit for production at any coronial inquiry.
- (165) Notwithstanding the provisions of section 4 the peripheral contours of the track wheels of cranes, hoists, scaffolding or plant travelling on railroad type tracks shall conform with diagram 127.



- (167) No crane, lift, hoist or scaffolding shall be constructed in whole or in part of, or include or incorporate, any second-hand material or part.
- (168) However, subsection (167) does not preclude the dismantling and re-erection of the crane, lift, hoist, or scaffolding in accordance with the Act and this regulation.
- (169) Also, second-hand materials may be used—
- (a) if not subject to stress; or
  - (b) if the material is amorphous; or
  - (c) if specifically approved by the chief inspector.
- (170) All enclosed gearings used in connection with cranes, lifts, hoists, and scaffoldings, shall have readily accessible inspection apertures with covers that may be readily removed without dismantling or placing the gearing out of commission.
- (171) The apertures shall be as large as is practicable and shall be so placed that the gearings may be effectively and conveniently inspected.
- (172) Unless otherwise approved all joints within members of the frame or supporting structures of cranes, lifts, hoists, plant, or scaffolding shall be plated with splice plates on all surfaces, but this shall not be necessary if the joint is welded in an approved way.
- (173) If more specific provision is not made in this regulation, and unless the chief inspector otherwise directs, all cranes, hoists, plant and scaffolding and the members, components, parts and attachments of them and to them shall conform with the following Rules of Standards Australia, Crane and Hoist Code No C.B.2, 1938, and the rules shall be interpreted and applied in accordance with the code:

<b>rule No</b>	<b>subject</b>	<b>rule No</b>	<b>subject</b>
317	Concrete-cement, etc	481	Track rail webs

**Part 11** Basic requirements about design and construction, erection, use, maintenance, inspection and testing with particular reference to cranes, lifts, hoists, scaffolding and plant

Section 127

<b>rule No</b>	<b>subject</b>	<b>rule No</b>	<b>subject</b>
319	Welding	482	Track rail clearances
407	Loads—temperature effect	483	Track rail fastening
408	Loads—erection stresses	484	Track rail stops
429	Latticing and plating of struts	486	Runway crane clearances
430*	Struts—minimum lattice bar dimensions	488	Outside crane equipage
431	Struts—angle of lattice bars	501	Grooving for drums and pulleys
432	Struts—batten plates	502	Ungrooved rope drums
434	Struts—spacing of bars and plates	507	Shaft keys, types of
435	Struts—rivets in columns	511	Sheave diameters
437	Effective span of members subject to bending	521	Track wheels, avoid overhang
438	Effective depth of members subject to bending	523	Track wheels, size and depths
444	Strength and ‘Z’ of members subject to bending	524	Track wheels, diameters
445	Strength and ‘Z’ of plate girders	525	Track wheels, tread width
446	Plate girder flange rivets	540	Holding brakes on manual hoists
447	Distribution of wheel loads on plate girders	542	Pressure gauges, visible to driver
448	Plate girder flange section	543	Engine exhausts
449	Plate girder and stiffeners	544	Cylinder drain cocks, etc

<b>rule No</b>	<b>subject</b>	<b>rule No</b>	<b>subject</b>
451	Plate girder stiffeners at loads	548	Controls handy and easy
452	Plate girder stiffeners on both sides of web	811	Drilling
453	Plate girder stiffener proportioning	812	Punching
456	Truss web tension members	813	Reaming
458	Camber of girders and trusses	814	Countersunk rivets
461	Joint splice plate, symmetry of	815	Riveting method
462	Joint splice plate, section of	817	Clearances for bolts
463	Web joints	818	Washers
464	Rivet shearing area	820	Shop painting
466	Rivet minimum pitch	821	Painting of inaccessible parts
467	Rivet maximum pitch	822	Field painting
468	Rivet edge distance	823	Painting, general
469	Rivets through packings	824	Bright or machined surfaces
470	Rivets in tension	825	Surfaces to be concrete protected
471	Rivet gauge lines	1006	No passengers on cranes
472	Rivet effective diameter	1007	Cabin, location, size, etc
473	Drainholes to prevent corrosion	1008	Warning devices
474	Brickwork bearing pressures	1009	Cabin protection in hot places
475	Concrete bearing pressures	1121	Driver, duties on leaving cabin

**Part 11** Basic requirements about design and construction, erection, use, maintenance, inspection and testing with particular reference to cranes, lifts, hoists, scaffolding and plant

Section 127

<b>rule No</b>	<b>subject</b>	<b>rule No</b>	<b>subject</b>
476	Pier tops	1122	Driver must lock crane against wind
477	Bearing pressures, eccentric	1301	Repair authorisation
478	Piles	1302	Repair man, duties before repair
479	Foundations (bearing pressures)	1303	Repair man, to prevent parts falling
480	Track rail sizes		

\* It shall not be necessary to conform with rule 430, par 2.

- (174) Earth, clay, shale, sand, grit, powders, chippings, borings, spalls, punchings, clippings, swarf, offcuts or other aggregates or liquids shall not be used as counter or other balance, bias or operating weights unless encased in accordance with a design first submitted to and approved by the chief inspector.
- (175) Every portable counter, bias, balance or operating weight shall have permanently, clearly and distinctly stamped, engraved or embossed on them, its correct weight in pounds.
- (176) If a weight consists of detachable or demountable sections, each section shall be so marked with its own individual weight, only.
- (177) The figures and letters used in marking weights shall not be less than  $\frac{1}{2}$  an inch in depth.
- (178) No figures other than those stating the weight as mentioned in subsections (175) to (177) shall be marked on any portable weight.
- (179) Live counter, bias, balance or operating weights that are not of metal shall be encased, framed, or otherwise protected or fenced in a way approved by the chief inspector.

- (180) The chief inspector may, if the chief inspector considers appropriate, disallow the use of any such material or the chief inspector may require the use of an appropriate metal instead of it.
- (181) If a portable counter, bias, balance or operating weight has a permanent handle, the handle shall be of round section mild steel of not less than  $\frac{5}{8}$  of an inch in diameter and shall be so devised as to eliminate all corners, vees, or other features that might damage lashings or other ropes used in connection with it.
- (182) Drawings of all portable counter, bias, balance or operating weights that are of concrete, stone or encased materials shall be submitted to the chief inspector for approval before manufacture and the weights shall not be used unless manufactured in accordance with an approved design.
- (183) The thickness of a brake band shall not exceed  $\frac{1}{125}$  part of the diameter of the drum on which it wraps.
- (184) However, no brake band shall exceed  $\frac{1}{2}$  an inch in thickness.
- (185) No transverse fillet weld shall be made on any brake band.
- (186) Single rivets or single bolts shall not be used to connect end fittings to brake bands, or to make joints in brake bands.
- (187) If there is more than 1 row of rivet or other holes in a brake band, the least distance measured obliquely between any hole and the nearest hole that is in another transverse row shall not be less than  $\frac{2}{3}$  of the minimum distance between adjacent holes in any transverse row.
- (188) If brake shoes or brake linings are of timber, only selected timbers of approved types shall be used.
- (189) They shall be fastened in place in an approved way.
- (190) The depth of flanges of break drums, measured radially above braking surfaces, shall not be less than twice the combined thickness of brake band and brake lining.

**Part 11** Basic requirements about design and construction, erection, use, maintenance, inspection and testing with particular reference to cranes, lifts, hoists, scaffolding and plant

Section 127

---

- (191) If the lining consists of wooden blocks, it may for the purpose of fixing flange depths, be deemed to be  $\frac{1}{4}$  of an inch in thickness.
- (192) U-clips attached to brake bands to prevent their lateral displacement from break drums, shall overlap the edges of the drums by a distance at least equal to 3 times the combined thickness of brake band and lining.
- (193) If the lining consists of wooden blocks, it may, for the purpose of fixing the overlap, be deemed to be  $\frac{1}{4}$  of an inch in thickness.
- (194) Aluminium rivets or pegs shall not be used to secure brake linings.
- (195) Brake linings of metal, except approved sintered metal, shall not be used.
- (196) The linings of brake bands shall extend at least to the edges of the bands to which they attach.
- (197) The edges of brake bands, and brake linings, shall be cleanly finished and smooth.
- (198) Leather or combustible fabric brake bands may be used only if specifically approved.
- (199) Closing weights used in solenoid brakes shall not move through a total distance greater than 3 inches unless effectively cushioned to eliminate hammering and impact effects.
- (200) Stops shall be provided to ensure that the shoes of shoe type brakes do not trail on the drums when the brakes are open.
- (201) The angular movement of a pawl about its hinge pin while idling over its mating teeth shall not exceed  $12^{\circ}$ .
- (202) If practicable, pawls shall have springs to accelerate their speed of engagement.
- (203) The springs shall be of approved design.



- (204) Pawls shall not have devices for locking them in engaged or disengaged positions.
- (205) However, subsection (204) does not prevent the use of approved interlocking devices.
- (206) If a pawl has attached to it an operating grip, handle, or trigger, the attachment shall be so devised, and located that it may be safely used.
- (207) Apparatus including the grips, handles and triggers as mentioned in subsection (206) for disengaging and holding pawls in the disengaged position shall be devised and arranged to be actuated by a person located at the driving or operating position of the mechanism or machinery concerned.
- (208) The pawl disengaging and holding apparatus shall not be actuated by foot, but shall comprise a simple hand mechanism.
- (209) It shall be so devised and arranged that it will, when suitably actuated, return the pawl to the engaged position by reliable and effective means.
- (210) It shall be so devised and located that it shall not be necessary for a person to stoop or relax his or her grip on any crank handle while actuating the pawl mechanism.
- (211) Pawls shall be so designed that their active extremities alone, make contact with the mating teeth.
- (212) Pawls or the teeth with which they engage (or both) shall be so designed that the pawls tend to lock in engagement and so that the load holds the pawl in engagement.
- (213) The angle contained between the 2 lines joining the tip of a pawl to the respective centres of rotation of the pawl and its mating teeth shall not be less than 105° and not more than 120°.
- (214) If the pawl is used in tension, the angle contained between the 2 lines joining the tip of the engaged tooth of the ratchet and the centres

mentioned in subsection (213) shall not be less than 60° or more than 75°.

- (215) Gravity operated pawls shall be so balanced that if released while disengaged, they will immediately and automatically re-engage with their mating teeth.
- (216) Safety non-splintering glass or non-splintering non-inflammable plastic shall be used in all transparent wind or weather screens of driving stations, if liable to be struck by loads or by slings, hooks or other lifting media.
- (217) Petrol and other inflammable liquids shall be stored in robust metal tanks having screwed filling plugs and screw-down outlet valves.
- (218) The tanks shall be so located that they are not subject to undue heating, and all desirable provision shall be made to ensure that fumes do not become ignited and do not accumulate.
- (219) Tanks shall be well clear of all electrified wirings, switchgear, control gear and apparatus.
- (220) If practicable inflammable liquid tanks shall be located on the outer sides of driving stations.
- (221) They shall not be closely adjacent to access facilities.
- (222) If cranes, lifts, hoists, scaffolding or plant having internal-combustion engines are required to operate indoors or in confined or poorly ventilated places, effective means shall be taken to remove all exhaust gases and to ensure all desirable ventilation.
- (223) Exhaust steam, hot water, and the exhaust gases from internal-combustion engines, shall be effectively conveyed and directed away from driving stations and from crane and hoist crews.
- (224) If any jib or derrick crane or hoist is not designed to lift its maximum safe working load at all attainable positions of the jib or derrick without breach of the provisions of this regulation, it shall have an

approved load-radius indicator, and the indicator shall be constantly maintained in good working order and condition.

- (225) The load-radius indicator previously mentioned shall function automatically, and be so devised and constructed that for each position in which the jib or derrick may be placed, it exhibits and indicates clearly and conspicuously to the crane driver at the main driving station of the crane the safe working load corresponding to the position, determined in accordance with this regulation.
- (226) The load markings on a load-radius indicator shall be of a permanent nature, and it shall be an offence to obliterate or to incorrectly mark or incorrectly graduate, the indicator, or to so alter the indicator that it reads or indicates incorrectly.

## **Stability**

### **128**

- (1) Every crane and hoist shall have and at all times retain at least the ratios of stability against overturning shown in table 128 as appropriate to its type, and to the loadings acting on it.
- (2) If more than 1 such ratio is shown, the stability shall be separately assessed with regard to each set of contributing circumstances.

**Part 11**

Basic requirements about design and construction, erection, use, maintenance, inspection and testing with particular reference to cranes, lifts, hoists, scaffolding and plant

## Section 128

**Table 128**

type of crane or hoist	ref	live loads exclusive of wind load but inclusive of horizontal forces	dead loads	wind loads in accordance with section 123		1 load equal to 30% of working load—acting vertically upwards at point of application of working load	ratio of stability— minimum
				crane or hoist assumed in operation	crane or hoist assumed not in operation		
stationary crane or hoist or any travelling crane or hoist other than undermentioned	A	{ include	include	include	..	omit	1.3
		{ omit	include	omit	omit	omit	1.8
		{ omit	include	..	include	omit	1.5

type of crane or hoist	ref	live loads exclusive of wind load but inclusive of horizontal forces	dead loads	wind loads in accordance with section 123		1 load equal to 30% of working load—acting vertically upwards at point of application of working load	ratio of stability— minimum
				crane or hoist assumed in operation	crane or hoist assumed not in operation		
travelling slewing cranes and tower slewing cranes	B	include	include	omit	omit	omit	1.3
		include	include	include	..	omit	1.0
		omit	include	omit	omit	omit	1.4
		omit	include	omit	omit	include	1.0
		omit	include	..	include wind acting from the rear.	omit	1.5
		omit	include	..	include wind acting from front or from side	omit	1.0

**Part 11** Basic requirements about design and construction, erection, use, maintenance, inspection and testing with particular reference to cranes, lifts, hoists, scaffolding and plant

Section 128

type of crane or hoist	ref	live loads exclusive of wind load but inclusive of horizontal forces	dead loads	wind loads in accordance with section 123		1 load equal to 30% of working load—acting vertically upwards at point of application of working load	ratio of stability—minimum												
				crane or hoist assumed in operation	crane or hoist assumed not in operation														
		repeat all shown for <i>stationary cranes</i> and add—																	
floating cranes	C	<table border="0"> <tr> <td rowspan="2" style="font-size: 2em; vertical-align: middle;">{</td> <td>include</td> </tr> <tr> <td>omit</td> </tr> </table>	{	include	omit	<table border="0"> <tr> <td>include</td> </tr> <tr> <td>include</td> </tr> </table>	include	include	<table border="0"> <tr> <td>..</td> </tr> <tr> <td>..</td> </tr> </table>	..	..	<table border="0"> <tr> <td>include</td> </tr> <tr> <td>include</td> </tr> </table>	include	include	<table border="0"> <tr> <td>omit</td> </tr> <tr> <td>omit</td> </tr> </table>	omit	omit	}	crane must maintain at least 1 foot of freeboard under these conditions
{	include																		
	omit																		
include																			
include																			
..																			
..																			
include																			
include																			
omit																			
omit																			

Reference B includes cranes travelling on horizontal, level tracks, without superelevation. If these conditions are not ensured, full allowance must be made for more adverse circumstances.

- (3) The ratio of stability of any crane or hoist shall be determined in each instance by dividing the moment of the loadings that stabilise the crane or hoist by the moment of the loadings that tend to overturn it, all the moments being measured about the point or line around which overturning takes place.
- (4) In assessing the overturning loadings, the provisions of section 125 shall be disregarded.
- (5) Unless and until approved by the chief inspector, rail clamps, outriggers or other devices for augmenting the stability of cranes or hoists shall be disregarded in assessing overturning moments.
- (6) If the dead load of any crane or hoist is insufficient to prevent the crane or hoist being blown along its tracks with all track wheels locked, or if the brakes are incapable of completely locking all the track wheels, approved means shall be adopted by which the crane or hoist may be secured against wind loadings.
- (7) In assessing the braking grip of wheels on track rails a coefficient of friction not greater than 0.1 shall be assumed.
- (8) Wind loadings in accordance with section 123 shall be assumed, but irrespective of whether the crane is in operation or not, the intensity of wind loading shall be assumed to be that appropriate when the crane is not operating.

## Test loads

### 129

- (1) Except if the chief inspector otherwise requires, each test load shall weigh  $1\frac{1}{4}$  times the working load of the crane, hoist or part of it that is to be tested.
- (2) No person shall apply any greater test load unless the person has first obtained the assent of the chief inspector.

- Part 11** Basic requirements about design and construction, erection, use, maintenance, inspection and testing with particular reference to cranes, lifts, hoists, scaffolding and plant

Section 130

---

- (3) Not more than 1 test load shall be raised, lowered or transported by or on any crane or hoist or lift or scaffolding at any 1 time.
- (4) If a greater number of simultaneous test loads are necessary the approval of the chief inspector shall be obtained before the loads are raised, lowered or transported.

## Mechanical

### 130

- (1) The diameter of the shank of any forged steel lifting hook shall not, when measured at the bottom of the thread, be less than that determined by the formula—

$$t = 0.65\sqrt{w} \text{ inches.}$$

- (2) In subsection (1):

*t* means the diameter of the hook shank in inches.

*w* means the maximum tensile load in tons in the hook shank.

- (3) For subsection (1) the increases in load *w* otherwise prescribed by section 125 may be disregarded, except if the hoisting mechanism of the crane is within classification 4, in which case the compensating ratio shall be assumed to be 1.2, and the hook designed for the increased load.
- (4) If the shank of a lifting hook is not provided with a screw thread, the hook shall be proportioned as though it were so provided, but if instead of a screw thread the shank is recessed in an approved way to accommodate a split washer or cone, the tensile stress at the recessed part may exceed that permissible if a screw thread were used in the ratio 1.67:1.
- (5) Upset heads shall not be formed on hook shanks after the shanks have been inserted in their trunnions, shackles, swivels or other supports.



- (6) Notwithstanding the provisions of section 4, no lifting hook shall be of less computed strength than one of forged steel proportioned in accordance with diagram 130.1 and diagram 130.2, having regard to the bight diameter,  $C$ , which shall be determined from the formula—

$$C = 1.84\sqrt{w}$$

for hooks for loads not greater than 3<sup>1</sup>/<sub>2</sub> tons, or

$$C = 1.5\sqrt{w}$$

for hooks for greater loads.

- (7) In subsection (6):

$w$ —see subsection (2).



Diagram 130.2

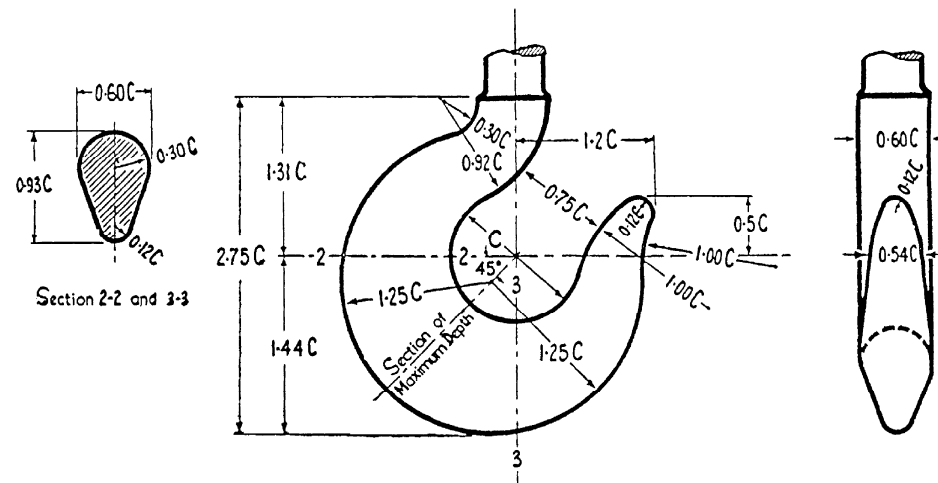

Proportions of forged steel lifting hooks for loads greater than three and one-half tons.

**Part 11** Basic requirements about design and construction, erection, use, maintenance, inspection and testing with particular reference to cranes, lifts, hoists, scaffolding and plant

Section 130

- (8) Except as may be provided in the following subsections, all lifting hooks shall be precisely of the form defined by diagram 130.1 and diagram 130.2.
- (9) Ramshorn lifting hooks shall be precisely of the form defined by diagram 130.3.
- (10) No ramshorn hook shall be of less computed strength than one of forged steel, proportioned in accordance with diagram 130.3, having regard to the shank throat diameter  $t$ , which shall be measured at the bottom of the thread.

**Diagram 130.3**

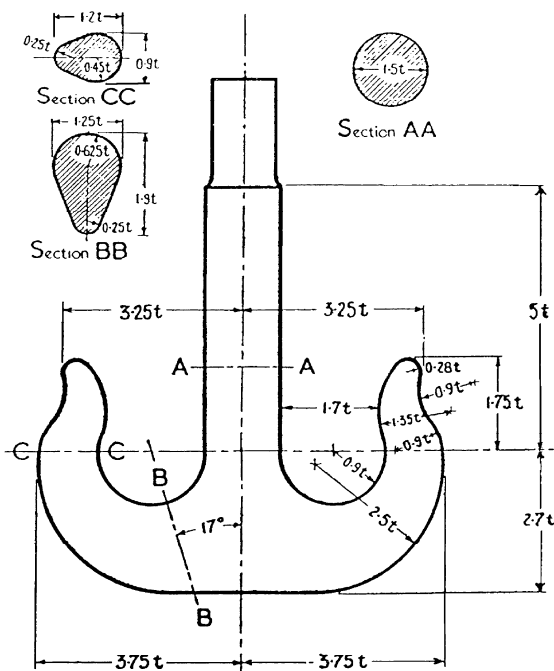

Proportions of ramshorn type forged steel lifting hooks.

- (11) The stress in any rope drum shall be determined from the formula—

$$\sqrt{f^2 + \left(\frac{T}{pt}\right)^2} \text{ pounds per square inch.}$$

- (12) In subsection (11):

*f* means the maximum transverse stress in pounds per square inch.

*p* means the pitch of the rope grooves or least distance measured centre to centre between adjacent turns of rope on the drum.

*t* means the radial thickness of the drum.

*T* means the maximum tensile load in any 1 rope winding on the drum, in pounds.

- (13) For grooved drums *t* shall be measured at the bottom of the grooves; *p* and *t* shall be measured in inches.

- (14) The stress so determined shall not exceed—

- (a) 4 800 pounds per square inch for cast iron drums; or
- (b) 9 600 pounds per square inch for cast steel drums; or
- (c) 12 000 pounds per square inch for mild steel drums.

- (15) In determining the stresses in a rope drum it shall not be necessary to increase the forces or moments producing the stresses in the ratios otherwise prescribed by section 125.

- (16) If a metal shaft of circular section is subject to simultaneous transverse and torsional stresses the resultant shearing stress shall be determined by the formula—

$$\frac{\sqrt{f^2 + 4fs^2}}{2} \text{ tons per square inch.}$$

(17) In subsection (16):

*f* means the maximum transverse stress at the section under consideration.

*fs* means the maximum torsional stress at the same section.

(18) If a metal shaft of circular section is subject to simultaneous transverse and torsional stresses the resultant tensile stress shall be determined by the formula—

$$0.375f + 0.625\sqrt{f^2 + 4fs^2} \text{ tons per square inch.}$$

(19) In subsection (18):

*f*—see subsection (17).

*fs*—see subsection (17).

(20) The computed linear deflection of a metal shaft shall not exceed  $\frac{1}{1200}$  part of the span of the shaft.

(21) If the shaft functions as a cantilever, the deflection shall not exceed  $\frac{1}{600}$  part of the length of the cantilever.

(22) For the purpose of computing linear deflections the modulus of elasticity of mild steel shall be deemed to be 13 000 tons per square inch and it shall not be necessary to increase the forces producing deflections in the way otherwise provided by section 125.

(23) If any shaft has a keyway, featherway, or similar recess greater in any sectional dimension than that provided by British Standard Specification No 46, part 1, 1929, or if a shaft is within classification 3 or 4 or is subject to alteration of stress under power and has any keyway, featherway or similar recess, the stress in the shaft shall be considered to be increased thereby in the ratio—

$$\frac{1}{1 - \frac{0.2b}{D} - \frac{1.1d}{D}} .$$

- (24) In subsection (23):
- b* means the breadth.
- d* means the depth of the keyway, featherway or similar recess.
- D** means the diameter of the shaft.
- (25) For subsections (23) and (24), all dimensions must be measured in the same units.
- (26) For the purposes of design only, spur gears that are not within the central  $\frac{1}{3}$  of the span of their supporting shafts, and cantilevered spur gears that are spaced at a greater distance than  $\frac{1}{2}$  of their own face width from the nearest support shall be classified in the next higher group than the mechanisms with which they are integral.
- (27) Spur gears of mechanisms within classification 4 shall not be mounted in positions that would subject them to such restriction.
- (28) If mounted on short heavy shafts and contained in rigid, close-fitting boxings that have been machined by methods ensuring correct alignment and meshing, spur gears with machined teeth may, if running in lubricant and completely protected against entry of foreign matter, be classified in the next lower group than the mechanisms with which they are integral.
- (29) This classification shall apply to spur gears of mechanisms within classifications 2, 3 or 4, and is solely for purpose of design.
- (30) Unless approved by the chief inspector spur, spiral or worm gears having other than machined teeth shall not be used in hoisting or luffing mechanisms within classifications 3 or 4, or in hand or power-operated chain or wire rope lifting blocks.

**Part 11** Basic requirements about design and construction, erection, use, maintenance, inspection and testing with particular reference to cranes, lifts, hoists, scaffolding and plant

Section 130

---

- (31) Notwithstanding the provisions of subsection (38) for purposes of design only, spur, spiral or worm gears used as follows may, if not otherwise in a lower classification, be considered to be within classification 2—
- (a) in travelling or traversing mechanisms of cranes or hoists where promoting or controlling movements in only horizontal paths, and not subject to wind loadings; and
  - (b) in mechanisms driving continuous unidirectional conveyors that are provided with independent automatic devices to prevent reversal.
- (32) Spur teeth that are not machined shall be considered as simple cantilevers, each bearing at its free extremity a tangential bending force equal to the pitch circle load the spur gear is required to transmit, having due regard to the increases prescribed by section 125.
- (33) The stresses so determined shall not exceed the relevant and appropriate maximum prescribed by section 126, and modified by subsection (47).
- (34) If spur teeth are effectively supported by a single shroud extending in height to at least the pitch circle, tooth stresses may be considered to have been thereby reduced by 10%.
- (35) Effective double shrouds of such height may be considered to reduce tooth stresses by 33%.
- (36) These reductions shall not be made if the face of the spur gear concerned exceeds 3 times the circumferential pitch of the teeth for a single shroud, or 5 times the pitch for double shrouds.
- (37) Subject to the same limitations, an effective single shroud extending to the top of the teeth may be considered to reduce tooth stresses by 16%, and effective double shrouds of the same height by 50%.



- (38) Spur gears of the following materials shall not, for the purposes of design, be considered to be in a lower group than classification 2 if machined, or classification 3 if not machined:
- (a) cast metals, other than steel;
  - (b) extruded metals;
  - (c) synthetics, including impregnated fabrics and fibres;
  - (d) leather;
  - (e) timber, including vegetable fibres.

- (39) The transverse stress at the base of a machined straight involute tooth of a plain or helical spur gear shall be determined from the formula—

$$\frac{WP}{FZ} \text{ pounds per square inch.}$$

- (40) In subsection (39):

**F** means the effective face of the spur gear measured in inches parallel to the axis of rotation of the gear.

**P** means the diametral pitch in the diametral plane of rotation.

**W** means the tooth load in pounds as referred to in subsection (45).

**Z** means a coefficient to be obtained from table 130.1, relevant and appropriate to the number of teeth of the gear and to the obliquity of the path of contact of mating teeth from planes tangential to the shortest line joining the centre of rotation of the gear to the like centre of its mating gear.

- (41) If the tooth is machined in accordance with Fellows standard 20° stub proportions, **P** shall be the diametral pitch in the diametral plane of rotation.

**Part 11** Basic requirements about design and construction, erection, use, maintenance, inspection and testing with particular reference to cranes, lifts, hoists, scaffolding and plant

Section 130

(42) The transverse stress determined in accordance with subsection (39) shall not exceed the relevant and appropriate maximum prescribed by section 126 and modified by subsection (47).

**Table 130.1 Coefficients Z relating to teeth of spur gearing**

No of teeth	14½° involute teeth or cycloidal teeth	20° involute teeth	20° involute stub teeth	Fellow's 20° stub teeth of undermentioned nominal diametral pitch							
				4/5	5/7	6/8	7/9	8/10	9/11	10/12	12/14
10	0.176	0.201	0.261								
11	.192	.226	.289								
12	.210	.245	.311	0.302	0.348	0.320	0.314	0.302	0.314	0.292	0.289
13	.223	.264	.324	.318	.361	.336	.332	.317	.327	.308	.302
14	.236	.276	.339	.330	.374	.352	.348	.332	.339	.320	.314
15	.245	.289	.349	.339	.386	.364	.361	.346	.348	.330	.324
16	.255	.295	.360	.348	.396	.374	.370	.355	.354	.340	.333
17	.264	.302	.368	.358	.405	.383	.380	.364	.366	.349	.342
18	.270	.308	.377	.368	.411	.390	.390	.374	.374	.358	.349
19	.277	.314	.386	.374	.414	.398	.398	.383	.380	.364	.355
20	.283	.320	.393	.380	.425	.405	.405	.390	.386	.371	.361
21	.289	.326	.399	.386	.431	.411	.411	.396	.392	.377	.366
22	.292	.330	.404	.391	.436	.417	.417	.402	.397	.382	.371
23	.296	.333	.408	.396	.441	.422	.422	.407	.402	.387	.377
24	.302	.337	.411	.401	.446	.427	.427	.411	.405	.392	.381
25	.305	.340	.416	.405	.449	.432	.432	.417	.409	.396	.386
26	.308	.344	.421	.409	.455	.436	.436	.421	.413	.401	.389
27	.311	.348	.426	.414	.458	.440	.440	.425	.417	.405	.392
28	.314	.352	.430	.417	.461	.443	.444	.427	.421	.409	.396
29	.316	.355	.434	.421	.465	.446	.448	.430	.424	.412	.399
30	.318	.358	.437	.425	.468	.449	.452	.433	.427	.415	.402
32	.322	.364	.443	.430	.471	.455	.458	.440	.431	.419	.408
33	.324	.367	.445	.432	.474	.458	.460	.443	.432	.422	.411

No of teeth	14½° involute teeth or cycloidal teeth	20° involute teeth	20° involute stub teeth	Fellow's 20° stub teeth of undermentioned nominal diametral pitch							
				4/5	5/7	6/8	7/9	8/10	9/11	10/12	12/14
35	.327	.373	.449	.436	.480	.463	.465	.449	.438	.427	.415
37	.330	.380	.454	.440	.484	.468	.468	.453	.442	.433	.419
39	.335	.386	.457	.443	.488	.471	.472	.456	.445	.438	.423
40	.336	.389	.459	.446	.490	.475	.474	.458	.446	.440	.425
45	.340	.399	.468	.455	.500	.484	.484	.464	.455	.446	.433
50	.346	.408	.474	.461	.506	.490	.490	.471	.461	.452	.439
55	.352	.415	.480	.465	.510	.495	.496	.477	.467	.458	.444
60	.355	.421	.484	.471	.515	.500	.500	.483	.471	.465	.449
65	.358	.425	.488	.476	.518	.503	.503	.487	.474	.468	.452
70	.360	.429	.493	.480	.521	.506	.506	.490	.477	.471	.455
75	.361	.433	.496	.484	.525	.509	.509	.493	.480	.474	.458
80	.363	.436	.499	.488	.528	.512	.512	.496	.483	.477	.461
90	.366	.442	.503	.492	.532	.517	.516	.499	.487	.481	.466
100	.368	.446	.506	.496	.536	.521	.521	.503	.490	.484	.471
150	.375	.458	.518	.509	.546	.534	.531	.515	.503	.496	.484
200	.378	.463	.524	.515	.553	.540	.536	.521	.509	.503	.509
300	.382	.471	.534								
Rack	.390	.484	.550	.543	.578	.562	.553	.540	.534	.528	.521

- (43) The strength of the 'straight' type involute tooth of a bevel spur gear shall be deemed to be less than that of the tooth of a plain spur gear of the same material, diametral pitch, pitch diameter, face, and number of teeth, in the ratio—

$$\frac{\text{diameter of least pitch circle of bevel gear}}{\text{diameter of greatest pitch circle of same spur gear.}}$$

**Part 11** Basic requirements about design and construction, erection, use, maintenance, inspection and testing with particular reference to cranes, lifts, hoists, scaffolding and plant

Section 130

---

- (44) The strength of the involute tooth of a worm wheel shall be deemed equal to that of a plain spur gear of the same material, diametral pitch, pitch diameter, face, and number of teeth.
- (45) Except if the chief inspector otherwise approves, each tooth of a spur gear shall be considered to bear a load equal to the pitch circle load the spur gear is required to transmit, having due regard to the increases prescribed by section 125.
- (46) Alternatively to the method prescribed by section 130 (39) the strength of the machined straight involute tooth of a plain or helical spur gear may be determined by the procedure prescribed by British Standard Specification No 436-1940, 'Machine Cut Gears, Helical and Straight Spur', provided that the approval of the chief inspector is first obtained in relation to all allowances to be made and margins to be preserved.
- (47) To make allowance for dynamic effects the limiting permissible stresses prescribed by section 126 shall for power-driven gear teeth be further reduced in the ratio—

$$\begin{array}{ccc} 600 & \text{for metallic teeth, or} & 200 + \frac{V}{4} \\ 600 + V & & 200 + V \end{array} \quad \text{for nonmetallic teeth}$$

- (48) In subregulation (47):  
 $V$  means the speed of meshing of the gear teeth measured at their pitch circle in feet per minute.
- (49) For the purpose of determining pressures on lubricated bearing journals or surfaces between which relative movement occurs, the force and moment increases prescribed by section 125 may be disregarded.

- (50) The maximum intensity of bearing pressure between a gunmetal bush or bearing and the plain parallel journal of a mild steel shaft revolving relatively to it, and being a machine shaft of the mechanism of a crane or hoist, or lift or scaffolding, shall not exceed that recommended by Standards Australia Crane and Hoist Code No CB2-1938, rule 510 as appropriate and relevant to the use, speed, clearances and system or conditions of lubrication of the bearing.
- (51) The maximum intensities of bearing pressures between other lubricated journals or surfaces shall not exceed those shown in table 130.2, relevant and appropriate to the rubbing speeds, materials and conditions or way of use.

**Notes referring to tables**

Intermediate values may be interpolated—

- \* Maximum permissible pressures at higher speeds shall not exceed those prescribed for 2 inch diameter shafts by Standards Australia Crane & Hoist Code No C.B.2—1938, rule 510.
- ‡ Maximum permissible pressures at higher speeds shall not exceed by more than 25% those prescribed for 2 inch diameter shafts by Standards Australia Crane & Hoist Code No C.B. 2—1938, rule 510.
- § Maximum permissible pressures at higher speeds shall not exceed by more than 15% those prescribed for 2 inch diameter shafts by Standards Australia Crane & Hoist Code No C.B. 2—1938, rule 510.
- † Maximum permissible pressures at higher speeds shall not exceed by more than 45% those prescribed for 2 inch diameter shafts by Standards Australia Crane & Hoist Code No C.B. 2—1938, rule 510.

M.S. means mild steel

Med. S. means steel having a surface hardness of not less than 200 Brinell.

H.S. means steel having a surface hardness of not less than 550 Brinell.

C.S. means mild cast steel.

G.M. means gunmetal.

W.M. means white metal

P.B. means phosphor bronze having a surface hardness not less than 190 Brinell.

C.I. means cast iron.

**Part 11**

Basic requirements about design and construction, erection, use, maintenance, inspection and testing with particular reference to cranes, lifts, hoists, scaffolding and plant

Section 130

**Table 130.2 Maximum permissible intensities of bearing pressures for plain parallel lubricated bearings, in pounds per square inch (if more specific provision is not made elsewhere in this regulation)**

type of Bearing	material in		maximum rubbing speed of journal on bush or bearing in feet/min														note	
	journal	bush or bearing	6	10	20	30	40	50	60	80	100	150	300	400	500	1 500		
sheave pins, track wheel axles, winding drum spindles, pivots, jib hinges, trunnions, and other plain parallel bearings analogous thereto	M.S.	M.S.	1 800	800	200	100	...	...	...	...	...	...	...	...	...	...	...	pressures given are for intermittent running
	M.S.	H.S.	2 200	1 400	800	450	...	200	...	100	...	...	...	...	...	...	...	
	M.S.	C.I.	2 600	2 000	1 250	850	650	500	...	...	300	...	100	...	...	...	15	
	M.S.M	G.M.	4 000	3 600	2 800	2 200	1 700	...	1 100	700	...	...	*260	...	...	...	...	
	.S.	W.M.	4 000	3 750	3 150	2 600	2 100	1 750	1 350	900	700	‡480	...	...	...	...	...	

Basic requirements about design and construction, erection, use, maintenance, inspection and testing with particular reference to cranes, lifts, hoists, scaffolding and plant

Part 11

Section 130

type of Bearing	material in		maximum rubbing speed of journal on bush or bearing in feet/min														note
	journal	bush or bearing	6	10	20	30	40	50	60	80	100	150	300	400	500	1 500	
sheave pins, track wheel axles, winding drum spindles, pivots, jib hinges, trunnions, and other plain parallel bearings analogous thereto	M.S.	M.S.	3 000	...	...	...	...	...	...	...	...	...	...	...	...	...	pressures given are for intermittent running
	H.S.	H.S.	7 000	5 300	4 300	3 750	3 350	3 100	2 900	2 600	2 400	2 000	1 150	...	0	...	
	H.S.	C.I.	5 000	3 600	2 700	2 250	2 000	...	1 750	...	1 400	1 100	400	0	...	...	
	H.S.	P.B. or W.M.	6 000	5 650	4 900	4 400	4 000	3 650	3 400	3 000	2 800	2 500	2 230	...	...	50	
	Med.S.	C.I.	3 120	2 400	1 500	1 020	780	600	...	...	360	...	120	...	...	20	pressures given are for intermittent running
	Med.S.	W.M.	4 600	4 300	3 620	2 990	2 410	2 010	1 550	1 035	800	†550	...	...	...	...	
	Med.S.	P.B.	4 600	4 140	3 220	2 530	1 960	...	1 265	800	...	...	\$300	...	...	...	
	C.I.	C.I.	1 800	1 500	1 000	700	500	400	350	...	300	...	100	...	...	15	pressures given are for intermittent running
	C.I.	G.M.	...	500	...	...	...	...	...	300	...	...	100	...	...	15	
	C.I.	W.M.	3 500	2 750	1 900	1 500	1 200	1 000	800	600	*450	...	...	...	...	...	

**Part 11** Basic requirements about design and construction, erection, use, maintenance, inspection and testing with particular reference to cranes, lifts, hoists, scaffolding and plant

Section 130

(52) The maximum intensities of bearing pressures between the surfaces of lubricated plain thrust bearings shall not exceed those shown in table 130.3, relevant and appropriate to the rubbing speeds, materials and way of use.

**Table 130.3 Maximum permissible intensities of bearing pressures for lubricated plain thrust bearings, in pounds per square inch (if more specific provision is not made elsewhere in this regulation). Intermediate values may be interpolated**

materials in contact	maximum peripheral rubbing speed in feet/min—								note
	10	20	40	80	100	150	200	500	
M.S. on G.M.	1 500	850	320	110	100	80	60	50	Pressures given are for intermittent running
M.S. on W.M.	1 800	1 100	460	170	160	150	120	100	
Med.S. on P.B.	2 500	1 650	750	170	165	155	145	80	
Med.S. on W.S.	2 500	1 880	1 000	300	200	190	180	110	
H.S. on P.B. or H.S. on W.M. }	4 000	2 600	1 500	600	500	460	410	150	
	750	400	110	60	50	40	30	10	

(53) The maximum intensities of bearing pressures between lubricated plain sliding surfaces shall not exceed those shown in table 130.4, relevant and appropriate to the rubbing speeds, materials and way of use.

**Table 130.4 Maximum permissible intensities of bearing pressures for lubricated plain sliding surfaces, in pounds per square inch (if**



**more specific provision is not made elsewhere in this regulation). Intermediate values may be interpolated**

materials in contact	maximun rubbing speed in feet/min—				note
	209	300	1 200	S	
C.I. on C.I. } or C.I. on M.S. }	100	88	49	$\frac{1\ 760}{\sqrt{S + 100}}$ <i>but not more than 100</i>	Pressures given are for continuous but reciprocating motions. The bearing pressure for a unidirectional slide shall not exceed one half of that provided for a corresponding but reciprocating slide
W.M. on C.I.	300	264	147	$\frac{5\ 280}{\sqrt{S + 100}}$ <i>but not more than 300</i>	

(54) If the diameter of the journal is less than 1<sup>1</sup>/<sub>4</sub> inches, the maximum intensity of bearing pressure shall not exceed that obtained by multiplying the pressure shown in table 130.2 by the coefficient shown in table 130.5, appropriate to the diameter of the journal.

**Table 130.5 Reduction coefficients for bearing pressures for lubricated bearings of which the journals are less than 1<sup>1</sup>/<sub>4</sub> inches in diameter**

diameter of journal in inches	coefficient	diameter of journal in inches	coefficient
1.125	0.7	0.5	0.3
1.0	0.5	0.25 or less	0.25
0.75	0.35		

**Part 11** Basic requirements about design and construction, erection, use, maintenance, inspection and testing with particular reference to cranes, lifts, hoists, scaffolding and plant

Section 130

---

- (55) For the purpose of determining loads on hard steel precision ball or roller bearings of at least equal quality to those complying with British Standard Specification No 292—1927, the force and moment increases prescribed by section 125 may be disregarded.
- (56) The basic load of a ball or roller bearing shall not exceed that relevant and appropriate to the particular speed, size, type and construction of bearing, as tabulated for a 500 hours critical test life by an approved ball or roller bearing maker or an approved representative of the maker in an approved catalogue of the maker or representative.
- (57) Approved ball and roller bearing makers and approved catalogues include—
- (a) The S.K.F. Ball Bearing Co., Australia Proprietary Limited, Catalogue having registered number 1203 over A.N. 50; or
  - (b) The Ransome and Marles Bearing Co. Limited, England, Catalogue ‘Publication No 28, August, 1946’; or
  - (c) The Bearing Service Company of Australia Proprietary Limited, Catalogue entitled ‘B.S.C. Engineering Manual’, 2nd Edition, 1951; or
  - (d) Ball Bearings Proprietary Limited, Catalogue entitled ‘Hyatt Roller Bearings’ having registered number D8-8; or
  - (e) G. Vaccari & Company, Melbourne, Catalogue entitled ‘R.I.V. General Catalogue’, serial number 51-03-141A.
- (58) The maximum load on a hard steel precision ball or roller bearing of the quality prescribed by subsection (55) shall not exceed that obtained by dividing the basic load by a life factor of—
- (a) 1.75 if the bearing is within classification 1; or
  - (b) 2.25 if the bearing is within classification 2; or
  - (c) 2.75 if the bearing is within classification 3; or

- (d) 3.5 if the bearing is within classification 4.
- (59) Ball or roller bearings of a lower quality than those conforming with British Standard Specification No 292—1927 shall not be used unless the written approval of the chief inspector is first obtained.
- (60) The bearings shall not be used in contravention of any condition or stipulation made by the chief inspector in the chief inspector's approval.
- (61) The approval of the chief inspector in relation to any maker, or any catalogue of any maker of ball or roller bearings, may be conditional.
- (62) If the outer race of a self-aligning radial ball bearing rotates, the basic load shall be reduced to 90% of the value prescribed by subsection (56).
- (63) If the outer race of any other type of radial bearing rotates the basic load shall be reduced to 75% of the value prescribed by subsection (56).
- (64) Bush roller chains, and other types of parallel or flat link chains, including Renolds, Morse and Coventry types, shall not be loaded beyond  $\frac{1}{5}$  part of that load that would produce a permanent elongation of  $2\frac{1}{2}\%$  of the length of the chain.
- (65) For subsection (64) the increases in applied load prescribed by section 125 may be disregarded, except if the chain is within classification 4, in which case the compensating ratio shall be assumed to be 1.2.
- (66) Because of its lateral inflexibility this type of chain shall not be used as a load chain to suspend loads.

**Part 11** Basic requirements about design and construction, erection, use, maintenance, inspection and testing with particular reference to cranes, lifts, hoists, scaffolding and plant

Section 131

---

## Materials

### 131

- (1) No crane, hoist, lift, scaffolding, or plant, or member, component, part, or attachment of it shall be either in part or in whole of any material, composition or substance, or use or employ any fluid, unless—
- (a) the physical and chemical properties of the material, composition, substance or fluid are shown in, and are in accordance with, a standard specification approved and promulgated by Standards Australia and the use is not disapproved by the chief inspector; and
  - (b) a specification setting out its physical and chemical properties, as well as fully detailed and fully dimensioned drawings showing how it is to be utilised and employed, has first been submitted to the chief inspector and approved by the chief inspector; and
  - (c) the chief inspector has been advised, in writing, of the physical and chemical properties of the material, composition, substance, or fluid, as in the state in which it is to be placed into commission.
- (2) However, the following materials may if not disapproved by the chief inspector, or subject to any more specific provision made elsewhere in this regulation, be deemed to conform with subsection (1):

earth	rubber	salt
clay	timber	air
sand	paper	water
stone	fuels	solvents
brick	lubricants	detergents
vitriified clay	coolants	paints
porcelain	graphite	enamels

---

glass	asphalt	varnishes
asbestos	bitumen	lacquers
leather	tar	

- (3) Stressed timbers of cranes, hoists, lifts, scaffolding and plant shall conform to the requirements of the Australian Standard Grading Rules for sawn and hewn timbers of select grade, Standard Number (E) 0.54—1942.
- (4) Jarrah, karri and wandoo shall conform to the requirements of Australian Standard Grading Rules for such timbers of select grade, Standard Number 0.10 to 45—1948.
- (5) The rules mentioned in subsections (3) and (4) being those promulgated by Standards Australia.
- (6) If sizes or dimensions of timbers or other materials are prescribed or otherwise cited in this regulation, they shall mean actual sizes, as distinct from nominal or reputed sizes.
- (7) Unless otherwise stated all bolts, setbolts, setscrews, tapbolts, screws etc referred to in this regulation shall be of steel.
- (8) Timbers shall not be painted with any opaque or partly opaque paint or preparation, or be encased or enclosed in any way that will obscure the timber or interfere with ready inspection of it.
- (9) If practicable, bolts in timber shall be spaced at staggered pitches.
- (10) If practicable, effective stitch bolts shall be employed transversely to the bolts of all main connections of, or to, timber members.
- (11) If the lower ends of timbers enter metal sockets, adequate drain holes shall be provided.
- (12) The sockets shall be tapered and the timbers shall fit tightly in them.

**Part 11** Basic requirements about design and construction, erection, use, maintenance, inspection and testing with particular reference to cranes, lifts, hoists, scaffolding and plant

Section 131

---

- (13) If metal is to be bolted or otherwise secured to the surface of timber, approved bituminous paper or felt sheeting shall be inserted within and throughout the full area of the joint.
- (14) Bolts passing through timber shall have washers under heads and nuts, except if equivalent metal work renders washers unnecessary.
- (15) Unless otherwise approved, timbers shall be joined by employing simple butt joints only.
- (16) Unfilled holes or notches in timber shall be filled by tightly fitting timber plugs to prevent weathering and decay, and the breaking away of adjoining timber.
- (17) The filling of any hole or notch as mentioned in subsection (16) shall not be deemed to restore or increase the strength or any dimension of the timber.
- (18) No laminated or glued timber shall be employed unless approved, or unless so used that its failure would not be productive or conducive of danger to life or limb.
- (19) Cast iron shall not be used in the following applications or for the following purposes, unless the specified approval of the chief inspector has first been obtained:
  - (a) the foot lugs or jibs or derricks of power cranes of all types, or the jib or derrick supporting lugs of the cranes;
  - (b) soleplates, spiders, or slewing race pinions or slewing racewheels of power derrick or power jib cranes or the brackets carrying slewing race pinions of the cranes;
  - (c) masthead castings of derrick or jib cranes;
  - (d) straight spur gears of chain blocks;
  - (e) main frame or cheek castings of winches used in connection with scaffolding;

- (f) pawls;
  - (g) dog or toothed clutches;
  - (h) cranks or crank handles;
  - (i) hooks or their trunnions or yokes;
  - (j) structural beams or cantilevers, or loadbars or yokes subject to primary transverse stress.
- (20) Diecast metals or alloys shall not be used for any purpose unless specifically approved by the chief inspector.
- (21) All steel castings subject to primary transverse stress shall be radiographically examined by an approved authority, and if defects are observed, the casting concerned shall not be placed into commission unless the chief inspector specifically approves.

## Fencing—general

### 132

- (1) The following members, components, parts or attachments of scaffoldings, cranes, hoists, plant, lifts or gear shall be effectively guarded so that they shall not be dangerous to persons nearby or persons driving, examining, testing, lubricating, tending, cleaning or adjusting the scaffoldings, cranes, hoists, plant, lifts or gear:
- (a) toothed wheels of builders' power hoisting winches;
  - (b) friction wheels of builders' power hoisting winches;
  - (c) toothed wheels of the longitudinal travelling mechanism of power-driven overhead travelling cranes if exposed above or partially above access platforms, access facilities or end carriages;

**Part 11** Basic requirements about design and construction, erection, use, maintenance, inspection and testing with particular reference to cranes, lifts, hoists, scaffolding and plant

Section 132

---

- (d) toothed wheels of locomotive type power cranes and power cranes having an analogous arrangement of machinery if the wheels revolve in close proximity to crane frame structures;
- (e) toothed wheels of, and adjacent to, the mixing vessels of power-driven concrete mixers and like mixers, including positions at which the wheels revolve in close proximity to the frame structures of the mixers;
- (f) those members, components, parts or attachments that are within reach of access facilities, floors, the ground, or other working surfaces and that revolve and are of irregular, radially variable, intermittent, broken or gapped contour or have projecting keys, setscrews, bolt ends, nuts, pins (including split pins), bosses, dogs, lugs, ribs, fins, arms or the like because of which they may directly or indirectly engage the person or clothing.
- (g) ends of revolving shafts, spindles, pins or axles that are within reach and that project more than 2 inches beyond their supports;
- (h) transmission belting and transmission chains that are within reach;
- (i) power-driven revolving shafts, spindles, pins or axles if exposed at or near accessholes, hatchways, doorways, gateways or like facilities, or if exposed in such positions with regard to access facilities that persons are likely to make contact with them;
- (j) power-driven shafts, spindles, pins, axles, drums, couplings, toothed wheels, rollers or the like revolving above the upper surfaces of floors, platforms, walkways, pathways and the like wherever an unobstructed minimum clearance of 2<sup>1</sup>/<sub>2</sub> inches does not at all times exist between the revolving member and the surface;



- (k) power-driven spoked wheels and wheels having web apertures if the wheels revolve in close proximity to the frame structures of cranes, engines or gear;
  - (l) power-driven fans or blowers, including cooling fans of internal-combustion engines;
  - (m) hoods or cowlings that may be readily removed or displaced shall not be deemed to be effective guards;
  - (n) all members, components, parts of attachments liable to attain a temperature in excess of 140° Fahrenheit or that are liable to discharge flame, gas, vapour or liquid exceeding that temperature.
- (2) In subsection (1) (f), ordinary, plain, concentric spur or worm gearing shall not be deemed to be of irregular, radially variable, intermittent, broken or gapped contour.
  - (3) The guards shall be constantly maintained in position in a state of complete effectiveness.
  - (4) If so situated that a person may climb or rest on it each guard shall be capable of sustaining, without permanent distortion, a weight of 170 pounds placed in any position on it, together with a simultaneous force of 50 pounds applied horizontally in the same or any other position.
  - (5) Protruding or projecting levers, handles, rods, links, bolts, spikes, pins, or other members of less than 2 square inches sectional area shall be so guarded or fenced that they will not endanger the eyes of persons in the vicinity.

## **Jointers**

### **132A**

- (1) No jointer that is plant shall be used for overhead planing unless—

- Part 11** Basic requirements about design and construction, erection, use, maintenance, inspection and testing with particular reference to cranes, lifts, hoists, scaffolding and plant

Section 133

---

- (a) it is fitted with a cylindrical cutter block the slots of which are not more than  $\frac{5}{8}$  of an inch in width and not more than  $\frac{7}{16}$  of an inch in depth or are of a greater width or depth that is approved; and
- (b) the edges of the table that form the slot or opening in which the cutter block revolves are kept as close to the block as is possible, consistently with the proper working of the machine.
- (2) In this section:
- jointer* means the woodworking machine commonly known as a jointer, surface planer or buzzer.

## Electrical

### 133

- (1) In this section:
- out of reach* means 8 feet above the nearest floor or other working surface, or object on which a person might reasonably step or stand without climbing. An object may be regarded as out of reach if it is 7 feet above the nearest edge of a floor or working surface, and at the same time displaced 21 inches laterally outwards from the edge, or 6 feet above and 30 inches laterally, or 5 feet above and 40 inches laterally, or 4 feet above and 48 inches laterally.
- (2) Except if provision is made elsewhere in this regulation the electrical wiring and equipment of all cranes, lifts, hoists, scaffolding, plant and gear as also that used in building, excavation and compressed air works shall conform with the S.A.A. Wiring Rules.
- (3) Electrified conductors, terminals, fittings and apparatus within reach of access facilities, floors, platforms or other working surfaces, or stairs or ramps, or stacks of materials or goods on which persons may readily climb, or within reach of any part of any crane, lift, hoist,

scaffolding, or plant, to which the driver or an attendant is liable to resort for the purposes of inspecting, lubricating, or tending, shall be safely enclosed or safely fenced.

- (4) For subsection (3), the dielectric of the conductor, terminal, fitting or apparatus shall not be considered to be a safe enclosure or fence.
- (5) Subsection (3) shall not apply to flexible cords, or, as far as the bridge platforms are concerned, to the bare conductors between or on the bridge beams of overhead traveller cranes.
- (6) Flexible cords shall not, in damp places, be within reach unless boxed or enclosed in an approved way.
- (7) No indoor electrified bare conductor, terminal, fitting or apparatus shall be set at a less distance above ground level, or above the level of any floor, platform or other working surface, or stair or ramp or any readily accessible equipment than 12 feet.
- (8) However, if the type of goods or materials or equipment being handled in the vicinity is such that inadvertent contact might be expected with the electrified members, the distance shall be increased to at least 16 feet.
- (9) If approved, collector wires or conductors may be of steel.
- (10) All parts of electrically operated cranes, hoists, scaffolding and plant that are of metal shall, in earthed situations, be effectively earthed.
- (11) However, subsection (10) shall not necessitate earthing of isolated metal parts of timber appliances if the parts cannot reasonably become electrified.
- (12) Unless fixed in position and free from working movements, earthing conductors shall be flexible.
- (13) All earthing conductors shall be effectively protected against mechanical damage.

**Part 11** Basic requirements about design and construction, erection, use, maintenance, inspection and testing with particular reference to cranes, lifts, hoists, scaffolding and plant

Section 133

---

- (14) Flexible earthing conductors of copper or bronze shall not contain any wire of greater diameter than  $\frac{1}{100}$  part of an inch.
- (15) Each earthing conductor of every iceworks crane or hoist shall be of at least  $\frac{1}{10}$  of 1 square inch in section area, and each crane track rail shall be separately earthed.
- (16) Cranes or hoists used for supporting objects that are being electrically welded shall be effectively earthed with an earthing conductor not less in area than  $\frac{1}{10}$  of 1 square inch.
- (17) Cranes or hoists, other than caterpillar or mobile cranes or hoists, shall not be set up or built or set or placed in position in proximity to any electrified equipment or apparatus unless effective permanent fencing or other approved safeguard has first been provided and fixed to ensure the safety of persons using, or working in connection with, the crane or hoist.
- (18) Caterpillar, mobile or portable cranes, hoists or plant in the proximity of electrified equipment or apparatus shall be effectively earthed in a way that will ensure the safety of persons using or working in connection with the cranes, hoists or plant.
- (19) If cranes or hoists are required, unavoidably, to handle loads in close proximity to electrified conductors, as may occur in the erection of city buildings, all loads shall be controlled by dry tail ropes of fibre or other dielectric material, and thereby prevented from approaching or being blown within 5 feet of any electrified conductor.
- (20) Pendant switches attached to flexible conduit or other flexible supports shall not be employed in damp places.
- (21) Plug sockets for flexible conductors or flexible cords shall be wired identically, so that identical phases will be selected by the pins of the plugs when inserted in different sockets.
- (22) The identity of active and neutral connections shall be preserved in a like way.

- (23) Electrical emergency limiting devices prescribed by section 127 (131) to (135) shall be wired in series with the motors concerned, and shall directly, mechanically and without recourse to relays, interrupt the whole current to it.
- (24) Approved effective permanent facilities shall be provided by which persons may safely inspect, tend and adjust all electrical equipment.
- (25) The facilities shall include approved permanent safe means of access.
- (26) The circuit breakers of cranes, hoists, scaffolding and plant shall be located at the main driving stations of them, closely adjacent to the controls, and shall be so devised and fixed that the driver may, in emergency, instantly open them.
- (27) Manual circuit breakers shall be so devised that if opened by remote push-button or switch they cannot be manually closed, either momentarily or otherwise, until the remote push-button or switch concerned has been manually reset.
- (28) The principal isolating switch of every electric crane or hoist that travels on elevated tracks shall be a simple manually operated series switch and shall be set closely adjacent to the foot of the ladder or stair that gives access to the crane or hoist.
- (29) If access to the crane or hoist is obtained from an adjacent floor or analogous permanent elevated surface, the switch shall be set closely adjacent to the position at which the driver is to embark and disembark.
- (30) The principal isolating switch shall manually isolate all downshop conductors from the incoming supply of electrical current.
- (31) It shall be plainly marked 'Crane Switch' or 'Hoist Switch' according to its purpose, and at least 2 square feet of the immediate background behind the switch shall be painted a distinctive bright yellow colour.

**Part 11** Basic requirements about design and construction, erection, use, maintenance, inspection and testing with particular reference to cranes, lifts, hoists, scaffolding and plant

Section 133

---

- (32) In addition to the isolating switch, emergency push-buttons or switches shall be set not more than 6 feet above the principal floor or floors served and at such positions that the crane or hoist cannot travel a greater distance than 100 feet from its position when immediately adjacent to the nearest emergency switch.
- (33) The emergency switches shall, when operated, isolate all downshop conductors from the incoming supply of electrical current, and shall be so devised that the conductors cannot again be electrified until the emergency switch concerned has been manually reset.
- (34) If the floor served by the crane or hoist is so obstructed that speedy access to all emergency switches is not assured, additional emergency switches shall be fixed so that the distance of travel of the crane or hoist is reduced to 50 feet or to any other distance that the chief inspector may direct.
- (35) The electrical switches and control and protective equipment of each crane, lift, hoist, scaffolding or item of plant shall be clearly and distinctively marked and partitioned off from all other electrical switches and control or protective equipment.
- (36) To avoid interference with access facilities and so that they may be more readily observed by the driver, the downshop conductors supplying electrical energy to any crane or hoist that travels on elevated tracks shall be adjacent to that track that is most remote from the main driving station of the crane or hoist.
- (37) Collectors shall be so devised that downshop or other conductors cannot become displaced from them, and vice versa.
- (38) If static access platforms, other than small platforms provided solely as a means by which persons may embark or disembark, are fixed in connection with any travelling crane, hoist or scaffolding, a simple manually operated series switch shall be provided on the crane, hoist or scaffolding within easy reach of the static platform.

- (39) The switch shall, when opened, isolate the travelling motion of the crane, hoist or scaffolding from the incoming supply of electric current.
- (40) Slots provided in floors, platforms, wharf deckings, or analogous surfaces or in other readily accessible places for electrical collectors of travelling cranes or hoists shall not exceed 1<sup>1</sup>/<sub>2</sub> inches in width.
- (41) The bare conductors under them, or adjacent to them, shall be so placed that they are at least 1<sup>1</sup>/<sub>2</sub> inches clear of any straight rod that may be inserted through the slot.
- (42) Control pendants of electric cranes and hoists shall be so devised and arranged that the person operating them is able to conveniently stand at least 6 feet from the suspended load.
- (43) Markers or yokes suspended on pendant cords shall be of a type and fixed at a height that they will not injure persons who may collide with or be struck by them.
- (44) Downshop and other bare conductors may be supported by and on approved single insulators.
- (45) End straining or tensioning screws shall not be locked or otherwise rigidly attached to their supports, but shall be free to align themselves with the conductors.
- (46) Locknuts, or other locking devices shall be employed but in a way that will permit such freedom.
- (47) If collector wires or conductors of an overhead traveller crane are on a bridge platform of them, the ends and other points of entry to the platform shall be fenced with approved gates, each bearing an approved warning notice.
- (48) Unless an approved safety fence is erected on the platform, no other equipment, mechanism or apparatus that may require inspection or

attention shall be placed on the platform on which collector wires or conductors are located.

- (49) Electrical switch or control or protective gear shall not be placed on the bridge platforms of overhead traveller cranes or of gallows or gantry cranes unless the approval of the chief inspector has first been obtained.
- (50) Switches and controllers actuated by pendants shall be so devised and constructed that in the event of 1 pendant becoming detached, the weight of the other will not prevent the switch or controller returning to the neutral or open position.
- (51) Pendant controls shall not be employed if they may foul or become otherwise jammed or entangled in any obstruction.
- (52) Electric lights and the conductors supplying them with current shall not if used within reach in excavation work, or in earthed situations, be at a higher potential than 32V alternating current or 50V direct current above earth or the earthed situation.
- (53) However, subsection (52) shall not apply if the conductors are in metal conduit and the lights fixed permanently in position.
- (54) Electrified conductors used in building, excavation or compressed air works shall be fixed overhead and if practicable out of reach.
- (55) If within reach, they shall be in metal or approved rubber conduit.
- (56) If it is necessary to lay conductors on or closely adjacent to floors, they shall be in metal conduit.
- (57) Rubber conduit shall in such case be used only in approved circumstances if damage is not to be expected.
- (58) Subsection (54) to (57) shall not prevent the use of approved flexible cords for portable lights, tools and portable plant provided the conductors are of the least reasonable working length that can be used.



- (59) Electrified bare conductors, fittings or apparatus shall not be within reach of windows, openings or edges of floors of other working surfaces at building, demolition, excavation or compressed air works.
- (60) Electrified conductors, fittings and apparatus under wharves shall be effectively fenced for the protection of persons in boats or climbing under the wharves.
- (61) Electrified conductors and apparatus shall at all times be at least 6 feet clear of vessels containing gas under pressure.

### **Stiff-leg derrick cranes**

#### **134**

- (1) The main members of a stiff-leg derrick crane shall be considered to be on its left-hand side if they are to the left of a vertical plane extending through the top and bottom pivots, and passing through a point halfway along a line joining the 2 backstay foot anchorages, the direction of vision being from the last mentioned point towards the pivots.
- (2) In determining which members or parts are on the left, and which on the right-hand side, the jib shall be deemed to be in the plane so defined.
- (3) If 1 backstay of a crane is shorter in length than the other, the shorter stay shall be on the left-hand side of the crane.
- (4) Jibhead bridles shall be of approved fabricated construction or of flexible steel wire rope having in each part or single not less than 6 strands, each containing not less than 19 wires.
- (5) Approved connections shall be made between rope bridles and jibhead pins.
- (6) If any rope is in more than 1 part or single, the loads in the respective parts or singles shall be effectively equalised.

**Part 11** Basic requirements about design and construction, erection, use, maintenance, inspection and testing with particular reference to cranes, lifts, hoists, scaffolding and plant

Section 134

---

- (7) Ropes and their sheaves and bridles shall be so devised and constructed that they do not foul the crane members or parts, or any obstructions, particularly during slewing or luffing.
- (8) The mast bridle collar shall be bolted through the top pivot by means of a tight-fitting bolt.
- (9) The nut of the bolt shall be secured by a split pin.
- (10) All other collars on the top pivot shall be secured in the same way as the mast bridle collar.
- (11) The maximum total 'slack', or combined longitudinal take-up clearance, of all members encircling the top pivot shall not exceed  $\frac{1}{16}$  of an inch.
- (12) The total diametral clearance of any gland on the top pivot or on any sleeper pin, or of any member on an anchorage pin, shall not exceed when worn  $\frac{1.5}{10}$  of an inch.
- (13) Bolts, or pins with nuts, shall be used to secure bridles, and backstays to top pivot fittings.
- (14) The nuts shall be secured with split pins.
- (15) Unless secured by approved locking plates, the pins of all sheaves shall be secured by nuts having split pins.
- (16) Pins securing bottom glands to sleepers or to foundations shall have nuts secured by split pins.
- (17) Race pinions, and their shafts, shall be secured by keep plates in addition to keys or splines.
- (18) Keys or feathers shall not be used in connection with sliding pinions or sliding clutches, unless the keys or feathers are formed as an integral part of, and in 1 piece with, the shaft.
- (19) The soleplates of all derrick cranes shall be effectively fastened down to prevent uplifting.

- (20) Effective positive devices shall be employed to prevent all masts from lifting from their bottom pivots.
- (21) Topmost ends of backstay timbers shall have metal weatherings to exclude moisture.
- (22) Regular inspections shall be made of all members, components, parts and attachments of derrick cranes that shall at all times be kept in good order and condition.
- (23) Particular attention must be given to connections and fastenings, especially if members are of timber.
- (24) In addition to any moving flexible earthing conductor that may be used, electric derrick cranes shall be effectively earthed from the soleplate or other static part of the framework.
- (25) The racewheels and pinions and other parts of the slewing mechanisms shall be kept in such adjustment that lost motion at the jibhead shall not exceed a total of 2 feet, measured horizontally.
- (26) The controls of derrick cranes shall be grouped conveniently at the left-hand side of the main driving station, and the station shall be so devised and constructed that while at the controls the driver has a good view of the load.
- (27) The counterbalance weights of derrick cranes shall be so devised, constructed and attached that they do not subject the backstays or sleepers or pivots to bending actions.
- (28) If the sleepers or backstays of a derrick crane are lashed down, the lashings shall be of a type that may be readily tightened by shortening from time to time without the use of wedges.
- (29) Packings greater in thickness than 3 inches shall not be used under cranes depending on lashings, unless approved.

**Part 11** Basic requirements about design and construction, erection, use, maintenance, inspection and testing with particular reference to cranes, lifts, hoists, scaffolding and plant

Section 135

---

- (30) If derrick cranes are mounted on trucks or bogies, a rigid spar, or other rigid member, shall be secured between the 2 backstay foot trucks or bogies to ensure their correct spacing and relationship.
- (31) Permanent blockings shall be fixed under each truck or bogie, to ensure that in the event of its derailment or axle failure, the crane members will not descend or fall more than 1<sup>1</sup>/<sub>2</sub> inches.

### **Caterpillar cranes and mobile cranes**

#### **135**

- (1) Subject to subsections (3) and (4), if the jib is of the cantilevered type an approved limiting device shall be provided by which overluffing is prevented, and by which, in addition, the jib is prevented from being lowered on the lifting hook or block or analogous medium, or the hook, block or medium from being wound into contact with the jib.
- (2) The limiting device shall be effective and shall be constantly maintained in good working order and condition.
- (3) If the chief inspector so directs, or if it is advisable not to equip any caterpillar or mobile crane with the limiting devices mentioned in subsection (1), or those prescribed by section 127 (131) to (135), the crane shall instead of it be equipped with approved devices by which the loads in the crane ropes or other hoisting or luffing media shall be effectively limited in magnitude to an approved amount.
- (4) Alternatively, the crane shall be so designed and constructed that the loads will be automatically limited as previously mentioned.
- (5) Hydraulic or fluid pressure rams used in connection with hoisting or luffing shall have at their fluid outlet connection a restricting or throttling device that will, in the event of breakage of the pipe conveying fluid, effectively prevent the load, or the jibhead from descending at a greater speed than 100 feet per minute.

- (6) Correctly prepared blocks or approved stops shall be provided by which the elastic action of the road wheel springs may be restricted or eliminated if desirable.
- (7) If necessary or advisable, jacks shall be provided for adjusting the crane chassis to level the jib hinges.
- (8) The jacks shall be complete with all auxiliary equipment necessary or advisable for their safe and effective operation.
- (9) Jacks shall be so devised and constructed that they will strongly resist lateral and longitudinal movements of the crane.
- (10) Each jack shall incorporate a dynamically irreversible screw thread adjustment as to length and shall have a foot of sufficient area and strength to ensure against settlement into ordinary dry soil surfaces.
- (11) A low arm or rail shall be provided at the off side of the driver's seat to prevent the driver sliding under the crane or losing control should it tilt or overturn laterally.
- (12) If the driver operates the crane from a position in which the driver might be injured by the jib, derrick or load, should either fall or rebound, an approved structure shall be provided for the driver's protection.

## **Gravity operated overwinding limit devices**

### **Electrical**

#### **136**

- (1) A gravity operated limit device consists of an electric switch opened by a weight attached directly or indirectly to a crank, drum, sheave or quadrant controlling the switch spindle.

**Part 11** Basic requirements about design and construction, erection, use, maintenance, inspection and testing with particular reference to cranes, lifts, hoists, scaffolding and plant

Section 136

---

- (2) A weight of greater predominance, attached in a somewhat similar way, holds the switch in the closed position until raised by some moving part of the mechanism that the limiting device is required to control.
- (3) As the predominant weight is raised, the opening weight takes effect.
- (4) The effective radius at which the switch opening weight acts shall be neither less than 4 inches nor more than 15 inches, measured from longitudinal axis of switch spindle, to centre of gravity of opening weight.
- (5) The torque developed by the opening weight shall not be less than 100 pounds-inches at the switch spindle at all times, irrespective of the position of the switch actuating quadrant, or crank, or opening weight.
- (6) When the switch is equipped with 'hammer' or 'impulse' weights to open, or assist in opening it, the abovementioned torque shall be increased by  $1\frac{1}{4}$  times the maximum torque required at the switch spindle to raise and trip the 'impulse weights'.
- (7) Approved resilient pads or stops shall be provided at both limits of travel of the opening weight to relieve the switch components of undue impact.
- (8) The switch actuating cord, as also all other cords employed, shall be galvanised flexible steel wire cord, not less than  $\frac{3}{4}$  of an inch in circumference and shall lead directly from the striking mechanism to the opening mechanism, without guides of any kind.
- (9) If the use of a diverting, or deflector, sheave is unavoidable, 1 only may be used to deflect the actuating cord in the desired direction, provided that—
  - (a) the sheave is not less than 4 inches in diameter at the bottom of the rope groove; or

- (b) the sheave has a symmetrical rope groove at least 1 inch deep, with sides enclosing a total angle of 60°; or
  - (c) the sheave is bored at least  $\frac{1}{64}$  of an inch larger in diameter than the pin on which it is to work and if practicable fitted with a self-lubricating bush; or
  - (d) the sheave shall not be fitted with any form of rope guard but shall work freely on a pin securely fastened in a rigid position on the adjacent structure, and sufficient clearances shall be allowed to ensure that the steel cord will not catch or jam in the event of it becoming frayed or displaced from the sheave; or
  - (e) free, or floating, sheave blocks attached to ropes shall not be used to deflect actuating cords.
- (10) All freely suspended weights shall have at least 1 additional approved safety cord, chain, or device, attached to them, to prevent the weight falling in the event of failure of its normal supports.
  - (11) Suspended weights shall not have guides, or be enclosed in casings.
  - (12) Suspended switch-closing, or 'striking' weights, above lifting hooks or other analogous media, shall be loosely connected to the hoisting ropes, or otherwise restrained, by approved means, to prevent undue relative displacement.
  - (13) Knife switches shall not be used.
  - (14) If the torque required at the switch spindle to open the switch, when in normally good condition and free of all actuating mechanisms, exceeds or may feasibly exceed 10 pounds-inches, additional opening torque of approved magnitude shall be provided.
  - (15) Layshafts or intermediate shafts shall not be used, but this shall not prevent extension of the switch spindle in an approved way.

## **Fork-lift trucks**

### **137**

- (1) A fork-lift truck means a short-wheelbase mobile truck or carriage having at the front end a rigid vertical steel frame or mast, usually telescopic, and commonly capable of being inclined from the vertical a few degrees fore or aft.
- (2) On or between the members of the mast a trolley moves in a vertical or near-vertical path, and carries projecting horizontal tines by means of which loads are raised and lowered.
- (3) Instead of tines, other lifting media such as a jib, pole, platform, scoop, or bucket may be used.
- (4) The basic safe working load for which a fork-lift truck is rated shall be determined as though the load were placed on the tines with its centre of gravity at a horizontal distance from the vertical faces of the tines equal to 1 inch plus  $\frac{1}{2}$  of the length of the longest pallet for which the tines are designed.
- (5) The vertical height of the centre of gravity of the load shall be assumed to be 30 inches above the tines.
- (6) Fork-lift trucks shall have approved robust overhead framings and grids to protect drivers against falling objects.
- (7) Grid apertures shall not be greater than 6 inches by 3 inches, but shall be sufficiently small to reject objects or articles of the least size handled by the truck, and must not, except if approved, reject anything less than a ball 1 inch in diameter.
- (8) To promote good vision, grid apertures shall be rectangular, and crimped meshings shall be used only if approved.
- (9) Guards shall be provided to prevent drivers' feet from being injured by moving members of the mast, or the trolley or lifting equipment.



- (10) An effective back guard shall be provided and fixed to the mast trolley to function as a back apron, and to prevent projecting loads from engaging the mast or lifting chains or mechanisms, or from becoming displaced.
- (11) The guards shall project at least 9 inches beyond each side of the mast structure.
- (12) Fork-lift trucks shall, when bearing loads, be used only on hard level surfaces.
- (13) If it is necessary for a fork-lift truck to negotiate a ramp or other incline, the mast end of the truck shall at all times be uphill.
- (14) While transporting loads, the tines or other analogous media shall not be raised above the level of the mast hinges.
- (15) While equipped with jibs, the masts shall be kept in the vertical position.
- (16) Reference should be made to section 127 (152) in regard to jibs.
- (17) Masts shall not be inclined forward, away from trucks, except when the tines are near floor level, or when the truck is close to the stack of goods or materials being handled.
- (18) Hooks of jibs of fork-lift trucks shall be so suspended that they can be freely displaced in any direction through an angle of at least 30° from the vertical.
- (19) Only approved load markings and notices shall be exhibited on fork-lift trucks.
- (20) The forward movement or inclination of the mast of a fork-lift truck shall not exceed 4° from the vertical.
- (21) The backward movement, towards the truck, shall not exceed 6° from the vertical.

## **Commercial type hoists**

### **138**

- (1) A commercial type hoist means a power-driven hoist winding or unwinding ropes, chains or other flexible media by which loads are raised or lowered from 1 floor or working surface to another.
- (2) The natural lateral oscillations of the loads are either entirely unconstrained or loosely constrained by flexible guides or by gravitationally induced pressure against skids.
- (3) Whether or not flexible guides or skids are employed, it is essential that the load be free to swing laterally and pass any 12 inch diameter obstruction that may enter its path.
- (4) In addition to other notices, brands or markings that may be prescribed elsewhere in this regulation, every such hoist shall be clearly, conspicuously and permanently branded with the name of its manufacturer, and with an appropriate and distinctive serial number.
- (5) All stations from which the hoist can be controlled shall be so placed or equipped that a driver at it can at all times clearly see the load.
- (6) If there is more than 1 control station, the controls at each station shall have a master control that must be actuated before the controls become operable.
- (7) On actuation of the master control at any station the controls of all other stations shall automatically become inoperable.
- (8) Landing flaps or rolling platforms shall not be used unless specifically approved.
- (9) The upper surfaces of landing flaps shall be inclined upwards towards their outer edges at an angle of not less than 15° to the horizontal.

- (10) Rolling platforms shall be securely fenced to prevent persons falling through floor openings or well holes, and shall be so devised that they do not at any time leave exposed openings.
- (11) Wherever practicable, means shall be provided by which persons may safely land or ship loads without having to closely approach the edges of floors or other working surfaces.
- (12) Well holes and floor openings shall be securely fenced and provided with toe boards not less than 4 inches in depth.
- (13) However, fencings and toe boards may be temporarily removed at 1 side only while loads are being landed or shipped, and that on completion of the operation, the fencings and boards shall be promptly replaced.
- (14) If well holes or floor openings have trapdoors, the doors shall be in pairs, and shall open upwards.
- (15) Each door shall in opening swing through an angle approximately 100° and shall constitute a fence or guard not less than 3 feet high for the opening otherwise exposed.
- (16) The ends of the opening shall, while the doors are open, be fenced as provided by subsections (12) and (13).
- (17) The edges of floors or working surfaces adjacent to which loads are raised or lowered shall be securely fenced.
- (18) However, fencings may be temporarily removed only while loads are being landed or shipped, and that on completion of the operation the fencings shall be promptly replaced.
- (19) If loads are to pass through openings, the least horizontal dimension of any of the openings shall be not less than the greatest horizontal length or diagonal or diameter of the load, or of the platform, box, yoke or vessel containing the load, whichever is the greater, plus 2 feet.

**Part 11** Basic requirements about design and construction, erection, use, maintenance, inspection and testing with particular reference to cranes, lifts, hoists, scaffolding and plant

Section 139

---

## **Tower hoists for constructional, building, demolition, or excavation works**

### **139**

- (1) A hoist tower means a vertical tower of rectangular section, within which loads are raised or lowered by means of a guided platform, guided bucket, or other convenient guided medium.
- (2) The tower is maintained in an upright position by guys or struts, or more commonly by being secured to an adjacent building or structure.
- (3) Each of the 4 sides, or faces, of the tower shall comprise a simple truss of plain orthodox design, capable of resisting transverse forces.
- (4) Neither the horizontal width nor the horizontal depth of a hoist tower shall exceed 6 feet, or be less than 5 feet.
- (5) All hoist towers shall be constructed of members not less in strength, rigidity and reliability than those prescribed by table 139, and no tower shall exceed the relevant and appropriate height prescribed, nor shall any panel of it be of any greater panel length.

**Table 139 Tower hoists for constructional, building, demolition or excavation works (for hoisting materials only), maximum heights and panel length and minimum dimensions of members**

maximum height of tower in feet		material	†max panel length	form of section of vertical	dimensions of section of vertical	form of section of horizontal bracings II	dimen-sions of section of horizontal bracings II	form of section of diagonal bracings II	dimen-sions of section of diagonal bracing II	form of section of top horizontal whalings #	dimen-sions of section of top horizontal whalings #	form of section of head-beams	dimen-sions of section of head-beams	form of section of tower base whalings	dimen-sions of section tower base whalings
guyed	supported‡														
200	200	pine timber *	60	rect-angular	one 4 × 4 or two 5 × 2	rect-angular	5 × 2	rect-angular	5 × 2	rect-angular	10 deep × 3 1/2 wide	rect-angular hard-wood	two 6 deep × 4 wide	rectangular	5 deep × 2 wide
200	200	mild steel	60	angle	3 × 3 × 5/16	angle	2 1/2 x 2 1/2 x 1/4	angle or 2 flats	2 1/2 x 2 1/2 x 1/4 Two 2 × 1/4	channel	7 deep × 3 wide	channel	6 deep × 3 wide	channel or angle	4 deep × 2 wide 3 × 3 × 5/16

**Part 11**

Basic requirements about design and construction, erection, use, maintenance, inspection and testing with particular reference to cranes, lifts, hoists, scaffolding and plant

Section 139

maximum height of tower in feet		material	†max panel length	form of section of vertical	dimensions of section of vertical	form of section of horizontal bracings II	dimen-sions of section of horizontal bracings II	form of section of diagonal bracings II	dimen-sions of section of diagonal bracing II	form of section of top horizontal whalings #	dimen-sions of section of top horizontal whalings #	form of section of head-beams	dimen-sions of section of head-beams	form of section of tower base whalings	dimen-sions of section tower base whalings
guyed	supported‡														
100 §	200	mild steel	60	round tube *	1.9 outside diameter × 0.192 wall thickness	round tube *	1.9 outside diameter × 0.192 wall thickness	round tube *	1.9 outside diameter × 0.192 wall thickness	ditto	ditto	ditto	ditto	round tube **	1.9 outside diameter × 0.192 wall thickness
120 §	200	aluminium alloy *	60	round tube *	1.9 outside diameter × 0.176 wall thickness	round tube *	1.9 outside diameter × 0.176 wall thickness	round tube *	1.9 outside diameter × 0.176 wall thickness	or to be framed in an approved way		ditto	ditto	round tube **	1.9 outside diameter × 0.176 wall thickness

- \* These must be of approved type and quality and material.
- † This may be measured as a vertical distance from centre to centre of the horizontal braces referred to in note II below.
- ‡ Provided tower is fully supported against wind and other lateral forces by being braced in an approved way to a building or structure equivalent to it.
- § This height may be increased by 30 feet if the major load or reaction applied by headbeams to tower is divided equally between 2 main verticals.
- II ie, internal bracings forming the web system of the tower, as distinct from the external bracings referred to in ‡ above.
- # ie, the particular whaling carrying greatest load from the headbeams, other whalings may be 6 in × 3 in pine timber. If practicable, however, the headbeams should be supported directly by the runners or by the corner posts or verticals of the tower, and in such case smaller whalings could be used.
- \*\* The vertical tubes shall in addition have approved feet or base plates.

Unless otherwise stated, all dimensions are in inches.

- (6) No person shall set up, or build, or set or place in position any hoist of greater size, or speed, or for bearing greater loads, or of different construction than prescribed in this section, until the person has submitted drawings of it to the chief inspector and obtained the chief inspector's approval.
- (7) The combined weight of the safe working load and the platform, bucket, or other medium by means of which it is raised or lowered shall not exceed 1 ton.
- (8) No person shall attach to or impose on any hoist tower, or any part of it, any load other than that borne by the platform, bucket, or medium analogous to it, and no person shall attach to any hoist tower or to any part of it any device capable of imposing such load, unless approved by the chief inspector.
- (9) However, subsection (8) shall not prevent the use of a dynamic counterbalance weight as prescribed in this section.

**Part 11** Basic requirements about design and construction, erection, use, maintenance, inspection and testing with particular reference to cranes, lifts, hoists, scaffolding and plant

Section 139

---

- (10) The speed at which any load is raised or lowered shall not exceed 600 feet per minute.
- (11) If dynamic (flying) counterbalance weights are employed, they shall not balance more than 70% of the unladen weight of the platform, bucket, or other medium by means of which loads are raised or lowered.
- (12) The corner posts or verticals of every hoist tower shall be braced together with horizontal braces and by it divided into panels each not greater in vertical height than 5 feet.
- (13) Every such panel shall contain 1 rigid, or alternatively 2 flexible braces, fixed diagonally to provide against shearing forces, and to complete the web system of the 4 trusses comprising the tower.
- (14) If, for purposes of access, it is necessary to omit any diagonal brace, the panel thus weakened shall be adequately strengthened by other bracing at least equivalent to that omitted.
- (15) No bolt less in diameter than  $\frac{5}{8}$  of an inch shall be used to connect or interconnect the members of a hoist tower, or to attach guides or runners to it.
- (16) Not less than 6 such bolts shall be effectively used in each splice made in the posts or verticals of every hoist tower, 3 being above, and 3 below the joint.
- (17) Each splice in the verticals of towers of metal or alloy tubes shall be designed for the full comprehensive load, and alternatively a tensile load of not less than 2 tons.
- (18) Every hoist tower shall be effectively supported laterally, at a level of not more than 30 feet above its base, and after that at levels not more than 30 feet apart, so that no greater length of tower than 30 feet remains unsupported.



- (19) In addition, the top of the tower shall be so supported if more than 20 feet above the next lower lateral supports, and in any case if carrying a hopper or tipping bucket or analogous device.
- (20) The lateral supports shall comprise at each such level not less than 4 flexible or extra flexible steel wire rope guys, each not less in circumference than 1<sup>1</sup>/<sub>2</sub> inches and each having an ultimate tensile value of not less than 5<sup>7</sup>/<sub>10</sub> tons.
- (21) Each guy rope shall have not less than 6 strands and each such strand shall have at least 19 wires.
- (22) All guys shall be effectively secured to the corner posts or verticals of the tower.
- (23) Alternatively, at the levels previously mentioned, the tower shall be effectively braced in an approved way to an adjacent building or other structure self-evidently capable of affording the tower complete support.
- (24) In plan view all guys shall appear as straight line continuations or extensions of the diagonals of a section of the tower.
- (25) A closely boarded platform of planks not less in thickness than 1<sup>1</sup>/<sub>2</sub> inches if pine timber and 1<sup>1</sup>/<sub>8</sub> inches if hardwood, shall be provided and fixed adjacent to the tower-head rope-sheaves as prescribed by section 127 (153) and (154).
- (26) The platform shall be protected on sides and ends by guardrails conforming with section 154.
- (27) If access to the platform cannot be safely obtained from the platform or bucket of the hoist, safe access ladders and platforms in accordance with section 154 shall be provided and fixed.

**Part 11** Basic requirements about design and construction, erection, use, maintenance, inspection and testing with particular reference to cranes, lifts, hoists, scaffolding and plant

Section 139

---

- (28) The hoist tower shall be effectively enclosed and shall be kept so enclosed, by close-fitting timber boarding not less than  $\frac{3}{4}$  of an inch in thickness or by 18-gauge wire netting having a mesh not greater than 2 inches, or by black or galvanised steel sheeting of thickness not less than 24 gauge, positively fixed to the outside of the tower frame to a height of not less than 6 feet above the level of every floor surface, scaffolding, platform or stairway adjacent to the hoist tower.
- (29) The verticals of hoist towers of metal shall not be subjected to transverse (bending) forces, and no rope deflector block or other device or attachment capable of applying such forces shall be fixed or applied to the verticals, or used.
- (30) Guardrails conforming with section 154 shall be provided and fixed across all openings giving access to the interior of all hoist towers.
- (31) The rails shall be so pivoted at at least 1 side of the opening that access is obtained by raising the rail or rails, which may be suitably counterbalanced.
- (32) Brackets or stops shall be provided which shall prevent guardrails being lowered below horizontal.
- (33) Guardrails shall be set 12 inches back from the tower face served by them.
- (34) No person shall raise or otherwise displace any guardrail unless the hoist platform is stationary and level with the floor or surface served by the rail, and all rails shall be replaced in the safe horizontal position before the platform moves from the floor or surface.
- (35) The horizontal clearance between the front or back edge of a hoist platform and the adjacent interior face of the tower bracings shall not exceed 2 inches.

- (36) An efficient and safe signalling arrangement shall be provided for the purpose of transmitting signals to the hoist driver as to when to raise and to lower the hoist platform or vessel, and also as to when to stop all motion of the hoist.
- (37) The signalling system shall be arranged so that its operation must be intentional on the part of the operator.
- (38) A warning bell, the sound of which will be distinctly and continuously heard when the platform is moving in any position of its travel, shall be fitted to every hoist platform.
- (39) No person other than a worker engaged in bona fide maintenance work shall ride on the hoist platform, bucket, or other medium by means of which loads are raised or lowered.
- (40) No person shall instruct, permit, or allow any other person so to do.
- (41) However, subsections (39) and (40) shall not apply for hoists designed and constructed in accordance with this regulation for raising or lowering workers.
- (42) A notice stating that persons are prohibited from riding on the platform or other lifting medium shall be fixed and kept so fixed in such a position on the hoist platform or medium that it can be clearly read by a person standing at least 3 feet away from the edge of the hoist platform, bucket, or other lifting medium.
- (43) However, subsection (42) shall not apply for hoists designed and constructed in accordance with this regulation for raising or lowering workers.
- (44) Every hoist winch shall have legibly painted, and kept so painted on it, a number for purposes of identification and record.
- (45) The safe working load shall be painted in positions where it will be clearly discerned by the hoist driver and by persons loading the hoist.

**Part 11** Basic requirements about design and construction, erection, use, maintenance, inspection and testing with particular reference to cranes, lifts, hoists, scaffolding and plant

Section 140

---

- (46) All openings in floors, walls, or other parts of the building or structure through which a hoist operates shall be fenced with guardrails conforming with section 154.
- (47) The rails shall be set 12 inches back from the adjacent edges of the openings.
- (48) All winch control levers, and the controls of the engine or electric motor driving the winch, shall be so grouped that every such control lever and control is within workable reach of the person acting as driver in charge of the hoist from the position that the person takes up when driving the hoist.
- (49) The maximum throw of the control lever of a friction hoist winch shall not exceed 60°.

**Whip or sheerleg hoists for constructional, building, demolition, or excavation works**

**140**

- (1) A whip hoist means a simple sheerlegs or other approved frame, set at the brink of an elevated platform or surface, or of a hole, and carrying rope and sheave equipment by means of which loads are raised or lowered.
- (2) The loads commonly consisting of barrows of building material, and being steadied and guided to some extent by being allowed to slide or drag against skidboards or equivalent devices during ascent and descent.
- (3) Each leg of the sheerlegs shall, if of pine timber, be not less in section than 5 inches by 3 inches.
- (4) It shall be of sufficient length to extend at least 12 inches above the top connecting bolt.

- (5) The horizontal distance between the lower ends of the legs of the sheerlegs shall not be greater than 7 feet 6 inches, and the vertical height of the top connecting bolt of the sheerlegs shall not be less than 14 feet above the level at which that horizontal distance is measured.
- (6) Alternatively or if a large sheerlegs is required, the angle contained between either leg and the horizontal shall not be less than 75°.
- (7) Sheerlegs shall be symmetrical in construction.
- (8) The top connecting bolt mentioned in subsection (4) shall not be less in diameter than  $\frac{3}{4}$  of an inch and the nut shall be locked.
- (9) The legs of the sheerlegs shall rest on a base plank not less in section than 12 inches in horizontal width by 2 inches thick.
- (10) The legs shall be prevented from spreading, and from moving towards the edges of the base plank by hardwood battens 3 inches by 2 inches in section, bolted to the base plank by bolts not less in diameter than  $\frac{1}{2}$  inch.
- (11) In addition the legs shall be prevented from lifting over the battens by wire rope lashings passing through holes drilled not less than 6 inches above the lower ends of the legs.
- (12) The topmost hoisting block shall be suspended on a  $1\frac{1}{2}$  inch circumference steel wire rope snorter having not less than 6 strands each containing not less than 24 wires, and the snorter shall lie or rest in the topmost V formed between the legs, above the top connecting bolt.
- (13) The back guy shall be of steel wire rope at least  $1\frac{3}{8}$  inches in circumference, having not less than 6 strands each containing not less than 19 wires.
- (14) It shall be secured to the sheerlegs at their intersection, by at least 2 full turns and 2 approved wire-rope grips.

**Part 11** Basic requirements about design and construction, erection, use, maintenance, inspection and testing with particular reference to cranes, lifts, hoists, scaffolding and plant

Section 140

---

- (15) Alternatively, this fastening may comprise 2 full turns and a spliced eye.
- (16) The front, or lazy guy, shall be of rope of the same construction as the back guy, not less in circumference than  $1\frac{1}{8}$  inches, fastened as previously mentioned.
- (17) Alternatively, the front guy may be of approved fibre rope not less in circumference than  $2\frac{1}{2}$  inches.
- (18) The guys shall be so adjusted that the total fore and aft movement of the topmost bolt of the sheerlegs shall not exceed 30 inches in any circumstances.
- (19) Smooth skids not less in horizontal width than 45 inches shall be provided and fixed in such a way that they guide the barrow or other lifting medium and its load smoothly from level to level.
- (20) Landings for barrows, or loads, shall be not less than 9 feet in width by 14 feet in length, and shall be provided with handrails at the idle sides.
- (21) The hauling rope shall lead or pass from the top block in a direction as nearly as practicably parallel to 1 of the legs of the sheerlegs, and then through a guide or deflector block secured to the foot of the leg, or to a point closely adjacent to it, before passing to the winch.
- (22) Guardrails shall be provided and so fixed, that persons not actively engaged in the hoisting operations are restrained from entering within 15 feet of the skids, and no person unless so engaged shall so enter.

## Part 12 Plant and gear

### General

#### 141

- (1) All plant and gear and every part of it shall be of sound material, good construction, adequate strength, free from patent defects and be suitable and safe for the purpose for which it is intended.
- (2) If in this part reference is made to any of the rules, codes or specifications of Standards Australia or the British Standards Institution, each shall be interpreted as intended by the rules, codes or specifications.
- (3) Unless elsewhere more specifically prescribed by this regulation all hooks, rings, egg links, intermediate links, shackles, Bordeaux connections, rope clips, rope sockets, eyebolts, rigging screws, turnbuckles, swivels, and analogous media that conform in all respects with the requirements of a standard specification promulgated by Standards Australia shall be deemed to be within classification 3 of section 122.
- (4) If the media are to be used in connection with any crane, lift, hoist, scaffolding or plant within classification 4 of section 122, they shall be further increased in strength by not less than 18<sup>1/2</sup>% .

### Ladders

#### Definitions

#### 142

- (1) In this section:

***ladder*** means an appliance usually consisting of 2 side rails or stiles joined at regular intervals by cross pieces called steps, rungs or treads, on which a person may rest or step in ascending or descending.

**single ladder** means a non-self-supporting portable ladder, non-adjustable in length consisting of but 1 section and its size is designated by the overall length of a side rail.

**extension ladder** means a non-self-supporting portable ladder adjustable in length, consisting of 2 or more sections being in guides or brackets so arranged to permit length adjustment and its size being designated by the maximum extended working length of the ladder measured along the side rails.

**stepladder** means a self-supporting portable ladder, non-adjustable in length, having flat steps or treads and hinged back legs and its size being designated by the overall length of the ladder measured along the front edge of the side rails.

**trestle ladder** means a self-supporting portable ladder consisting of 2 sections hinged at the top to form equal angles with the base and its size is designated by the length of the side rails measured along the front edge.

**fixed ladder** means a ladder that is permanently attached to a building or structure.

### General

- (2) Timber used in a ladder shall not be painted.
- (3) If a timber preservative is used it shall be and remain transparent on the timber.
- (4) Ladders shall be kept clean and free from dirt, moisture or splashing of paint or materials.
- (5) Ladders with broken, split, or otherwise defective or loose components shall not be used, or kept or placed where they may be used.
- (6) All timber shall be dressed on all sides and shall have all corners rounded and free from splinters or slivers.



- (7) Where nails or screws are required in a connection, at least 2 shall be used unless otherwise prescribed in this section.
- (8) Unless otherwise approved all materials shall comply with this regulation.
- (9) Every ladder and every part of it shall be of sound material, good construction, adequate strength, free from patent defects, and be suitable and safe for the purpose for which it is intended.

#### *Materials*

- (10) All timber used in the construction of ladders shall be of Oregon or other approved timber.
- (11) All timber shall comply with the provisions of 'select grade for scantlings' provided in the Australian Standard Grading Rules (Emergency Series) for Sawn and Hewn Structural Timbers, No (E) O.54-1942, promulgated by Standards Australia, as amended in June, 1944.
- (12) In addition, the slope of the grain shall not exceed 1 inch in 20 inches and no defect shall occur except in the middle 3rd of the timber cross-section.
- (13) Brash (Carrotty) timber shall not be used.
- (14) Low density timber of weight less than 30 pounds per cubic foot shall not be used.

#### *Single ladders—ladders not to exceed 30 feet in length*

- (15) Single ladders exceeding 30 feet in length shall not be used unless otherwise approved.

#### *Single ladders—side rails (stiles)—dimensions*

- (16) The dimensions of side rails shall be not less than those provided in table 142.1:

**Table 142.1 Dimensions of timber single ladders**

<b>ladder length (in feet)</b>	<b>side rails (stiles) least dimensions (in inches)</b>
14 and under	$2\frac{1}{2} \times 1\frac{3}{8}$
15 to 22	$3\frac{1}{4} \times 1\frac{3}{8}$
22 to 30	$3\frac{3}{4} \times 1\frac{3}{4}$

*Single ladders—side rails (stiles)—drilling for rungs*

- (17) All holes for rungs shall be accurately bored through the centre-line of the wide face of each side rail.
- (18) If practicable rungs shall not fit through the full thickness of side rail.
- (19) The holes for rungs shall be  $\frac{1}{16}$  of an inch deeper than the rung tenon but there shall be at least  $\frac{1}{4}$  of an inch of solid timber between the bottom of the hole and the outside face of the side rail.

*Single ladders—side rails (stiles)—spacing between side rails*

- (20) The width between inside faces of side rails shall be not less than  $10\frac{1}{2}$  inches and shall not be more than 14 inches, unless otherwise approved.

*Single ladders—side rails (stiles)—spacing of rungs*

- (21) All rungs shall be equally spaced.
- (22) The spacing shall be not less than  $8\frac{1}{2}$  inches or more than  $10\frac{1}{2}$  inches measured centre to centre unless otherwise approved.
- (23) The distance from the bottom of the side rails to the centre of the nearest rung shall be the same as the spacing of the rungs.

*Single ladders—rungs—material*

- (24) All rungs shall be of spotted gum or other timber of at least equivalent strength and suitability.
- (25) All timber so used shall be well-seasoned, straight-grained, free from sap wood, knots and other defects.

*Single ladders—rungs—dimensions*

- (26) Rungs shall be  $1\frac{1}{8}$  inches diameter reduced at each end to form tenons  $\frac{7}{8}$  of an inch diameter.
- (27) Rungs shall extend at least  $\frac{3}{4}$  of an inch into side rails and if practicable shall finish  $\frac{5}{16}$  of an inch from the outer face of side rails.

*Single ladders—rungs—attachment of rungs to side rails*

- (28) Rung tenons shall be a tight fit in the side rails and the shoulders shall fit accurately against the side rails.
- (29) Each rung tenon shall be prevented from turning by means of a nail at least 0.104 inches diameter (12 gauge), driven through the narrow edge of the side rail and passing completely through the rung tenon.

*Single ladders—ties—side rail to side rail—material*

- (30) Ties shall be of steel or other approved material.

*Single ladders—ties—side rail to side rail—dimensions*

- (31) Ties of steel shall be not less than  $\frac{1}{4}$  or more than  $\frac{3}{8}$  of an inch diameter and shall be fitted with washers at each end made of at least 0.05 inches thickness (18 gauge steel), twice the diameter of the tie rod hole in each side rail.

*Single ladders—ties—side rail to side rail—spacing of ties*

- (32) A tie shall be fitted at the top and bottom rungs.

- (33) Intermediate ties shall be fitted to at least every 6th rung.
- (34) Ties shall be equally spaced if practicable and shall be fitted immediately below their adjacent rungs, pass through the centre-line of the wide face of each side rail and be well rivetted over washers at their ends to prevent spreading of the side rails.

*Extension ladders—extension ladders not to exceed 50 feet in length*

- (35) An extension ladder exceeding 50 feet in length shall not be used unless otherwise approved.

*Extension ladders—side rails (stiles)—dimensions*

- (36) Side rails shall have dimensions not less than those provided in table 142.2.

*Note* Table 142.2 is after s (66).

*Extension ladders—side rails (stiles)—drilling for rungs*

- (37) All holes for rungs shall be accurately bored through the centre-line of the wide face of side rails.
- (38) If practicable rungs shall not fit through the full thickness of side rail.
- (39) The holes for rungs shall be  $\frac{1}{16}$  of an inch deeper than the rung tenon but there shall be at least  $\frac{1}{4}$  of an inch of solid timber between the bottom of the hole and the outside face of the side rail.

*Extension ladders—side rails (stiles)—spacing of rungs*

- (40) All rungs shall be equally spaced.
- (41) The spacing shall be 12 inches measured centre to centre.

*Extension ladders—side rails (stiles)—spacing between side rails*

- (42) The width between inside faces of side rails shall be not less than  $10\frac{1}{2}$  inches and not more than 15 inches.

*Extension ladders—side rails (stiles)—reinforcing of side rails*

- (43) The tension edge of each side rail shall be grooved and fitted with galvanised steel reinforcing wire or its approved equivalent.
- (44) Wire of size not less than 0.128 inches diameter (10 gauge) shall be used for extension ladders of 32 feet or under and wire of size of not less than 0.16 inches diameter (8 gauge) shall be used for extension ladders over 32 feet in length.
- (45) This wire shall be so fitted that when the ladder is straight the wire is sufficiently tensioned to keep it taut at the bottom of the groove.
- (46) The wire shall be stapled in the groove and anchored at each end in an approved way.

*Extension ladders—side rails (stiles)—overlap of side rails when fully extended*

- (47) The overlap of each side rail in the fully extended position shall be not less than that in table 142.2.

*Note* Table 142.2 is after s (66).

*Extension ladders—rungs—material*

- (48) All rungs shall be made of spotted gum or other approved timber of equivalent characteristics and suitability.
- (49) The timber so used shall be well-seasoned, straight-grained, free from sapwood, knots and other defects.

*Extension ladders—rungs—dimensions*

- (50) Rungs shall be  $1\frac{1}{8}$  inches diameter reduced at each end to form tenons  $\frac{7}{8}$  of an inch diameter.
- (51) Rungs shall extend at least  $\frac{3}{4}$  of an inch into side rails and if practicable shall finish  $\frac{5}{16}$  of an inch from the outer face of side rail.

*Extension ladders—rungs—attachment of rungs to side rails*

- (52) Rung tenons shall be a tight fit in the side rail and the shoulders shall fit accurately against the same.
- (53) Each rung tenon shall be prevented from turning by means of a nail at least 0.092 inches diameter (13 gauge) driven through the narrow edge of the side rail and passing completely through the rung tenon.

*Extension ladders—safety lock fittings and side rail guides*

- (54) Every extension ladder shall be fitted with an approved lock and guide brackets that shall effectively allow the ladder to be extended, retracted and locked in any position.
- (55) The lock shall be reliable in principle, simple in detail and capable of safe operation in any extended position of the ladder.
- (56) It shall be so arranged that it will maintain the sections of the ladder in the relative position to each other that the rungs of the sections overlapping in every stage of extension shall form double treads.

*Extension ladders—extension ropes and pulleys*

- (57) All extension ladders longer than 14 feet when fully extended shall be provided with extension ropes that shall be fibre rope of approved quality not less than 1 inch circumference.
- (58) Extension ladders longer than 34 feet when fully extended shall be fitted with 2 fibre ropes.
- (59) The ropes shall be effectively anchored and maintained.
- (60) Pulleys shall be fitted to properly accommodate the extension ropes, and shall have axles not less than  $\frac{1}{4}$  of an inch in diameter.
- (61) The pulleys shall be fitted to either side(s) or centre of ladder.

*Ties—side rail to side rail—material*

- (62) Ties shall be of steel or other approved material.

*Ties—side rail to side rail—dimensions*

- (63) Ties, if of steel, shall be  $\frac{1}{4}$  of an inch diameter and shall be fitted with washers at each end at least 0.05 inches thickness (18 gauge steel), twice the diameter of the tie rod hole in each side rail.

*Ties—side rail to side rail—spacing of ties*

- (64) A tie shall be fitted at the top and bottom rungs if practicable.
- (65) Intermediate ties shall be fitted to at least every 6th rung.
- (66) Ties shall be equally spaced if practicable and shall be fitted immediately below their adjacent rungs, pass through the centre-line of the wide face of each side rail and be well rivetted over washers at their ends to prevent spreading of the side rails.

**Table 142.2 Dimensions of timber extension ladders**

ladder length fully extended (in feet)	minimum overlap of side rails (in feet)	side rails (stiles) least dimensions (in inches)
26 and under	2	2 $\frac{1}{4}$ x 1 $\frac{1}{4}$
28 to 30	2	2 $\frac{1}{2}$ x 1 $\frac{3}{8}$
32 to 34	4	2 $\frac{1}{2}$ x 1 $\frac{3}{8}$
36 to 46	4	2 $\frac{3}{4}$ x 1 $\frac{3}{4}$
48 to 50	6	3 $\frac{1}{4}$ x 1 $\frac{3}{4}$

*Stepladders not to exceed 18 feet in length*

- (67) A stepladder exceeding 18 feet in length shall not be used unless otherwise approved.

*Side rails (stiles) and back legs—dimensions*

- (68) Side rails and back legs shall have dimensions not less than those provided in table 142.3.

*Note* Table 142.3 is after s (117).

*Side rails (stiles) and back legs—spacing and spread between side rails*

- (69) The width between inside faces of side rails measured at the top tread shall be not less than 11<sup>1</sup>/<sub>2</sub> inches, and shall be not more than 13 inches.
- (70) This distance shall increase towards the lower treads at a rate of not less than 1<sup>1</sup>/<sub>2</sub> inches and not more than 1<sup>3</sup>/<sub>4</sub> inches per foot length of side rail.

*Side rails (stiles) and back legs—spacing and spread between back legs*

- (71) Spacing and spread between back legs shall be the same as for side rails.

*Side rails (stiles) and back legs—spread between side rails and back legs*

- (72) In the fully-opened position, the spread between side rails and back legs shall be not less than 8 inches or more than 9 inches per foot length of side rails.

*Stepladders—restraining rope*

- (73) The spread between side rails and back legs shall be restrained by means of first quality fibre rope not less than <sup>3</sup>/<sub>4</sub> of an inch in circumference fitted between each back leg and its respective side rail.
- (74) These ropes shall be effectively anchored at 1 end through the centre of the wide face of each side rail immediately below the tread 2nd from the bottom, and at the other end through the centre of the wide face of each back leg at the same level.



- (75) Alternatively, other approved means of restraining the side rails and back legs may be used.

*Stepladders—bracing for back legs—battens*

- (76) Back legs shall be battened together with battens of timber or other approved material.
- (77) If of timber, they shall have dimensions not less than those provided in the table after subsection (117).
- (78) Back legs shall be battened together at the hinge and also at the level of the 2nd tread from the bottom.
- (79) Stepladders over 8 feet in length shall have extra battens fitted and equally spaced.
- (80) In no case shall the distance between adjacent battens exceed 6 feet.
- (81) Battens shall be screwed, nailed or bolted.

*Stepladders—bracing for back legs—diagonal bracing*

- (82) Doubled diagonal bracing of timber or other approved material shall be screwed, nailed, or bolted to the back legs between and against adjacent battens.
- (83) The bracing, if of timber or mild steel, shall have dimensions not less than those provided in table 142.3.

*Note* Table 142.3 is after s (117).

*Stepladder—treads—material*

- (84) Treads shall be constructed of timber.

*Stepladders—treads—dimensions*

- (85) Treads shall have dimensions not less than those provided in table 142.3.

*Note* Table 142.3 is after s (117).

*Stepladders—treads—spacing*

- (86) Treads shall be equally spaced from the bottom of side rails to the top of top step.
- (87) The spacing shall be not less than 10 inches or more than 12 inches top to top of treads.
- (88) Treads shall be parallel and level when the stepladder is in position for use.

*Stepladders—treads— attachment of treads to side rails*

- (89) Treads shall be recessed into the side rails or secured to them in an approved way.
- (90) If the treads are recessed into the side rails, the recesses in the rails for the treads shall be not more than  $\frac{1}{4}$  of an inch deep or less than  $\frac{3}{16}$  of an inch deep and shall properly accommodate their treads.
- (91) Treads so fitted shall be double screwed to the side rails at each end using wood screws of 0.189 inches diameter (10 gauge) not less than  $1\frac{1}{2}$  inches or more than  $1\frac{3}{4}$  inches long.
- (92) The screws shall be screwed into the centre-line of the tread at each end.

*Stepladders—bracing for treads—material*

- (93) Bracing for treads shall be of timber or other approved material and shall be screwed or nailed in position.

*Stepladders—bracing for treads—dimensions*

- (94) Bracing for treads shall have dimensions not less than those provided in table 142.3.

*Note* Table 142.3 is after s (117).

*Stepladders—bracing for treads—attachment of bracing to treads*

- (95) The backs of treads shall be braced each side adjacent to the side rails with a bracing strip fitted in a direction parallel with the side rails.
- (96) The bracing strips shall be so fitted that distance between them measured along a tread shall be not less than 10<sup>1</sup>/<sub>2</sub> inches.
- (97) The distance between the outside face of a side rail and the inner edge of adjacent bracing strip shall not exceed 4 inches.

*Stepladders—top step—material*

- (98) The top step at the extreme top of the stepladder shall be constructed of timber.

*Stepladders—top step—dimensions*

- (99) The top step shall be not less than 15 inches long, 4<sup>1</sup>/<sub>2</sub> inches wide, and <sup>13</sup>/<sub>16</sub> of an inch thick, or more than 16 inches long, 5 inches wide and 1 inch thick.

*Stepladders—back support plate for top step—material*

- (100) The back support plate shall be of timber or other approved material.

*Stepladders—back support plate for top step—dimensions and fitting*

- (101) The back support plate, if of timber, shall be not less than 15 inches long, 3<sup>1</sup>/<sub>2</sub> inches wide and <sup>13</sup>/<sub>16</sub> of an inch thick.
- (102) This plate shall properly accommodate the strap hinges if they are used and shall with the side rails properly support the top step.

*Stepladders—hinges*

- (103) Stepladders whose length is 8 feet or less shall have the back legs hinged by means of 2 (two) 6 inch steel strap hinges or other approved method.

- (104) The strap hinges shall be of not less than 0.062 inches thickness (16 gauge steel) and shall be secured by bolts or wood screws, both bolts or screws to be not less than 0.149 inches diameter (7 gauge) <sup>3</sup>/<sub>4</sub> of an inch long.
- (105) Cast hinges shall not be used.
- (106) Stepladders whose length exceeds 8 feet shall have their back legs hinged direct to the side rails.
- (107) For this purpose, the back legs shall be so arranged that they lie on the outside of their respective side rails, wide face to wide face.
- (108) The hinge shall consist of 2 bolts not less than <sup>3</sup>/<sub>8</sub> of an inch or more than <sup>1</sup>/<sub>2</sub> an inch in diameter, each bolt connecting a back leg and its adjacent side rail each side.
- (109) Each hinge bolt shall pass through the centre-line of the wide faces of adjacent members, shall be in line and be fitted not less than 3 inches from the ends of side rails and back legs and nuts shall be properly riveted over.
- (110) Metal bearing plates of at least 0.05 inches (18 gauge) thickness shall be fitted to each face of each back leg and side rail on which the hinge bolts shall bear.
- (111) A clearance hole <sup>1</sup>/<sub>16</sub> of an inch greater in diameter than the hinge bolt shall be drilled in the side rails and back legs for this purpose.

*Stepladders—ties—side rails to side rails—material*

- (112) Ties shall be of steel or other approved material.

*Stepladders—ties—side rails to side rails—dimensions*

- (113) Ties, if of steel, shall be not less than <sup>1</sup>/<sub>4</sub> or more than <sup>3</sup>/<sub>8</sub> of an inch in diameter and be fitted with washers at each end at least 0.05 inches thickness (18 gauge steel) twice the diameter of the tie rod hole in each side rail.

*Stepladders—ties—side rails to side rails—spacing and attachment of ties*

- (114) Ties shall be fitted to all stepladders whose lengths exceed 5 feet.
- (115) Ladders over 5 feet in length shall have at least 2 ties.
- (116) One tie shall be fitted at the bottom tread, ties shall be equally spaced if practicable, and the maximum distance between ties or tie and top step shall not exceed 5 feet.
- (117) Ties shall be fitted immediately below their adjacent treads, pass through the centre-line of the wide face of each side rail and be well riveted over washers at their ends to prevent spreading of the side rails.

**Table 142.3 Dimensions of timber stepladders**

ladder length (in feet)	least dimensions of components (in inches)						
	side rails (stiles)	back legs	treads	battens for back legs	diagonal bracing for back legs		bracing for treads
					timber	mild steel	
8 and under	3 × 1	2 <sup>3</sup> / <sub>4</sub> × 3/ <sub>4</sub>	3 <sup>1</sup> / <sub>2</sub> × 13/ <sub>16</sub>	2 <sup>3</sup> / <sub>4</sub> × 3/ <sub>4</sub>	1 <sup>3</sup> / <sub>4</sub> × 5/ <sub>16</sub>	3/ <sub>4</sub> × 1/ <sub>8</sub>	1 <sup>3</sup> / <sub>4</sub> × 5/ <sub>16</sub>
9 to 12	3 <sup>1</sup> / <sub>4</sub> × 1	3 × 1	3 <sup>1</sup> / <sub>2</sub> × 13/ <sub>16</sub>	2 <sup>3</sup> / <sub>4</sub> × 3/ <sub>4</sub>	1 <sup>3</sup> / <sub>4</sub> × 5/ <sub>16</sub>	3/ <sub>4</sub> × 1/ <sub>8</sub>	1 <sup>3</sup> / <sub>4</sub> × 5/ <sub>16</sub>
13 to 18	3 <sup>3</sup> / <sub>4</sub> × 1	3 <sup>1</sup> / <sub>4</sub> × 1	3 × 1	2 <sup>3</sup> / <sub>4</sub> × 3/ <sub>4</sub>	1 <sup>3</sup> / <sub>4</sub> × 5/ <sub>16</sub>	3/ <sub>4</sub> × 1/ <sub>8</sub>	1 <sup>3</sup> / <sub>4</sub> × 5/ <sub>16</sub>

*Trestle ladders—trestle ladders not to exceed 16 feet in length*

- (118) A trestle ladder exceeding 16 feet in length shall not be used unless otherwise approved.

*Trestle ladders—side rails (stiles)—dimensions*

- (119) Side rails shall have dimensions not less than those provided in table 142.4.

*Note* Table 142.4 is after s (150).

*Trestle ladders—side rails (stiles)—spacing and spread between adjacent side rails*

- (120) The width between inside faces of side rails measured at the top rung shall be not less than 15 inches or more than 21 inches for trestle ladders up to and including 8 feet in length, and not less than 19 inches or more than 21 inches for trestle ladders over 8 feet in length.
- (121) This dimension shall increase towards the lower rungs at the rate of not less than 1<sup>1</sup>/<sub>2</sub> inches and not more than 1<sup>3</sup>/<sub>4</sub> inches per foot length of side rails.

*Trestle ladders—side rails (stiles)—spread between the pairs of side rails in the fully opened position*

- (122) In the fully opened position the spread between the pairs of side rails shall be not less than 4 inches or more than 8 inches per foot length of side rails.

*Trestle ladders—side rails (stiles)—holes in side rails for rungs*

- (123) All holes for rungs shall be accurately machined so that all rungs pass through the centre-line of the wide faces of the side rail.
- (124) If practicable rungs shall not fit through the full thickness of side rails.
- (125) The holes for rungs shall be <sup>1</sup>/<sub>16</sub> of an inch deeper than the rung tenon, but there shall be at least <sup>1</sup>/<sub>4</sub> of an inch of solid timber between the bottom of the hole and the outside face of the side rail.

*Trestle ladders—side rails (stiles)—spacing of rungs*

- (126) All rungs shall be equally spaced.
- (127) The spacing shall be not less than 20 inches or more than 24 inches centre to centre.

- (128) Rungs spacing in pairs of side rails shall be staggered so that when the trestle ladder is in the closed position the rungs will present an equal spacing of  $\frac{1}{2}$  that on either pair of side rails.
- (129) The top rung on either pair of side rails shall not be closer to the top than 6 inches.

*Trestle ladders—restraining rope*

- (130) The spread between the pairs of side rails shall be restrained by means of first quality fibre rope not less than  $\frac{3}{4}$  of an inch in circumference.
- (131) These ropes shall be effectively anchored at 1 end through the centre of the wide face of each side rail at the same level and at about the 2nd rung from the bottom.
- (132) Alternatively, other approved means of restraining the side rails may be used.

*Trestle ladders—rungs—dimensions*

- (133) Rungs shall have dimensions not less than those set out in table 142.4.  
*Note* Table 142.4 is after s (150).
- (134) In addition, the cross-section shall be reduced at each end to form a shoulder for tenons, whose cross-section shall be not less than  $\frac{3}{4}$  of an inch wide and  $1\frac{1}{2}$  inches deep, and not more than  $\frac{7}{8}$  of an inch wide and the depth of the rung.
- (135) Tenons shall be not less than 1 inch long and if practicable shall finish at least  $\frac{5}{16}$  of an inch from the outer face of side rails.

*Trestle ladders—rungs—attachment of rungs to side rails*

- (136) Rung tenons shall be a tight fit in the side rail and the shoulders shall fit accurately against them.

- (137) Each tenon shall be secured by means of 2 nails at least 0.104 inches diameter (12 gauge) driven through the narrow edge of the side rail passing completely through the tenon.

*Trestle ladders—hinges*

- (138) Trestle ladders shall have their pairs of side rails hinged together at the top by means of hinges constructed of steel not less than 1<sup>1</sup>/<sub>4</sub> inches wide and not less than <sup>1</sup>/<sub>4</sub> of an inch thick.
- (139) The securing bolts shall be <sup>5</sup>/<sub>16</sub> of an inch diameter.
- (140) The hinge pins shall be of steel not less than <sup>5</sup>/<sub>16</sub> of an inch in diameter and shall be in line.
- (141) Alternatively, other approved means of hinging may be used.
- (142) Cast hinges shall not be used.

*Trestle ladders—hinges—trestles 12 feet or less*

- (143) Trestle ladders 12 feet or less in length shall have hinges not less than 10 inches long each side of the hinge pin, and each side secured to side rails with 2 bolts.

*Trestle ladders—hinges—trestle ladders more than 12 feet*

- (144) Trestle ladders more than 12 feet in length shall have hinges not less than 14 inches long each side of hinge pin, and each side secured to side rails with 3 bolts.

*Trestle ladders—ties—side rail to side rail—material*

- (145) Ties shall be of steel or other approved material.

*Trestle ladders—ties—side rail to side rail—dimensions*

- (146) Ties if of steel shall be not less than <sup>3</sup>/<sub>8</sub> of an inch or more than <sup>7</sup>/<sub>16</sub> of an inch diameter and be fitted with washers of at least 0.062 inches



thickness (16 gauge steel) twice the diameter of the tie rod hole in the side rail, and 1 end of each tie rod shall be screwed and fitted with a standard nut.

*Trestle ladders—ties—side rail to side rail—spacing and attachment of ties*

- (147) Ties shall be fitted to both pairs of side rails in all trestle ladders.
- (148) One tie shall be fitted at the bottom rung and 1 at the top rung.
- (149) The distance between ties shall not exceed 4 feet.
- (150) Ties shall be fitted immediately below their adjacent rungs, pass through the centre-line of the wide face of each side rail, and be well riveted over at their ends to prevent spreading of side rails.

**Table 142.4 Dimensions of timber trestle ladders**

ladder length (in feet)	least dimensions (in inches)	
	side rails (stiles)	rungs
14 and under	2 <sup>1</sup> / <sub>2</sub> x 1 <sup>3</sup> / <sub>8</sub>	2 <sup>1</sup> / <sub>2</sub> x 1 <sup>3</sup> / <sub>8</sub>
14 to 16	2 <sup>3</sup> / <sub>4</sub> x 1 <sup>3</sup> / <sub>4</sub>	2 <sup>3</sup> / <sub>4</sub> x 1 <sup>3</sup> / <sub>4</sub>

*Trestle ladders—handrails*

- (151) Provision shall be made in the construction of all trestle ladders exceeding 10 feet in length for the attachment of approved uprights and handrails.

*Fixed Ladders*

- (152) Fixed ladders shall, unless indoor, be of steel.
- (153) If of timber, the ladders shall conform with this section.
- (154) If of steel, ladders shall have stiles not less in section than 2 inches deep by <sup>1</sup>/<sub>4</sub> of an inch in thickness.

- (155) The rungs of steel fixed ladders shall be not less than  $\frac{3}{4}$  of an inch in diameter and shall not be spaced further apart than 10 inches, measured centre to centre.
- (156) They shall be strongly fixed and prevented from rotating.
- (157) Stiles of steel fixed ladders shall be not less than 15 inches apart.
- (158) Ladders shall be set at an angle approximating  $15^\circ$  from the vertical.
- (159) A ladder shall not lean over a person climbing.
- (160) The clearance at the back of the rungs shall not be less than 6 inches, and no obstruction shall be within 30 inches of the face of the ladder.
- (161) There shall be not less than 3 inches clearance between the outside of each stile and the nearest permanent object at the side.
- (162) Ladders shall conform with section 127 (156) and (159) to (161).
- (163) No ladder shall be of greater length than 20 feet.
- (164) Rest platforms shall be provided at the upper ends of each length, and the platforms shall be not less than 18 inches in width by 22 inches in length, and shall have handrails at outer ends and both sides.
- (165) If it is necessary for a ladder to pass closely through a hole in a platform or floor surface, the edge of the hole that is parallel to the ladder rungs shall be padded on the underside with rubber or other resilient material to prevent injury to persons ascending.
- (166) Ladders, or the stiles of the ladders, shall continue for a distance of at least 45 inches above the upper surface of the platform or landing served.
- (167) They shall have adequate lateral support.
- (168) If practicable the rungs of ladders shall, in plan view appear to be at an angle of  $90^\circ$  to the adjacent edge of the platform or surface served.
- (169) Ladders shall be strongly bolted or welded in position.

- (170) All ladders from which a person or object might otherwise fall a distance of 20 or more feet shall be enclosed in an approved way with heavy gauge steel meshing.
- (171) The approximately vertical sides of the mesh opening shall not exceed 5 inches in depth.

### **Chain for use in connection with cranes, lifts, hoists, scaffolding, plant, gear, or building work, excavation work, or compressed air work**

#### **143**

##### *Definitions*

- (1) In this section:

**material**—unless otherwise stated all chain referred to in this section shall be of mild steel or wrought iron, and the **material** shall conform with the requirements of the relevant specification referred to in subsections (15) to (19).

**size of chain** means the diameter of the material of which the chain is made, measured after the chain has been fabricated.

**normalising** means heat treatment carried out in a furnace so designed that the chain is heated through and brought up to the normalising temperature of 1 650° Fahrenheit, uniformly throughout its mass, the conditions of heating being such that a reducing atmosphere is maintained, and the chain afterwards being removed from the furnace and allowed to cool freely in still air.

**annealing** means heat treatment carried out in a furnace so designed that the chain is heated through and brought up to the annealing temperature of 1 110° to 1 200° Fahrenheit, uniformly throughout its mass, the conditions of heating being that a reducing atmosphere is maintained, and the chain afterwards being removed from the furnace and allowed to cool freely in still air.

*General*

- (2) Chain with bent or otherwise deformed links shall not be used.
- (3) Knotted chains shall not be used.
- (4) Suitable packing shall be provided and used to prevent chain links coming into contact with sharp edges of loads of hard material.
- (5) Chains shall not be exposed to temperatures in excess of 500° Fahrenheit.
- (6) Chains constructed of material less than  $\frac{5}{16}$  of an inch diameter shall not be used for load-carrying purposes unless otherwise approved.
- (7) Chains that have been lengthened, altered or repaired, shall, before being reused, be subjected to a load equal to their safeworking load and closely examined as to suitability for further use.
- (8) No chain shall be used that has been subjected to a severe shock.
- (9) No chain shall be heat-treated after being placed into commission.
- (10) No chain sling shall be used if the included angle measured between any 2 legs exceeds 150°, or if the angle formed between any sling leg and the line of action of the pull exceeds 75°.
- (11) Screw threads used in conjunction with chains shall be prevented by positive means from unscrewing.
- (12) No chain shall be used if any of its links are locked, or stretched, or are without free movement.
- (13) When a load is supported on more than 1 fall, single or part of chain, the load shall be distributed equally by statically determinate automatic means between the falls, singles or parts.
- (14) Every chain and every part of chain shall be of sound material, good construction, adequate strength, free from patent defects, and be suitable and safe for the purpose for which it is intended.

*Design, construction, use and safe working load*

- (15) Mild steel chains shall comply with the provisions of the British Standards Specification No 590, 1935, as revised in 1949, promulgated by the British Standards Institution, England.
- (16) Wrought iron chain shall comply with the provisions of the British Standard Specification No 394, as amended in 1944, or British Standard Specification No 465, 1932, promulgated by the British Standards Institution, England.
- (17) However—
- (a) every chain shall be classified numerically in conformity with the table entitled ‘Classification of Chain for Purposes of Design, Construction and Use’ after subsection (19); and
  - (b) in the event of uncertainty or dispute the classification may be determined by the chief inspector; and
  - (c) no chain shall be subjected to any greater load than that shown in table 143.1 as relevant and appropriate to its size and classification or way of use.
- (18) No chain shall be used if of other design or other material than provided in the British Standard Specifications published by the British Standards Institution, England, stated in subsections (15) and (16), without first being approved.
- (19) A chain shall not be subjected at any time to any greater load than is provided for that chain in this section, unless otherwise approved.

**Table 143.1 Classification of chain (for purposes of design, construction and use)**

classification of chain	classification of crane, hoist, lift, plant or scaffolding in connection with which the chain is used	chain used for other purposes
1	classifications 1 and 2	building, excavation or compressed air work

**Part 12** Plant and gear

Section 143

---

2 classifications 3 and 4

**Maximum safe working loads for chains—Classification 1**

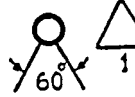
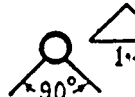
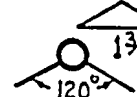
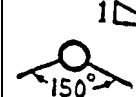
size of chain	safe load for 1 single fall (part) of chain		safe load for 2-leg sling arranged as indicated									
												
inches	tons	cwts	tons	cwts	tons	cwts	tons	cwts	tons	cwts	tons	cwts
5/16	0	12	1	3	1	1	0	17	0	12	0	6
3/8	0	17	1	13	1	9	1	4	0	17	0	9
7/16	1	3	2	4	2	0	1	13	1	3	0	12
1/2	1	10	2	18	2	12	2	2	1	10	0	16
9/16	1	18	3	13	3	6	2	14	1	18	1	0
5/8	2	7	4	11	4	1	3	6	2	7	1	4
11/16	2	17	5	10	4	19	4	1	2	17	1	10

Part 12 Plant and gear

Section 143

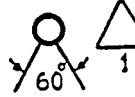
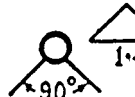
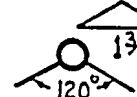
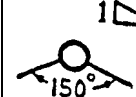
size of chain	safe load for 1 single fall (part) of chain		safe load for 2-leg sling arranged as indicated									
												
inches	tons	cwts	tons	cwts	tons	cwts	tons	cwts	tons	cwts	tons	cwts
3/4	3	8	6	11	5	18	4	16	3	8	1	15
13/16	4	0	7	15	6	18	5	13	4	0	2	1
7/8	4	12	8	18	7	19	6	10	4	12	2	8
15/16	5	6	10	5	9	4	7	10	5	6	2	15
1	6	0	11	12	10	8	8	10	6	0	3	2
1 1/16	6	16	13	3	11	16	9	12	6	16	3	10
1 1/8	7	12	14	14	13	4	10	15	7	12	3	19
1 3/16	8	10	16	8	14	14	12	0	8	10	4	8
1 1/4	9	8	18	4	16	6	13	6	9	8	4	17

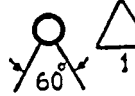
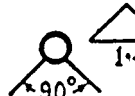
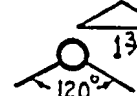
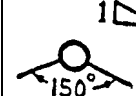

size of chain	safe load for 1 single fall (part) of chain		safe load for 2-leg sling arranged as indicated									
												
inches	tons	cwts	tons	cwts	tons	cwts	tons	cwts	tons	cwts	tons	cwts
15/16	10	7	20	0	17	19	14	13	10	7	5	7
13/8	11	7	21	18	19	13	16	1	11	7	5	18
17/16	12	8	23	19	21	9	17	10	12	8	6	8
1 1/2	13	10	26	1	23	8	19	2	13	10	7	0

**Maximum safe working loads for chains—Classification 2**

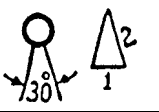
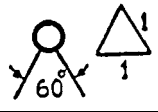
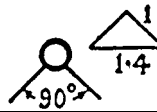
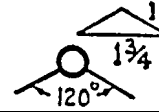
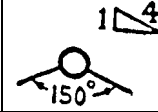
size of chain	safe load for 1 single fall (part) of chain		safe load for 2-leg sling arranged as indicated									
												
inches	tons	cwts	tons	cwts	tons	cwts	tons	cwts	tons	cwts	tons	cwts
5/16	0	10	0	19	0	17	0	14	0	10	0	5
3/8	0	14	1	7	1	4	1	0	0	14	0	7
7/16	0	19	1	17	1	13	1	7	0	19	0	10
1/2	1	5	2	8	2	3	1	15	1	5	0	13
9/16	1	11	3	0	2	14	2	4	1	11	0	16
5/8	1	18	3	13	3	6	2	14	1	18	1	0
11/16	2	6	4	9	4	0	3	5	2	6	1	4
3/4	2	15	5	6	4	15	3	18	2	15	1	8

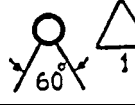
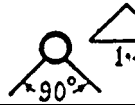
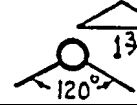
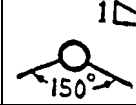
size of chain	safe load for 1 single fall (part) of chain		safe load for 2-leg sling arranged as indicated									
												
inches	tons	cwts	tons	cwts	tons	cwts	tons	cwts	tons	cwts	tons	cwts
13/16	3	5	6	5	5	13	4	12	3	5	1	14
7/8	3	15	7	5	6	10	5	6	3	15	1	19
15/16	4	6	8	6	7	9	6	2	4	6	2	4
1	4	18	9	9	8	10	6	19	4	18	2	11
11/16	5	10	10	13	9	11	7	16	5	10	2	17
1 1/8	6	4	12	0	10	15	8	15	6	4	3	4
13/16	6	15	13	0	11	14	9	11	6	15	3	10
1 1/4	7	13	14	15	13	5	10	16	7	13	3	19
15/16	8	9	16	6	14	13	11	19	8	9	4	7

Part 12 Plant and gear

Section 143

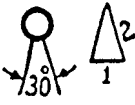
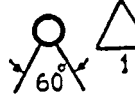
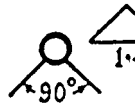
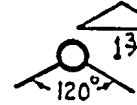
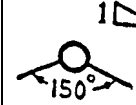
size of chain	safe load for 1 single fall (part) of chain		safe load for 2-leg sling arranged as indicated									
												
inches	tons	cwts	tons	cwts	tons	cwts	tons	cwts	tons	cwts	tons	cwts
1 3/8	9	6	18	0	16	2	13	3	9	6	4	16
1 7/16	10	2	19	10	17	10	14	6	10	2	5	5
1 1/2	11	0	21	5	19	2	15	11	11	0	5	14

**Maximum safe working load for chain used in chain blocks\*—Classification 1**

size of chain (inches)	safe working load per fall (part) of chain	
	tons	cwts
5/16	0	13
3/8	0	19
7/16	1	6
1/2	1	13
9/16	2	2

\* The overall width of the links of this chain must not exceed  $3\frac{1}{4}$  times the size of the chain.

**Maximum safe working load for chain used in chain blocks\*—Classification 2**

size of chain (inches)	safe working load per fall (part) of chain	
	tons	cwts
5/16	0	11
3/8	0	16
7/16	1	1
1/2	1	10
9/16	2	0

\* The overall width of the links of this chain must not exceed  $3\frac{1}{4}$  times the size of the chain.

*Drums, sheaves and quadrants for chain*

- (20) If chain is wound over or on drums, or over or on sheaves or quadrants that are not correctly pocketed, the drums, sheaves, and quadrants shall be grooved in an approved way and shall be not less in diameter than 24 times the size of the chain concerned.

*Swivel hooks for chain*

- (21) Lifting hooks, lifting eyes, attached to single falls (parts) of chain other than chain slings, shall be freely rotatable under all conditions of loading, and if the load exceeds 2 tons shall be of the ball or roller thrust-bearing type.
- (22) Provision shall be made to exclude dust and other foreign matter from thrust bearings.

*Guards for chain*

- (23) Guards shall be provided to prevent persons' hands or other parts of their body being injured by the chains and sheaves or gypsies of hook blocks or bottom blocks of power cranes or power hoists.

*Heat treatment*

- (24) Chains shall be heat-treated after manufacture before being used.
- (25) Mild steel chain shall be 'normalised', wrought iron chain shall be 'annealed'.
- (26) No chain shall be normalised or annealed after use except as provided in subsection (27).
- (27) When chain is required, the affected parts shall be normalised or annealed as aforesaid before reuse.

*Periodic inspection*

- (28) No person shall use any chain or any attachment of it unless every link and the attachments of it have been thoroughly cleaned and subjected to close, detailed examination at the intervals that are necessary or advisable to ascertain whether flaws, cracks, or other defects exist and to ensure that defective chains or attachments are not used.

- (29) A chain shall not be used if its links or attachments have flaws, cracks, or other defects liable to affect its safe use, or if the wear on any link or attachment exceeds 10% of the dimension measured.

*Testing of chain*

- (30) No person shall use any chain a part of which has not been tested in accordance with this section, or in relation to which the provisions of this section about the submitting of a test certificate or copy of the certificate have not been complied with.
- (31) Every person acquiring a chain for use shall within 24 hours of acquiring the chain, submit to the chief inspector a test certificate, correct in all particulars for a part of the chain, and the certificate shall be in accordance with schedule 2, form 14, and shall be signed by the manufacturer or vendor of the chain.
- (32) The manufacturer or vendor of a chain shall test at least 1 part of each 1 000 feet of chain made, or disposed of, by the manufacturer or vendor.
- (33) If the chain is electrically welded mild steel chain, the test shall comprise a breaking test of a 36 inch gauge length of chain and shall be carried out as prescribed by British Standard Specification No 590-1949 for electrically welded mild steel chain, promulgated by Standards Australia.
- (34) The test shall include determination of the energy absorption factor.
- (35) If the chain is of wrought iron, all of the tests prescribed by British Standard Specifications Nos. 465-1932 and 394-1944 shall be carried out.
- (36) Chains shown by the tests mentioned in subsection (35) to be deficient shall not be used.
- (37) No chain that is to be used shall be subjected to any proof or test load that exceeds by more than 25% the safe working load for the chain prescribed by this regulation.

- (38) If a chain has been made into shorter lengths than 1 000 feet and any person acquires for use any shorter length, the person shall, within 24 hours of acquiring the shorter length of chain, submit to the chief inspector a document that is a true copy of the test certificate correct in all particulars issued for the 1 000 feet length of chain mentioned in subsection (32) and signed by the manufacturer or vendor.
- (39) The document shall be accompanied by a statutory declaration of the manufacturer or vendor that it is a true copy of the original test certificate issued for the 1 000 feet length of chain.
- (40) The original test certificate must be signed by the person witnessing the test and the person must be the responsible testing officer of a licensed proving house, the testing officer of a government department or of a university or other approved engineering school, or the testing officer of a manufacturer of chain who has a testing machine on the manufacturer's premises approved for testing samples of the completed chain.

**Steel wire ropes for use in connection with cranes, lifts, hoists, scaffolding, plant, gear, or building work, excavation work, or compressed air work**

**144**

*General*

- (1) Reverse bends that are detrimental to the life of a running rope shall be avoided if practicable.
- (2) Suitable packing shall be provided and used to prevent wire rope coming in contact with sharp edges of loads or hard material.
- (3) Steel wire rope shall not be exposed to temperatures exceeding 200° Fahrenheit.
- (4) Steel wire rope of circumference less than  $\frac{5}{8}$  of an inch shall not be used for load carrying purposes unless otherwise approved.



- (5) Kinked ropes shall not be used.
- (6) Ropes shall be stored under cover in a clean, dry place and be raised clear of the ground.
- (7) In no case shall the rope be in contact with ashes, clinker or coke.
- (8) The ropes in store shall be examined periodically and the protective coating renewed when required.
- (9) When a load is supported on more than 1 fall, single or part of rope, the load shall be distributed equally by statically determinate automatic means between the various falls, singles or parts.
- (10) No rope shall be used for load carrying purposes that has been subjected to a severe shock or that has been unduly stretched.
- (11) No rope sling shall be used if the included angle measured between any 2 legs exceeds  $150^{\circ}$  or if the angle formed between any sling leg and the line of action of the pull exceeds  $75^{\circ}$ .
- (12) Rope slings before being used, and if repaired or altered before being reused, shall be subjected to a load equal to their safe working load and closely examined about suitability for use or reuse as the case may be.
- (13) Ropes having less than 6 strands, or having any strand containing less than 19 wires shall not be wound on drums or over or on sheaves, rollers, or quadrants, or used in any way as running ropes.
- (14) Screw threads used in conjunction with wire ropes shall be prevented by positive means from unscrewing.
- (15) If rope is used to support workers, it shall not be less than  $1\frac{1}{8}$  inches circumference and  $\frac{3}{8}$  of an inch diameter—if hand operated, or  $1\frac{5}{8}$  inches circumference and  $\frac{1}{2}$  an inch diameter—if power operated.
- (16) Every steel wire rope and every part of it shall be of sound material, good construction, adequate strength, free from patent defects, and be suitable and safe for the purpose for which it is intended.

- (17) Rope of lang lay shall not be used unless the ends are fixed to prevent unlaying of the rope.

*Design, construction, use and safe working load*

- (18) All steel wire rope shall comply with the provisions of Australian Standard Specification No B.9-1938, promulgated by Standards Australia.

- (19) However—

- (a) every steel wire ropes shall be classified numerically in conformity with table 144.1; and
- (b) in the event of uncertainty or dispute the classification may be determined by the chief inspector; and
- (c) no wire rope shall be subjected to any greater load than that shown in table 144.1 as relevant and appropriate to its circumference, construction, and classification, or way of use, provided that—
- (i) if it is of a grade of steel of greater or lesser minimum ultimate tensile value than 80 tons per square inch—the tabulated load shall be increased or decreased in the ratio:

$$\frac{\text{minimum ultimate tensile strength of steel of rope in tons per square inch}}{80}; \text{ and}$$

- (ii) if the rope is used solely as a static guy rope—the tabulated load may be increased by 50%; and
- (iii) if the rope comprises the main cable of a cableway—a further increase in load may be approved by the chief inspector; and

- (d) no steel wire rope shall be used if of other design or other material than provided in the British Standard Specifications promulgated by the British Standards Institution, England, or Australian Standard Specification No B9—1938 promulgated by Standards Australia, without first being approved.

**Table 144.1 Classification of steel wire rope for purposes of design, construction and use**

<b>classification of rope</b>	<b>classification of crane, hoist, lift, plant, or scaffolding in connection with which the steel wire rope is used</b>	<b>ropes used for other purposes</b>
1	classifications Nos 1, 2 and 3	building, excavation or compressed air work
2	classification No 4	

**Maximum safe working load for steel wire rope—Classification 1**

**Minimum ultimate tensile value of steel of which rope is constructed = 80 tons per square inch  
construction: 6 strands each containing 12 wires**

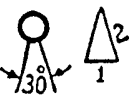
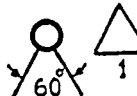
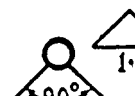
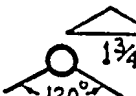
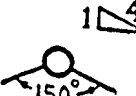
circumference of rope	approx. diameter of rope	safe load for 1 single fall (part) of rope		safe load for 2-leg sling arranged as indicated									
													
inches	inches	tons	cwts	tons	cwts	tons	cwts	tons	cwts	tons	cwts	tons	cwts
5/8	3/16	0	2 1/2	0	5	0	4	0	3 1/2	0	2 1/2	0	1 1/2
3/4	1/4	0	3 1/2	0	7	0	6	0	5	0	3 1/2	0	2
7/8	9/32	0	4 1/2	0	9	0	8	0	6 1/2	0	4 1/2	0	2 1/2
1	5/16	0	6	0	12	0	10	0	8 1/2	0	6	0	3
1 1/8	3/8	0	8	0	15	0	13	0	11	0	8	0	4

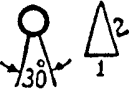
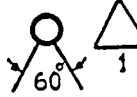
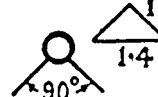
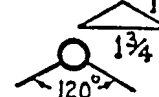
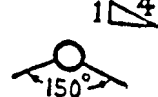
circumference of rope	approx. diameter of rope	safe load for 1 single fall (part) of rope		safe load for 2-leg sling arranged as indicated									
													
inches	inches	tons	cwts	tons	cwts	tons	cwts	tons	cwts	tons	cwts	tons	cwts
1 1/4	13/32	0	10	0	19	0	17	0	14	0	10	0	5
1 3/8	7/16	0	11	1	1	0	19	0	16	0	11	0	6
1 1/2	15/32	0	14	1	7	1	4	1	0	0	14	0	7
1 5/8	1/2	0	17	1	13	1	9	1	4	0	17	0	9
1 3/4	9/16	0	19	1	17	1	13	1	7	0	19	0	10
1 7/8	19/32	1	2	2	2	1	18	1	11	1	2	0	11
2	5/8	1	5	2	8	2	3	1	15	1	5	0	13
2 1/8	11/16	1	8	2	14	2	8	2	0	1	8	0	15
2 1/4	23/32	1	12	3	2	2	15	2	5	1	12	0	17
2 3/8	3/4	1	16	3	10	3	2	2	11	1	16	0	19
2 1/2	13/16	1	19	3	15	3	8	2	15	1	19	1	0

**Maximum safe working load for steel wire rope—Classification 2**

**Minimum ultimate tensile value of steel of which rope is constructed = 80 tons per square inch construction: 6 strands each containing 12 wires**

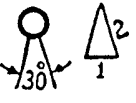
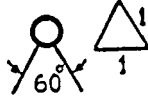
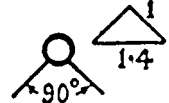
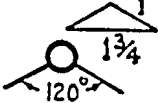
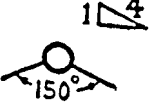
circumference of rope	approx. diameter of rope	safe load for 1 single fall (part) of rope		safe load for 2-leg sling arranged as indicated									
													
inches	inches	tons	cwts	tons	cwts	tons	cwts	tons	cwts	tons	cwts	tons	cwts
5/8	3/16	0	2	0	4	0	3 1/2	0	3	0	2	0	1
3/4	1/4	0	3	0	6	0	5	0	4	0	3	0	1 1/2
7/8	9/32	0	4	0	7 1/2	0	7	0	5 1/2	0	4	0	2
1	5/16	0	5	0	10	0	8 1/2	0	7	0	5	0	2 1/2
1 1/8	3/8	0	6 1/2	0	12 1/2	0	11	0	9	0	6 1/2	0	3 1/2

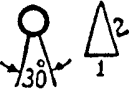
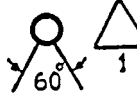
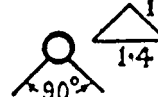
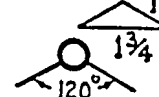
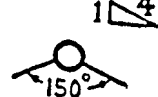
circumference of rope	approx. diameter of rope	safe load for 1 single fall (part) of rope		safe load for 2-leg sling arranged as indicated									
													
inches	inches	tons	cwts	tons	cwts	tons	cwts	tons	cwts	tons	cwts	tons	cwts
1 1/4	13/32	0	8 1/2	0	16 1/2	0	14 1/2	0	12	0	8 1/2	0	4 1/2
1 3/8	7/16	0	9 1/2	0	18 1/2	0	16 1/2	0	13 1/2	0	9 1/2	0	5
1 1/2	15/32	0	12	1	3	1	1	0	17	0	12	0	6
1 5/8	1/2	0	14 1/2	1	8	1	5	1	0	0	14 1/2	0	7 1/2
1 3/4	9/16	0	16	1	11	1	8	1	3	0	16	0	8 1/2
1 7/8	19/32	0	18 1/2	1	16	1	12	1	6	0	18 1/2	0	9 1/2
2	5/8	1	1	2	0	1	16	1	10	1	1	0	11
2 1/8	11/16	1	4	2	6	2	1	1	14	1	4	0	12 1/2
2 1/4	23/32	1	7	2	12	2	7	1	18	1	7	0	14
2 3/8	3/4	1	10	2	18	2	12	2	2	1	10	0	15 1/2

Part 12 Plant and gear

Section 144

circumference of rope	approx. diameter of rope	safe load for 1 single fall (part) of rope		safe load for 2-leg sling arranged as indicated									
				30°		60°		90°		120°		150°	
inches	inches	tons	cwts	tons	cwts	tons	cwts	tons	cwts	tons	cwts	tons	cwts
2 1/2	13/16	1	13	3	4	2	17	2	7	1	13	0	17



**Maximum safe working load for steel wire rope—Classification 1**

**Minimum ultimate tensile value of steel of which rope is constructed = 80 tons per square inch  
construction: Six strands each containing nineteen wires**

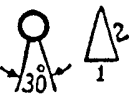
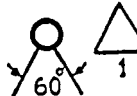
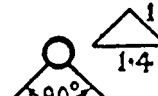
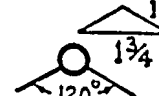
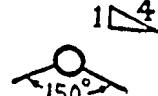
circumference of rope	approx. diameter of rope	safe load for 1 single fall (part) of rope		safe load for 2-leg sling arranged as indicated									
													
inches	inches	tons	cwts	tons	cwts	tons	cwts	tons	cwts	tons	cwts	tons	cwts
5/8	3/16	0	3 1/2	0	7	0	6	0	5	0	3 1/2	0	2
3/4	1/4	0	5 1/2	0	10 1/2	0	9 1/2	0	8	0	5 1/2	0	3
7/8	9/32	0	7	0	13 1/2	0	12	0	10	0	7	0	3 1/2
1	5/16	0	9 1/2	0	18	0	16	0	13	0	9 1/2	0	5
1 1/8	3/8	0	11	1	1	0	19	0	15 1/2	0	11	0	6
1 1/4	13/32	0	14 1/2	1	7	1	5	1	0	0	14 1/2	0	7

Part 12 Plant and gear

Section 144

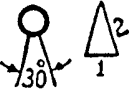
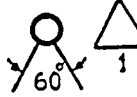
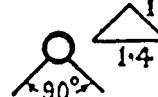
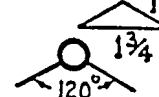
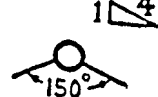
circumference of rope	approx. diameter of rope	safe load for 1 single fall (part) of rope		safe load for 2-leg sling arranged as indicated									
													
inches	inches	tons	cwts	tons	cwts	tons	cwts	tons	cwts	tons	cwts	tons	cwts
3/8 1	7/16	0	16 1/2	1	12	1	9	1	3	0	16 1/2	0	8 1/2
1 1/2	15/32	1	0	1	18	1	14	1	8	1	0	0	10
5/8 1	1/2	1	4	2	6	2	1	1	14	1	4	0	12
1 3/4	9/16	1	7	2	12	2	7	1	18	1	7	0	14
7/8 1	19/32	1	12	3	2	2	15	2	5	1	12	0	16 1/2
2	5/8	1	17	3	11	3	4	2	12	1	17	0	19
2 1/8	11/16	2	1	3	19	3	11	2	18	2	1	1	1
2 1/4	23/32	2	6	4	9	4	0	3	5	2	6	1	4
2 3/8	3/4	2	12	5	0	4	10	3	14	2	12	1	7

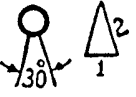
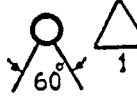
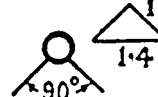
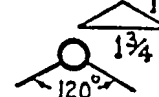
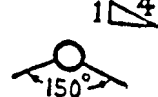
circumference of rope	approx. diameter of rope	safe load for 1 single fall (part of rope)		safe load for 2-leg sling arranged as indicated									
													
inches	inches	tons	cwts	tons	cwts	tons	cwts	tons	cwts	tons	cwts	tons	cwts
2 1/2	13/16	2	16	5	8	4	18	4	0	2	17	1	9
2 3/4	7/8	3	8	6	12	5	18	4	16	3	8	1	15
3	15/16	4	3	8	6	7	9	6	1	4	3	2	4
3 1/4	1 1/16	5	0	9	13	8	13	7	1	5	0	2	12
3 1/2	1 1/8	5	18	11	8	10	5	8	7	5	18	3	1
3 3/4	1 3/16	6	14	13	0	11	13	9	10	6	14	3	10
4	1 1/4	7	12	14	13	13	3	10	15	7	12	3	18
4 1/4	1 3/8	8	10	16	9	14	15	12	1	8	10	4	8
4 1/2	1 7/16	9	13	18	14	16	15	13	14	9	13	5	0

Part 12 Plant and gear

Section 144

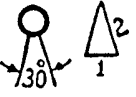
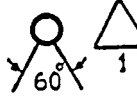
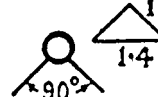
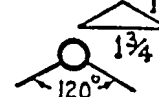
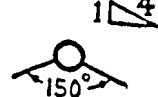
circumference of rope	approx. diameter of rope	safe load for 1 single fall (part) of rope		safe load for 2-leg sling arranged as indicated									
													
inches	inches	tons	cwts	tons	cwts	tons	cwts	tons	cwts	tons	cwts	tons	cwts
4 <sup>3</sup> / <sub>4</sub>	1 <sup>1</sup> / <sub>2</sub>	10	14	20	14	18	11	15	3	10	14	5	11
5	1 <sup>5</sup> / <sub>8</sub>	11	16	22	16	20	9	16	14	11	16	6	2
5 <sup>1</sup> / <sub>4</sub>	1 <sup>11</sup> / <sub>16</sub>	13	3	25	9	22	17	18	13	13	3	6	16
5 <sup>1</sup> / <sub>2</sub>	1 <sup>3</sup> / <sub>4</sub>	14	8	27	16	24	19	20	7	14	8	7	9
5 <sup>3</sup> / <sub>4</sub>	1 <sup>13</sup> / <sub>16</sub>	15	13	30	4	27	2	22	2	15	13	8	2
6	1 <sup>7</sup> / <sub>8</sub>	17	4	33	5	29	16	24	7	17	4	8	18

**Maximum safe working load for steel wire rope—Classification 2**

**Minimum ultimate tensile value of steel of which rope is constructed = 80 tons per square inch construction: 6 strands each containing 19 wires**

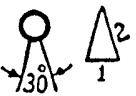
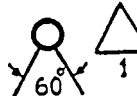
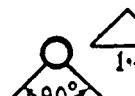
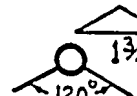
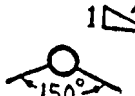
circumference of rope	approx. diameter of rope	safe load for 1 single fall (part) of rope		safe load for 2-leg sling arranged as indicated									
													
inches	inches	tons	cwts	tons	cwts	tons	cwts	tons	cwts	tons	cwts	tons	cwts
5/8	3/16	0	3	0	6	0	5	0	4	0	3	0	1 1/2
3/4	1/4	0	4 1/2	0	8 1/2	0	8	0	6 1/2	0	4 1/2	0	2 1/2
7/8	9/32	0	6	0	11 1/2	0	10 1/2	0	8 1/2	0	6	0	3
1	5/16	0	8	0	15 1/2	0	14	0	11	0	8	0	4
1 1/8	3/8	0	9 1/2	0	18 1/2	0	16 1/2	0	13 1/2	0	9 1/2	0	5
1 1/4	13/32	0	12	1	3	1	1	0	17	0	12	0	6

Part 12

Plant and gear

Section 144

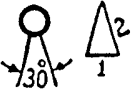
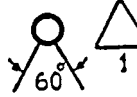
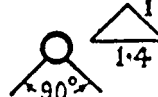
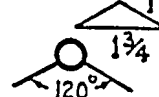
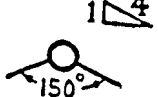
circumference of rope	approx. diameter of rope	safe load for 1 single fall (part) of rope		safe load for 2-leg sling arranged as indicated									
													
inches	inches	tons	cwts	tons	cwts	tons	cwts	tons	cwts	tons	cwts	tons	cwts
3/8 1	7/16	0	14	1	7	1	4	0	19 1/2	0	14	0	7
1 1/2	15/32	0	17	1	13	1	9	1	4	0	17	0	8 1/2
5/8 1	1/2	1	0	1	19	1	15	1	8	1	0	0	10
1 3/4	9/16	1	3	2	4	2	0	1	12	1	3	0	12
7/8 1	19/32	1	7	2	12	2	7	1	18	1	7	0	14
2	5/8	1	11	3	0	2	14	2	4	1	11	0	16
2 1/8	11/16	1	15	3	7	3	0	2	9	1	15	0	18
2 1/4	23/32	1	19	3	15	3	7	2	15	1	19	1	0
2 3/8	3/4	2	4	4	5	3	16	3	2	2	4	1	3

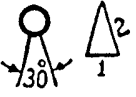
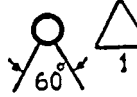
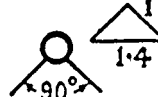
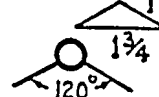
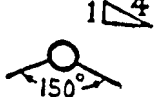
circumference of rope	approx. diameter of rope	safe load for 1 single fall (part) of rope		safe load for 2-leg sling arranged as indicated									
													
inches	inches	tons	cwts	tons	cwts	tons	cwts	tons	cwts	tons	cwts	tons	cwts
2 1/2	13/16	2	7	4	11	4	1	3	7	2	7	1	5
2 3/4	7/8	2	17	5	10	4	19	4	1	2	17	1	9
3	15/16	3	10	6	15	6	1	4	19	3	10	1	16
3 1/4	1 1/16	4	4	8	2	7	6	5	19	4	4	2	4
3 1/2	1 1/8	5	0	9	13	8	13	7	1	5	0	2	12
3 3/4	1 3/16	5	13	11	0	9	16	8	0	5	13	2	19
4	1 1/4	6	8	12	8	11	2	9	1	6	8	3	6
4 1/4	1 3/8	7	3	13	16	12	8	10	2	7	3	3	14
4 1/2	1 7/16	8	2	15	13	14	1	11	9	8	2	4	4

Part 12 Plant and gear

Section 144

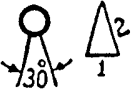
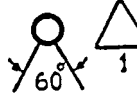
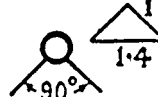
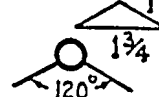
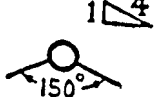
circumference of rope	approx. diameter of rope	safe load for 1 single fall (part) of rope		safe load for 2-leg sling arranged as indicated									
													
inches	inches	tons	cwts	tons	cwts	tons	cwts	tons	cwts	tons	cwts	tons	cwts
4 <sup>3</sup> / <sub>4</sub>	1 <sup>1</sup> / <sub>2</sub>	9	0	17	8	15	12	12	14	9	0	4	13
5	1 <sup>5</sup> / <sub>8</sub>	9	19	19	4	17	5	14	1	9	19	5	3
5 <sup>1</sup> / <sub>4</sub>	1 <sup>11</sup> / <sub>16</sub>	11	2	21	9	19	4	15	14	11	2	5	15
5 <sup>1</sup> / <sub>2</sub>	1 <sup>3</sup> / <sub>4</sub>	12	2	23	7	20	19	17	2	12	2	6	5
5 <sup>3</sup> / <sub>4</sub>	1 <sup>13</sup> / <sub>16</sub>	13	4	25	10	22	17	18	14	13	4	6	17
6	1 <sup>7</sup> / <sub>8</sub>	14	10	28	0	25	2	20	10	14	10	7	10



**Maximum safe working load for steel wire rope—Classification 1**

**Minimum ultimate tensile value of steel of which rope is constructed = 80 tons per square inch construction: 6 strands each containing 24 wires**

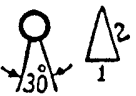
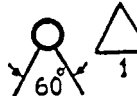
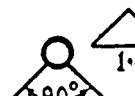
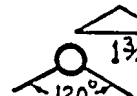
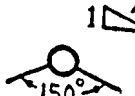
circumference of rope	approx. diameter of rope	safe load for 1 single fall (part) of rope		safe load for 2-leg sling arranged as indicated									
													
inches	inches	tons	cwts	tons	cwts	tons	cwts	tons	cwts	tons	cwts	tons	cwts
5/8	3/16	0	3	0	6	0	5	0	4	0	3	0	1 1/2
3/4	1/4	0	4 1/2	0	8 1/2	0	8	0	6 1/2	0	4 1/2	0	2 1/2
7/8	9/32	0	6	0	11 1/2	0	10 1/2	0	8 1/2	0	6	0	3
1	5/16	0	8	0	15	0	14	0	11 1/2	0	8	0	4
1 1/8	3/8	0	11	1	1	0	19	0	15 1/2	0	11	0	5 1/2
1 1/4	13/32	0	13	1	5	1	3	0	18 1/2	0	13	0	7

Part 12 Plant and gear

Section 144

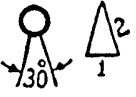
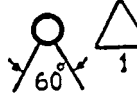
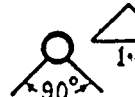
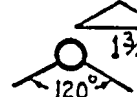
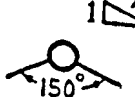
circumference of rope	approx. diameter of rope	safe load for 1 single fall (part) of rope		safe load for 2-leg sling arranged as indicated									
													
inches	inches	tons	cwts	tons	cwts	tons	cwts	tons	cwts	tons	cwts	tons	cwts
3/8 1	7/16	0	16	1	11	1	8	1	3	0	16	0	8
1 1/2	15/32	0	19	1	17	1	13	1	7	0	19	0	10
5/8 1	1/2	1	2	2	3	1	18	1	11	1	2	0	11 1/2
1 3/4	9/16	1	5	2	8	2	3	1	15	1	5	0	13
7/8 1	19/32	1	9	2	16	2	10	2	1	1	9	0	15
2	5/8	1	14	3	6	2	19	2	8	1	14	0	17 1/2
2 1/8	11/16	1	18	3	13	3	6	2	14	1	18	0	19 1/2
2 1/4	23/32	2	2	4	2	3	14	3	0	2	2	1	2
2 3/8	3/4	2	7	4	11	4	1	3	6	2	7	1	4

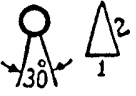
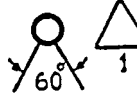
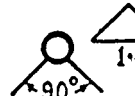
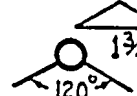
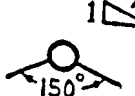
circumference of rope	approx. diameter of rope	safe load for 1 single fall (part) of rope		safe load for 2-leg sling arranged as indicated									
													
inches	inches	tons	cwts	tons	cwts	tons	cwts	tons	cwts	tons	cwts	tons	cwts
2 1/2	13/16	2	14	5	5	4	14	3	17	2	14	1	8
2 3/4	7/8	3	4	6	4	5	11	4	11	3	4	1	13
3	15/16	3	15	7	6	6	11	5	7	3	15	1	19
3 1/4	1 1/16	4	11	8	16	7	17	6	8	4	11	2	7
3 1/2	1 1/8	5	4	10	1	9	0	7	7	5	4	2	12
3 3/4	1 3/16	5	18	11	8	10	5	8	7	5	18	3	1
4	1 1/4	6	17	13	5	11	18	9	14	6	17	3	11
4 1/4	1 3/8	7	13	14	16	13	5	10	17	7	13	3	19
4 1/2	1 7/16	8	10	16	10	14	15	12	1	8	10	4	8

Part 12 Plant and gear

Section 144

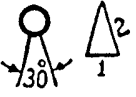
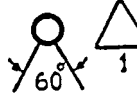
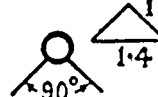
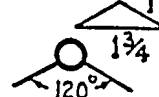
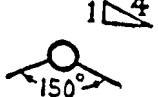
circumference of rope	approx. diameter of rope	safe load for 1 single fall (part) of rope		safe load for 2-leg sling arranged as indicated									
													
inches	inches	tons	cwts	tons	cwts	tons	cwts	tons	cwts	tons	cwts	tons	cwts
4 <sup>3</sup> / <sub>4</sub>	1 <sup>1</sup> / <sub>2</sub>	9	13	18	13	16	14	13	13	9	13	5	0
5	1 <sup>5</sup> / <sub>8</sub>	10	12	20	9	18	7	15	0	10	12	5	9
5 <sup>1</sup> / <sub>4</sub>	1 <sup>11</sup> / <sub>16</sub>	11	12	22	8	20	2	16	8	11	12	6	0
5 <sup>1</sup> / <sub>2</sub>	1 <sup>3</sup> / <sub>4</sub>	12	12	24	8	21	17	17	17	12	12	6	10
5 <sup>3</sup> / <sub>4</sub>	1 <sup>13</sup> / <sub>16</sub>	14	0	27	1	24	5	19	16	14	0	7	5
6	1 <sup>7</sup> / <sub>8</sub>	15	3	29	6	26	5	21	9	15	3	7	16

**Maximum safe working load for steel wire rope—Classification 2**

**Minimum ultimate tensile value of steel of which rope is constructed = 80 tons per square inch construction: 6 strands each containing 24 wires**

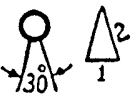
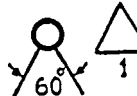
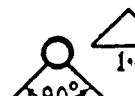
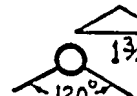
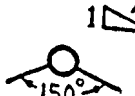
circumference of rope	approx. diameter of rope	safe load for 1 single fall (part) of rope		safe load for 2-leg sling arranged as indicated									
													
inches	inches	tons	cwts	tons	cwts	tons	cwts	tons	cwts	tons	cwts	tons	cwts
5/8	3/16	0	2 1/2	0	5	0	4 1/2	0	3 1/2	0	2 1/2	0	1 1/2
3/4	1/4	0	4	0	7 1/2	0	7	0	5 1/2	0	4	0	2
7/8	9/32	0	5	0	9 1/2	0	8 1/2	0	7	0	5	0	2 1/2
1	5/16	0	7	0	13 1/2	0	12	0	10	0	7	0	3 1/2
1 1/8	3/8	0	9 1/2	0	18 1/2	0	16 1/2	0	13 1/2	0	9 1/2	0	5
1 1/4	13/32	0	11	1	1	0	19	0	15 1/2	0	11	0	5 1/2

Part 12

Plant and gear

Section 144

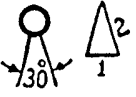
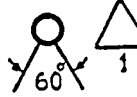
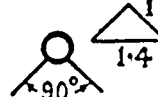
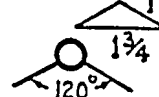
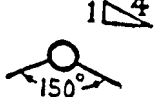
circumference of rope	approx. diameter of rope	safe load for 1 single fall (part) of rope		safe load for 2-leg sling arranged as indicated									
													
inches	inches	tons	cwts	tons	cwts	tons	cwts	tons	cwts	tons	cwts	tons	cwts
3/8 1	7/16	0	13 1/2	1	6	1	3	0	19	0	13 1/2	0	7
1 1/2	15/32	0	16	1	11	1	8	1	3	0	16	0	8
5/8 1	1/2	0	19	1	17	1	13	1	7	0	19	0	10
1 3/4	9/16	1	1	2	1	1	16	1	10	1	1	0	11
7/8 1	19/32	1	5	2	8	2	3	1	15	1	5	0	13
2	5/8	1	9	2	16	2	10	2	1	1	9	0	15
2 1/8	11/16	1	12	3	2	2	15	2	5	1	12	0	16 1/2
2 1/4	23/32	1	16	3	10	3	2	2	11	1	16	0	18 1/2
2 3/8	3/4	2	0	3	17	3	9	2	17	2	0	1	1

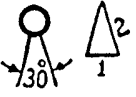
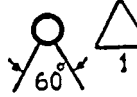
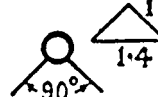
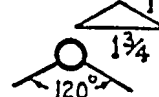
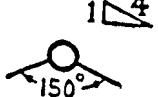
circumference of rope	approx. diameter of rope	safe load for 1 single fall (part) of rope		safe load for 2-leg sling arranged as indicated									
													
inches	inches	tons	cwts	tons	cwts	tons	cwts	tons	cwts	tons	cwts	tons	cwts
2 1/2	13/16	2	6	4	9	4	0	3	5	2	6	1	4
2 3/4	7/8	2	14	5	4	4	14	3	16	2	14	1	8
3	15/16	3	3	6	2	5	9	4	9	3	3	1	13
3 1/4	1 1/16	3	17	7	9	6	13	5	9	3	17	2	0
3 1/2	1 1/8	4	8	8	10	7	13	6	4	4	8	2	6
3 3/4	1 3/16	5	0	9	13	8	13	7	1	5	0	2	12
4	1 1/4	5	15	11	2	9	19	8	3	5	15	3	0
4 1/4	1 3/8	6	9	12	9	11	4	9	3	6	9	3	7
4 1/2	1 7/16	7	3	13	16	12	8	10	2	7	3	3	14

Part 12 Plant and gear

Section 144

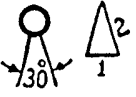
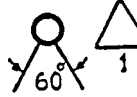
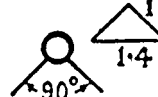
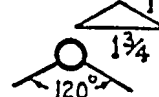
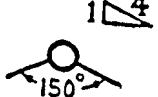
circumference of rope	approx. diameter of rope	safe load for 1 single fall (part) of rope		safe load for 2-leg sling arranged as indicated									
													
inches	inches	tons	cwts	tons	cwts	tons	cwts	tons	cwts	tons	cwts	tons	cwts
4 <sup>3</sup> / <sub>4</sub>	1 <sup>1</sup> / <sub>2</sub>	8	3	15	15	14	2	11	10	8	3	4	5
5	1 <sup>5</sup> / <sub>8</sub>	8	19	17	6	15	10	12	13	8	19	4	13
5 <sup>1</sup> / <sub>4</sub>	1 <sup>11</sup> / <sub>16</sub>	9	15	18	17	16	18	13	16	9	15	5	1
5 <sup>1</sup> / <sub>2</sub>	1 <sup>3</sup> / <sub>4</sub>	10	12	20	10	18	7	15	0	10	12	5	11
5 <sup>3</sup> / <sub>4</sub>	1 <sup>13</sup> / <sub>16</sub>	11	16	22	16	20	9	16	14	11	16	6	2
6	1 <sup>7</sup> / <sub>8</sub>	12	15	24	12	22	2	18	1	12	15	6	12



**Maximum safe working load for steel wire rope—Classification 1**

**Minimum ultimate tensile value of steel of which rope is constructed = 80 tons per square inch  
construction: 6 strands each containing 37 wires**

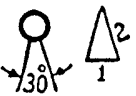
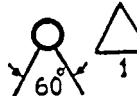
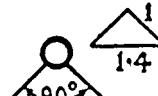
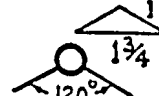
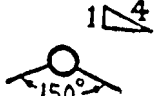
circumference of rope	approx. diameter of rope	safe load for 1 single fall (part) of rope		safe load for 2-leg sling arranged as indicated									
													
inches	inches	tons	cwts	tons	cwts	tons	cwts	tons	cwts	tons	cwts	tons	cwts
1	5/16	0	8 1/2	0	16	0	15	0	12	0	8 1/2	0	4 1/2
1/8 1	3/8	0	11 1/2	1	2	1	0	0	16 1/2	0	11 1/2	0	6
1 1/4	13/32	0	13	1	5	1	2 1/2	0	18 1/2	0	13	0	7
3/8 1	7/16	0	15 1/2	1	10	1	7	1	2	0	15 1/2	0	8
1 1/2	15/32	0	19	1	17	1	13	1	7	0	19	0	10
5/8 1	1/2	1	3	2	2	2	0	1	13	1	3	0	12

Part 12 Plant and gear

Section 144

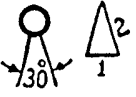
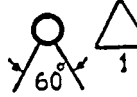
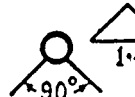
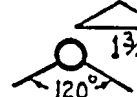
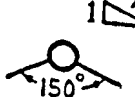
circumference of rope	approx. diameter of rope	safe load for 1 single fall (part) of rope		safe load for 2-leg sling arranged as indicated									
													
inches	inches	tons	cwts	tons	cwts	tons	cwts	tons	cwts	tons	cwts	tons	cwts
1 3/4	9/16	1	6	2	11	2	6	1	18	1	6	0	13 1/2
7/8 1	19/32	1	10	2	18	2	12	2	2	1	10	0	15 1/2
2	5/8	1	15	3	9	3	2	2	10	1	15	0	18
2 1/8	11/16	2	0	3	17	3	9	2	17	2	0	1	1
2 1/4	23/32	2	6	4	9	4	0	3	5	2	6	1	4
2 3/8	3/4	2	9	4	15	4	5	3	9	2	9	1	6
2 1/2	13/16	2	14	5	4	4	13	3	16	2	14	1	8
2 3/4	7/8	3	6	6	8	5	15	4	14	3	6	1	14
3	15/16	4	0	7	15	6	19	5	13	4	0	2	1

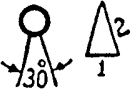
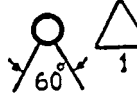
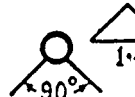
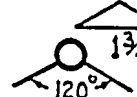
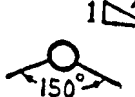
circumference of rope	approx. diameter of rope	safe load for 1 single fall (part) of rope		safe load for 2-leg sling arranged as indicated									
													
inches	inches	tons	cwts	tons	cwts	tons	cwts	tons	cwts	tons	cwts	tons	cwts
3 <sup>1</sup> / <sub>4</sub>	1 <sup>1</sup> / <sub>16</sub>	4	11	8	16	7	18	6	9	4	11	2	7
3 <sup>1</sup> / <sub>2</sub>	1 <sup>1</sup> / <sub>8</sub>	5	7	10	7	9	6	7	12	5	7	2	15
3 <sup>3</sup> / <sub>4</sub>	1 <sup>3</sup> / <sub>16</sub>	6	4	12	0	10	15	8	16	6	4	3	4
4	1 <sup>1</sup> / <sub>4</sub>	7	2	13	15	12	7	10	2	7	2	3	14
4 <sup>1</sup> / <sub>4</sub>	1 <sup>3</sup> / <sub>8</sub>	8	2	15	13	14	1	11	9	8	2	4	4
4 <sup>1</sup> / <sub>2</sub>	1 <sup>7</sup> / <sub>16</sub>	8	18	17	4	15	8	12	12	8	18	4	12
4 <sup>3</sup> / <sub>4</sub>	1 <sup>1</sup> / <sub>2</sub>	10	0	19	6	17	6	14	3	10	0	5	3
5	1 <sup>5</sup> / <sub>8</sub>	11	3	21	11	19	6	15	15	11	3	5	15
5 <sup>1</sup> / <sub>4</sub>	1 <sup>11</sup> / <sub>16</sub>	12	7	23	17	21	8	17	10	12	7	6	8
5 <sup>1</sup> / <sub>2</sub>	1 <sup>3</sup> / <sub>4</sub>	13	6	25	14	23	1	18	16	13	6	6	17

Part 12 Plant and gear

Section 144

circumference of rope	approx. diameter of rope	safe load for 1 single fall (part) of rope		safe load for 2-leg sling arranged as indicated									
				30°		60°		90°		120°		150°	
inches	inches	tons	cwts	tons	cwts	tons	cwts	tons	cwts	tons	cwts	tons	cwts
5 <sup>3</sup> / <sub>4</sub>	1 <sup>13</sup> / <sub>16</sub>	14	13	28	6	25	7	20	14	14	13	7	11
6	1 <sup>7</sup> / <sub>8</sub>	16	1	31	0	27	16	22	14	16	1	8	6

**Maximum safe working load for steel wire rope—Classification 2**

**Minimum ultimate tensile value of steel of which rope is constructed = 80 tons per square inch construction: 6 strands each containing 37 wires**

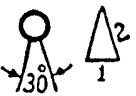
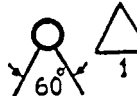
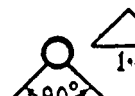
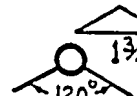
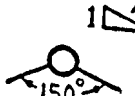
circumference of rope	approx. diameter of rope	safe load for 1 single fall (part) of rope		safe load for 2-leg sling arranged as indicated									
													
inches	inches	tons	cwts	tons	cwts	tons	cwts	tons	cwts	tons	cwts	tons	cwts
1	5/16	0	7	0	13 1/2	0	12	0	10	0	7	0	4
1/8 1	3/8	0	9	0	17 1/2	0	15 1/2	0	13	0	9	0	5
1 1/4	13/32	0	11	1	1	0	19	0	15 1/2	0	11	0	5 1/2
3/8 1	7/16	0	13	1	5	1	3	0	18 1/2	0	13	0	6 1/2
1 1/2	15/32	0	16	1	11	1	8	1	3	0	16	0	8 1/2
5/8 1	1/2	0	19 1/2	1	18	1	14	1	8	0	19 1/2	0	10

Part 12 Plant and gear

Section 144

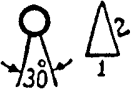
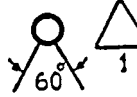
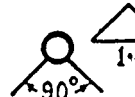
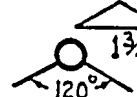
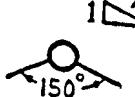
circumference of rope	approx. diameter of rope	safe load for 1 single fall (part) of rope		safe load for 2-leg sling arranged as indicated									
													
inches	inches	tons	cwts	tons	cwts	tons	cwts	tons	cwts	tons	cwts	tons	cwts
1 3/4	9/16	1	2	2	2	1	18	1	11	1	2	0	11 1/2
7/8 1	19/32	1	6	2	10	2	5	1	17	1	6	0	13 1/2
2	5/8	1	10	2	18	2	12	2	2	1	10	0	15 1/2
2 1/8	11/16	1	14	3	6	2	19	2	8	1	14	0	17 1/2
2 1/4	23/32	1	19	3	15	3	7	2	15	1	19	1	0
2 3/8	3/4	2	1	3	19	3	11	2	18	2	1	1	1
2 1/2	13/16	2	5	4	7	3	18	3	4	2	5	1	3
2 3/4	7/8	2	16	5	8	4	17	3	19	2	16	1	9
3	15/16	3	7	6	10	5	16	4	15	3	7	1	15

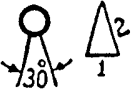
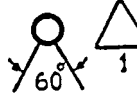
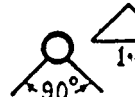
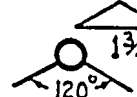
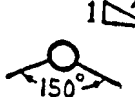
circumference of rope	approx. diameter of rope	safe load for 1 single fall (part) of rope		safe load for 2-leg sling arranged as indicated									
													
inches	inches	tons	cwts	tons	cwts	tons	cwts	tons	cwts	tons	cwts	tons	cwts
3 <sup>1</sup> / <sub>4</sub>	1 <sup>1</sup> / <sub>16</sub>	3	17	7	9	6	13	5	9	3	17	2	0
3 <sup>1</sup> / <sub>2</sub>	1 <sup>1</sup> / <sub>8</sub>	4	10	8	14	7	16	6	7	4	10	2	7
3 <sup>3</sup> / <sub>4</sub>	1 <sup>3</sup> / <sub>16</sub>	5	5	10	3	9	2	7	9	5	5	2	14
4	1 <sup>1</sup> / <sub>4</sub>	6	0	11	12	10	8	8	10	6	0	3	2
4 <sup>1</sup> / <sub>4</sub>	1 <sup>3</sup> / <sub>8</sub>	6	17	13	4	11	18	9	14	6	17	3	11
4 <sup>1</sup> / <sub>2</sub>	1 <sup>7</sup> / <sub>16</sub>	7	10	14	10	13	0	10	12	7	10	3	18
4 <sup>3</sup> / <sub>4</sub>	1 <sup>1</sup> / <sub>2</sub>	8	9	16	8	14	13	11	19	8	9	4	8
5	1 <sup>5</sup> / <sub>8</sub>	9	8	18	3	16	6	13	6	9	8	4	17
5 <sup>1</sup> / <sub>4</sub>	1 <sup>11</sup> / <sub>16</sub>	10	8	20	2	18	0	14	14	10	8	5	8
5 <sup>1</sup> / <sub>2</sub>	1 <sup>3</sup> / <sub>4</sub>	11	4	21	12	19	8	15	17	11	4	5	16

Part 12 Plant and gear

Section 144

circumference of rope	approx. diameter of rope	safe load for 1 single fall (part) of rope		safe load for 2-leg sling arranged as indicated									
				30°		60°		90°		120°		150°	
inches	inches	tons	cwts	tons	cwts	tons	cwts	tons	cwts	tons	cwts	tons	cwts
5 <sup>3</sup> / <sub>4</sub>	1 <sup>13</sup> / <sub>16</sub>	12	7	23	17	21	7	17	9	12	7	6	8
6	1 <sup>7</sup> / <sub>8</sub>	13	10	26	1	23	8	19	2	13	10	7	0



*Ratio of drum (barrel) or sheave diameter to rope*

- (20) When power operated and for rope speeds not greater than 120 feet per minute, the diameter of a drum (barrel) roller, sheave or quadrant measured at the surface on which the rope operates (where ungrooved) or at the bottom of the groove (where grooved) shall be not less than that provided in table 144.2 as relevant and appropriate to the construction of the rope concerned.
- (21) For each increase in rope speed of 60 feet per minute, above 120 feet per minute,  $7\frac{1}{2}\%$  shall be added to the diameter of the drum, barrel, roller, sheave or quadrant.
- (22) The ratio of drum, barrel, roller, sheave or quadrant diameter to rope diameter when hand operated shall be not less than 10, when measured at the surface on which the rope operates.

**Table 144.2**

number of strands	rope construction		minimum diameter of drum, barrel, roller, sheave or quadrant expressed in terms of 'd' the diameter of the rope concerned
	number of wires in each strand	note	
4	37		23d.
6	16		
6	17		
6	19		
6	22		19d.
6	24		
6	37		16 $\frac{1}{2}$ d.
6	61		15 $\frac{1}{2}$ d.

rope construction			minimum diameter of drum, barrel, roller, sheave or quadrant expressed in terms of 'd' the diameter of the rope concerned
number of strands	number of wires in each strand	note	
6	10	flattened strand	33d.
6	25	flattened strand	27d.
6	27	flattened strand	25d.
8	19	flattened strand	17 <sup>1</sup> / <sub>2</sub> d.
17	7	non-spin	20d.
34	7	non-spin	16 <sup>1</sup> / <sub>2</sub> d.

*Equalising sheaves*

- (23) Equalising sheaves and analogous media shall have diameters at the bottoms of the grooves not less than 15 times the diameter of the ropes concerned.

*Angle of lead of rope to and from drums or sheaves—for grooved drums or sheaves*

- (24) The maximum lead angle shall be such that there is no danger of the rope being drawn out of its bed in the groove and shall not exceed 5° (1 in 12) each side of a plane perpendicular to the axis of rotation of the drum or sheave.

*Angle of lead of rope to and from drums or sheaves—for ungrooved drums*

- (25) The maximum lead angle shall be such that there is no danger of the rope 'bunching' on the drum and failing to lay correctly on it, and shall not exceed 3° (1 in 19) each side of a plane perpendicular to the axis of rotation of the drum.

*Grooving of drums*

- (26) If drums are grooved the grooves shall be machined and the contour at the bottom of the grooves shall be circular over an angle of 120°.
- (27) The radius of the grooves shall be as shown in table 144.3.

**Table 144.3 Radius of grooves in rope drums**

for ropes up to and including 2 inches circumference	radius of rope plus $\frac{1}{32}$ of an inch
for ropes of $2\frac{1}{8}$ to $2\frac{3}{4}$ inches circumference inclusive	radius of rope plus $\frac{3}{64}$ of an inch
for ropes of 3 to $3\frac{1}{2}$ inches circumference inclusive	radius of rope plus $\frac{1}{16}$ of an inch
for ropes of $3\frac{3}{4}$ inches circumference and larger	radius of rope plus $\frac{3}{32}$ of an inch

- (28) Grooves shall have a depth of not less than  $\frac{1}{3}$  of the diameter of the rope and shall be so pitched that there is a clearance of not less than  $\frac{1}{32}$  of an inch for ropes up to  $1\frac{1}{2}$  inches diameter and not less than  $\frac{1}{16}$  of an inch for ropes over  $1\frac{1}{2}$  inches diameter, between the parts of the rope when coiled on the drum.
- (29) The grooves shall be smoothly finished and all sharp edges removed.

*Ungrooved drums for rope*

- (30) Ungrooved drums shall have flanges extending 1 rope diameter above the surface of the outer layer of rope when the maximum designed number of turns are wound on it, but in no case shall the total depth of the flange measured from the face of the empty drum be less than 3 rope diameters.

- (31) Subsection (30) shall not imply that an additional flange is to be provided when a wheel that is attached to the drum will serve to form 1 of the flanges.

*Rope pulleys and quadrants*

- (32) Rope pulleys and quadrants shall be machine grooved to a depth not less than  $1\frac{1}{2}$  times the diameter of the rope used on it and the grooving shall comply with the provisions of subsections (26) to (29).
- (33) The included angle of flare between the 2 sides of the grooving of a pulley or quadrant shall be not less than  $42^\circ$  and not more than  $52^\circ$ .
- (34) When ropes are prevented from leaving their grooves, the grooves may be not less in depth than the diameter of the rope concerned.
- (35) Lifting block pulleys shall be provided with suitable guards to keep the ropes in the grooves.

*Swivel hooks*

- (36) Lifting hooks and lifting eyes attached to single falls (parts) of steel wire rope other than rope slings, shall be freely rotatable under all conditions of loading and if the load exceeds 2 tons shall be of the ball or roller thrust bearing type.
- (37) Provision shall be made to exclude dust and other foreign matter from thrust bearings.

*Guards*

- (38) Guards shall be provided to prevent persons' hands or other parts of their body being injured by the rope or pulleys of hook blocks or bottom blocks in power-operated cranes or hoists if the blocks are used for loads of less than 5 tons.
- (39) Guards shall be provided if there is a danger that ropes will become displaced from pulleys, or quadrants.

*Rope anchorages*

- (40) Eye splices, sockets, and rope anchorages shall be capable of withstanding 90% of the guaranteed breaking strength of the rope or ropes to which they are attached.
- (41) Rope anchorages shall be readily accessible at all times.
- (42) There shall be at least 2 full turns of each rope, remaining on the drum or barrel when the hook or other lifting or hauling medium is fully lowered or unwound.

*Splicing*

- (43) Eye splices shall have at least 3 tucks with each whole strand of the rope, and 2 tucks with  $\frac{1}{2}$  of the wires cut out of each strand, made in each case, under and over against the lay of the rope.
- (44) The splice shall be tightly drawn and neatly made.
- (45) Thimbles shall be used if ropes are spliced to hooks, shackles, rings, swivels, pins, eyes, and analogous fittings.

*Periodic inspection of rope*

- (46) No person shall use any wire rope or any attachments of it unless the rope and the attachments of it have been subjected to close detailed examination at the intervals that are necessary or advisable to ensure that defective ropes or attachments are not used.
- (47) No steel wire rope shall be used if it is excessively worn, corroded, or otherwise defective, or if in any length equal to 8 diameters of the rope the number of visible broken wires exceeds 10% of the total number of wires in the rope.

*Identification and testing of steel wire rope*

- (48) No person shall use any steel wire rope unless the person holds a purchaser's docket or other document, issued to the person and signed by the person from whom he or she purchased or obtained the use of the rope, clearly and legibly setting out in the English language the length of rope to which the docket or document applies, the size, construction and lay of the rope, the maker's guaranteed minimum breaking tensile strength of the rope, the maker's identification number of the coil from which the rope was obtained, and the date of purchase or acquisition of the rope.
- (49) Every person using any steel wire rope shall when so required by an inspector immediately produce to the inspector, and allow the inspector to examine and copy, the docket or document required by subsection (48) to be held by the person for that rope.
- (50) Every person who uses or has in his or her possession for use any steel wire rope shall, if requested by the chief inspector so to do, produce to the chief inspector or to an inspector named in the request, at a reasonable place specified in the request and within a reasonable time not exceeding 4 weeks after the receipt of the request, a test certificate for the rope or of rope of which it formed a part, which certificate shall be in accordance with Australian Standard Specification No M4—1955, appendix K, 'Steel Wire Ropes for Winding and Hauling Purposes in Mines' of Standards Australia, and the person shall, if necessary for compliance with the request, cause the appropriate test to be made.
- (51) Unless the chief inspector directs the production of the original certificate, the production of a true copy of it, if bearing a statement signed by the maker or a vendor of the rope that it is a true copy, shall be a sufficient compliance with the request.
- (52) Any person who in any test certificate given for steel wire rope knowingly makes or signs any false statement, or who knowingly makes or signs a false statement that any document is a true copy of the certificate, commits a breach of this regulation.

**Fibre rope for use in connection with cranes, lifts, hoists, scaffolding, plant, gear, or building work, excavation work, or compressed air work****145***General*

- (1) All fibre rope and every part of it shall be of sound material, good construction, adequate strength, free from patent defects and be suitable and safe for the purpose for which it is intended.
- (2) Suitable packing shall be provided and used to prevent fibre rope coming in contact with sharp edges of loads, etc.
- (3) Fibre rope shall not be exposed to extremes of temperature either in or out of use.
- (4) Fibre ropes of circumference less than 1<sup>1</sup>/<sub>2</sub> inches shall not be used for load carrying purposes unless otherwise approved.
- (5) If fibre rope is held by hand under load, it shall be not less than 2 inches circumference.
- (6) Kinked ropes shall not be used.
- (7) Ropes shall be kept clean, stored under cover in a clean dry place, and be raised clear of the ground.
- (8) In no case shall the rope be in contact with ashes, clinker or coke.
- (9) Ropes shall be kept clear of acids and other deleterious chemicals and their fumes.
- (10) Ropes shall be examined each time before being used.
- (11) If a load is supported on more than 1 fall or single part of rope, the load shall be equally distributed by statically determinate automatic means between the various falls, singles or parts.

- (12) No rope shall be used for load-carrying purposes that has been subjected to a severe shock or that has been unduly stretched.
- (13) No rope sling shall be used if the included angle measured between any 2 legs exceeds 150°, or if the angle formed between any sling leg and the line of action of the pull exceeds 75°.
- (14) Rope slings before being used, and if repaired or altered, before being reused shall be subjected to a load equal to their safe working load and closely examined to ensure suitability for use or reuse as the case may be.
- (15) Fibre rope shall not be exposed to temperatures exceeding 150° Fahrenheit.
- (16) Fibre ropes that are excessively worn or have been adversely affected by weather or by water shall be discarded.

*Design, construction, use and safe working load*

- (17) All fibre rope shall comply with the provisions of Australian Standard Specifications No (E) L.507—1941, or No (E) L.508—1941, promulgated by Standards Australia, unless otherwise approved.
- (18) However—
  - (a) every fibre rope shall be classified numerically in conformity with table 145; and
  - (b) in the event of uncertainty or dispute the classification may be determined by the chief inspector; and
  - (c) no fibre rope shall be subjected to any greater load than that determined by multiplying the least ultimate tensile value of the rope by the fraction mentioned in subsections (21) and (22) relevant and appropriate to its classification and way of use.



- (19) For subsection (18) (c), the least ultimate tensile value of a rope that is in the best condition may be deemed equal to the minimum breaking load or strength of that rope prescribed by Australian Standard Specification No (E) L.507—1941, for sisal rope or No (E) L.508—1941, for Manila rope, whichever is relevant and appropriate, the specifications being those promulgated by Standards Australia.
- (20) For worn rope the ultimate tensile value shall be deemed to be  $\frac{1}{2}$  of that determined in accordance with subsection (18) (c).
- (21) Ropes within classification 1 of table 145.
- (22) Ropes within classification 2 of table 145.
- (23) Unless first approved by the chief inspector no fibre rope shall be used of other design or other material than that provided in Australian Standard Specifications mentioned in subsection (19).

**Table 145 Classification of fibre rope for purposes of design, construction and use**

classification number	classification of crane, hoist, lift, plant or scaffolding in connection with which the fibre rope is used	rope used for other purposes
1	classification No 1, 2 and 3	building work, excavation work, or compressed air work
2	classification No 4	

*Ratio of drum (barrel) or sheave diameter to rope diameter*

- (24) The diameter of any drum, barrel, roller, sheave or quadrant measured at the surface on which the rope operates shall be not less than 5 times the diameter of the rope concerned if hand-operated, or 10 times the rope diameter if power-operated.

*Guards*

- (25) Guards shall be provided to prevent ropes becoming displaced from sheaves, rollers or quadrants.

*Rope anchorages*

- (26) Each rope anchorage shall be capable of withstanding 75% of the ultimate tensile strength of the rope attached to it.
- (27) Rope anchorages shall be readily accessible at all times.
- (28) There shall be at least 2 full turns of each rope remaining on the drum or barrel when the hook or other lifting or hauling medium is fully lowered or unwound.

*Splicing*

- (29) Eye splices shall have at least 3 tucks with each whole strand of the rope, made under and over against the lay of the rope, and followed by effective dog-knotting.
- (30) The splice shall be tightly drawn and neatly made.
- (31) Thimbles shall be used if ropes are spliced to hooks, shackles, rings, swivels, pins, eyes or analogous media.

*Periodic inspection of rope*

- (32) No person shall use any fibre rope or any attachment of it unless the rope and the attachments have been subjected to close detailed examinations at the intervals that are necessary or advisable to ensure that defective ropes or attachments are not used.

## **Airlocks**

### **146**

Every airlock shall be designed and constructed in accordance with the provisions of the Australian Standard Rules for the Design, Construction, Inspection and Operation of Boilers and Unfired Pressure Vessels and their Appurtenances published by Standards Australia, as revised in 1942.

## **Bordeaux connections**

### **147**

Bordeaux connections for connecting wire rope to crane chain, and fittings used in a like way shall comply with the provisions of British Standard Specification No 461—1932, promulgated by the British Standards Institution, England, except as may be otherwise provided in this regulation.

## **Sockets for wire ropes**

### **148**

Sockets for wire rope and fittings used in a like way shall comply with the provisions of British Standard Specification No 463—1946, promulgated by the British Standards Institution, England, except as may be otherwise provided in this regulation.

## **Thimbles for wire and fibre rope**

### **149**

Thimbles for wire and fibre rope shall be of approved design and construction.

## **Steel eye bolts**

### **150**

- (1) Steel eye bolts and analogous fittings shall comply with the provisions of British Standard Specification No 529, parts 1 and 2, 1944, promulgated by the British Standards Institution, England, except as may be otherwise provided in this regulation.
- (2) The maximum load in the threaded part of an eye bolt shall not exceed that prescribed by section 126 (38) having due regard to the classification of the eye bolt.
- (3) Eye bolts without collars shall, unless otherwise approved, be used only for direct axial loading.

## **Mild steel rigging screws, and stretching screws and turnbuckles**

### **151**

- (1) Mild steel rigging screws, and stretching screws and turnbuckles and analogous fittings shall comply with the provision of British Standard Specification No 716—1937, promulgated by the British Standards Institution, England, except as may be otherwise provided in this regulation.
- (2) The maximum load in the threaded section of any tensile male component of these fittings shall not exceed that prescribed by section 126 (38) having due regard to classification.

## **Mild steel shackles**

### **152**

Mild steel shackles and analogous fittings shall comply with British Standard Specification No 825—1939, promulgated by the British Standards Institution, England, except as may be otherwise provided in this regulation.

## Rings, links alternative to rings, egg links and Intermediate links

### 153

Rings, links alternative to rings, egg links and intermediate links, and analogous fittings shall comply with the provisions of British Standard Specification No 781—1938, promulgated by the British Standards Institution, England, except as may be otherwise provided in this regulation.

## Handrails

### 154

- (1) Except if otherwise provided—
  - (a) handrails shall be fixed at a height of 3 feet above the working platforms or surfaces served, and shall be strongly supported at points not further apart than 8 feet; and
  - (b) handrails shall be of not less strength and rigidity than the following alternative members:
    - (i) if of timber—pine timber not less than 3 inches in depth by 2 inches in horizontal width; or
    - (ii) if of steel—steel water pipe of 1 inch diameter nominal bore, having a wall thickness not less than 0.144 of an inch; or
    - (iii) if of rolled mild steel—rolled mild steel angle section  $1\frac{3}{4}$  inches by  $1\frac{3}{4}$  inches by  $\frac{1}{4}$  of an inch.
- (2) Unless otherwise approved, handrail stanchions or standards shall be welded or bolted in place, with bolts each not less than  $\frac{3}{8}$  of an inch in diameter and having washers under heads and nuts.

- (3) Handrails shall be strongly secured to standards by—
- (a) steel U-strips not less than 1 inch in width and  $\frac{1}{16}$  of an inch in thickness, strongly spiked or screwed in place; or
  - (b) bolts as for standards; or
  - (c) approved cleats or approved lashings; or
  - (d) by adequate full-strength welding.

### **Rope clips**

#### **155**

Rope clips shall not be used unless—

- (a) they are of approved design and construction; and
- (b) they are used only for the purpose and in the way approved.

### **Gin blocks used with fibre rope**

#### **156**

##### *Frames*

- (1) The frame shall be either—
- (a) a malleable iron or steel casting, or other approved material; or
  - (b) a fabricated wrought steel frame constructed as follows:
    - (i) the vertical part of the frames shall be formed from flat rectangular mild steel bar with horizontal rope guards (also of flat rectangular mild steel bar) welded by an approved process to the vertical part of the frame; and
    - (ii) all sharp corners and edges shall be dressed to prevent the chafing of the rope.

*Clearances*

- (2) The openings in the frame shall be adequate to prevent contact with and chafing the rope.
- (3) The total clearance between the sheave and the frame shall not exceed  $\frac{1}{16}$  of an inch.
- (4) The clearance between the hole in the crosshead and shank of the hook, between the axle pin and the holes in the frame, between the axle pin and the hole in the sheave and between the side of the cotter pin and the frame shall not exceed  $\frac{1}{64}$  of an inch.

**Lift boxes****157***Materials*

- (1) All timber used in the construction of lift boxes shall comply with the provisions of 'Standard Grade for Scantlings' set out in the Australian Standard Grading Rules (Emergency Series) for Sawn and Hewn Structural Timbers, No (E) 054—1942, as amended in June, 1944.
- (2) Lift boxes for loads not exceeding 3 tons shall be made of oregon timber 2 inches thickness, or alternatively of hardwood  $1\frac{1}{2}$  inches thickness.
- (3) Every lift box shall be fitted with 2 carrying straps 3 inches by  $\frac{5}{8}$  of an inch mild steel each passing under the bottom and up both sides of the box.
- (4) These straps shall be secured to the timber with bolts  $\frac{1}{2}$  an inch diameter.
- (5) The end of each strap at the top of the box shall have a hole formed in it to accommodate the lifting tackle.

**Part 13** Precautions and measures to be taken for securing the safety of persons in connection with roofs sheathed with asbestos cement or other brittle material

Section 158

---

## **Part 13**                      **Precautions and measures to be taken for securing the safety of persons in connection with roofs sheathed with asbestos cement or other brittle material**

**158**

(1) In this section:

*large regulation sheets* means corrugated asbestos cement sheets of material not less than  $\frac{1}{4}$  of an inch in thickness, having corrugations  $1\frac{7}{8}$  inches and over in depth, the pitch of the corrugations being more than 3 inches but not more than  $5\frac{3}{4}$  inches measured centre to centre of adjacent crests or troughs.

*longitudinal wires* means the safety mesh wires parallel to the corrugations of the roof sheathing.

*roof* means the roof, or part of it, of any building or structure, except of a private dwelling house and its outhouses, the upper surface of which roof makes an angle of less than  $50^\circ$  with the horizontal.

*safety mesh* means a meshwork of steel wires of size and arrangement required by this section.

*small section sheets* means corrugated asbestos cement sheets of material not less than  $\frac{7}{32}$  of an inch in thickness, having corrugations less than  $1\frac{7}{8}$  inches in depth, the pitch of the corrugations being 3 inches or less measured centre to centre of adjacent crests or troughs.

*transverse wires* means the safety mesh wires at right angles to the corrugations of the roof sheathing.



- (2) No person shall place, lay or fix, or cause to be placed, laid or fixed, on any roof structure, or part of a roof structure, any roof sheathing of asbestos cement or other brittle material unless safety mesh has first been securely fixed in the way provided in this regulation over the area to be sheathed.
- (3) However, the chief inspector may, by written notice, exempt from this requirement any roof—
  - (a) if the chief inspector is satisfied that generally the roof construction is such that it would provide the same degree of safety as would any other roof on which safety mesh has been fixed; or
  - (b) in which the members immediately supporting corrugated asbestos cement sheathing are spaced—
    - (i) not more than 1 foot 6 inches apart measured centre to centre for small section sheets; or
    - (ii) not more than 2 feet apart measured centre to centre for large section sheets; or
  - (c) vertically below which a substantial and closely boarded floor or like structure is located at a distance not greater than 8 feet, measured from the highest part of the roof.
- (4) Corrugated asbestos cement sheathing for roofs shall be mature and free from cracks and defects liable to impair its strength.
- (5) The distance between purlins or other immediate supports for corrugated asbestos cement roof sheathing shall not when measured centre to centre exceed—
  - (a) 4 feet 1<sup>1</sup>/<sub>2</sub> inches for a large section sheet, measured in the direction of the corrugations; or

**Part 13**      Precautions and measures to be taken for securing the safety of persons in connection with roofs sheathed with asbestos cement or other brittle material

Section 158

---

- (b) 3 feet for small section sheets, measured as mentioned in paragraph (a); or
  - (c) the distance approved in writing by the chief inspector for sheets differing in section from those mentioned in paragraphs (a) and (b).
- (6) No person shall place, lay or fix asbestos cement sheets on any roof structure unless the person is wearing sandshoes or other approved footwear.
- (7) Safety mesh shall be constructed entirely of steel wire the ultimate tensile strength of which is not less than 35 tons per square inch.
- (8) The wire shall be zinc galvanised so that the weight of the zinc coat in ounces per square foot shall not be less than the value, appropriate to the tensile strength of the wire, as provided in British Standard Specification 443, 1939, table 2, for the testing of the zinc coating on galvanised wires, promulgated by the British Standards Institution, London, England, as amended in February, 1945.
- (9) Each mesh shall be rectangular in shape and shall not exceed 12 inches in length and 6 inches in width.
- (10) The wires forming each mesh shall be strongly secured, one to the other, at each corner of the mesh.
- (11) The diameter of the wire with which each type of safety mesh is formed shall be as provided in the table after subsection (13).
- (12) Safety mesh shall be fixed to purlins or other anchorages at the spacings set out in the table after subsection (13) in any 1 of the following ways:
- (a) if the purlins or other anchorages are of timber the longitudinal wires shall—

- (i) be bent down and fixed to the sides of the purlins or other anchorages with galvanised steel staples of the gauges, lengths and spacing as set out in table 158; or
    - (ii) be fixed to the tops of them with galvanised steel staples of the gauges, lengths and spacing as set out in table 158; or
  - (b) the longitudinal wires of the safety mesh shall be passed once completely around the purlin, or other anchorage, the tail of each wire being twisted twice tightly around the main part of the same wire; or
  - (c) the longitudinal wires of the safety mesh shall be secured to the purlins or other anchorages with 10 gauge (0.128 of an inch diameter) galvanised steel wire loops by passing the centre of the tying wire around the longitudinal wire at a point of intersection of a transverse wire, so that a transverse wire shall be between that point and the end of the longitudinal wire, passing both ends of the tying wire once completely around the purlin, or other anchorage, the 2 tails of the tying wire being then drawn in opposite directions over the 2 strands of the tying wire and twisted together with at least 3 complete turns.
- (13) All staples shall be driven in such way that a cross wire is between the end of the wire and the staple or the end of the wire is bent back and twisted twice around the same wire, so that individual wires cannot be drawn from the staple.

**Part 13** Precautions and measures to be taken for securing the safety of persons in connection with roofs sheathed with asbestos cement or other brittle material

Section 158

**Table 158**

diameter of wire in mesh inch	mesh dimensions inches	gauge of staple s.w.g.	fastening to side of purlin: length of staple inches	fastening to top of purlin: length of staple inches	spacing of staples or other fastenings inches
0.128	12 × 6	10	1 <sup>1</sup> / <sub>4</sub>	1 <sup>1</sup> / <sub>2</sub>	12
0.104	6 × 6	11	1	1 <sup>1</sup> / <sub>4</sub>	6
0.092	4 × 4	11	1	1 <sup>1</sup> / <sub>4</sub>	8, 4*
0.080	3 × 3	11	1	1 <sup>1</sup> / <sub>4</sub>	6

\* Pairs of wires at 12-inch centres, ie wires alternately at 8-inch and 4-inch centres.

- (14) Safety mesh shall be deemed not to conform to the requirements of this section unless a complete specification and the samples of mesh, as may be required, have been submitted to the chief inspector and approved by him or her.
- (15) Safety mesh shall be fixed immediately and closely under the roof sheathing, without other intervention, and so that it rests on each of the roof members; it shall be free from perceptible sag.
- (16) The longitudinal wires shall pass above and across all roof members that immediately support the roof sheathing.
- (17) All the transverse wires shall be located above the longitudinal wires.
- (18) If the longer sides of a mesh exceed 6 inches, the safety mesh shall be so disposed that the lesser sides are parallel to the corrugations.
- (19) If a break of continuity in the longitudinal wires occurs, the wires shall be effectively joined to preserve continuity.

- (20) In addition, the longitudinal wires at the adjoining or overlapping edges of adjacent lengths of safety mesh shall be strongly fastened together at intervals not greater than 3 feet.
- (21) Adjacent lengths of safety meshing shall not, when fixed, be more than 1 inch apart.
- (22) Without limiting subsections (1) to (21), the apertures resulting from junctions or connections of safety mesh shall not exceed those prescribed for the construction of the mesh, or be otherwise oriented.
- (23) No person shall carry out or cause to be carried out any roof sheathing work unless safety mesh has first been fully fixed as a margin around all positions where the work is to be carried out.
- (24) If not otherwise limited by the boundaries of the roof structure, or boundaries incidental to the application of this section, this margin shall be at least 20 feet in width.
- (25) Safety mesh shall not be used if it is likely to be affected by corrosive agencies but purlins or battens spaced as provided in subsection (3) (b) shall be used in its place.
- (26) Safety mesh or its fastenings or supports that has been reduced in strength by corrosion or other agency to less than 90% of the strength indicated by this section shall on reduction be renewed by the owner of the building, to comply with this section.
- (27) Safety mesh shall not be considered as affording support to the roof sheathing.
- (28) The owner of any building (other than a private dwelling house), or any structure, having any roof sheathing of asbestos cement or other brittle material, shall provide and fix on each individual slope, curve, or flat of roofing of it, the warning or danger notices in the positions, and way prescribed in this section.



- (38) They shall be so placed that they constitute plain and clearly visible warning to persons about to enter on the roofs.
- (39) Each notice shall be so placed and so oriented, that the arrows on them are directly above and point along the line of nails, screws, bolts, or other fastenings that secure the roof sheathing to its immediate supports.
- (40) Each notice shall be so placed and so oriented that it clearly indicates those lines that mark the positions and directions of uninterruptedly continuous supporting members of the roof sheathing.
- (41) No person shall fix a warning notice on a roof until the person has first ensured that there is an uninterruptedly continuous supporting member along each line of nails, screws, or other fastenings after which to be indicated by the notice, and if any such member is not uninterruptedly continuous the person shall cause it to be made so before fixing the notice.
- (42) If any supporting member of the sheathing of any roof is incapable of safely supporting a concentrated load of 300 pounds acting vertically downwards and so placed as to be of most adverse effect, no person shall fix a warning notice as previously prescribed.
- (43) Instead, danger notices shall be strongly fixed, as prescribed in this section for warning notices.
- (44) Danger notices shall bear the words—  
Danger  
Keep off this roof  
in heavy block lettering in red on a white background.
- (45) The word ‘Danger’ shall be at least 1<sup>3</sup>/<sub>4</sub> inches in height and shall be heavily underlined in red.
- (46) The remainder of the lettering shall be at least 1<sup>3</sup>/<sub>8</sub> inches in height.

**Part 13**      Precautions and measures to be taken for securing the safety of persons in connection with roofs sheathed with asbestos cement or other brittle material

Section 158

---

- (47) The danger notices shall not be less than 12 inches square and shall in all other respects conform with the requirements of this regulation for warning notices.



## Part 16 Miscellaneous and penalties

### General penalty

#### 164

- (1) When any matter or thing is by this regulation required, directed or forbidden to be done, or if any authority is given by this regulation to any person to require, direct or forbid any matter or thing to be done, and the matter or thing so required or directed to be done remains undone, or the matter or thing so forbidden to be done is done, in every such case every person offending against the requirement, direction or prohibition, commits an offence against this regulation.
- (2) Any person guilty of a breach of this regulation shall, if no other penalty is expressly provided in this regulation for the breach, be liable to a penalty not exceeding \$100.

---

## **Schedule 3      Method of treatment of silica paint for the purpose of ascertaining the percentage of free silica present**

- 1 take 10g of paint and extract with successive portions of a suitable solvent until the residue is free from vehicle
- 2 take 0.5g of dry residue and boil for 5 minutes with 50mL of 20%, acetic acid containing 5.0g of ammonium acetate, then cool, centrifuge, decant off the supernatant liquid, and wash the residue with 50mL of 20% acetic acid
- 3 treat the residue with 50mL of 1:2 hydrochloric acid, boil, cool, centrifuge, decant, and wash with 50mL of 1:2 hydrochloric acid
- 4 treat the residue with 25mL of concentrated sulphuric acid containing 5g of sodium sulphate, then heat to fuming, cool, centrifuge, decant, and wash with 25mL of concentrated sulphuric acid, decant and wash with 25mL of water
- 5 boil the residue for 5 minutes with 50mL of 10% sodium carbonate, cool, centrifuge, decant, and wash with 50mL of 1:10 hydrochloric acid
- 6 transfer residue to a platinum dish, evaporate to dryness, ignite, and weigh (residue A)
- 7 treat the residue with 5mL of hydrofluoric acid, containing 0.5mL of concentrated sulphuric acid, then heat on water bath for 1 hour, evaporate to dryness over flame, ignite and weigh (residue B)
- 8 free silica equals residue A minus residue B

---

## **Schedule 4      Processes to which s 73 (1) (o) applies**

- 1 dry grinding of surfaces of metal, stone, concrete, or similar materials by means of a wheel or discs driven by mechanical power
- 2 cutting, dressing, or carving of stone, concrete or similar material by means of a portable tool driven by mechanical power
- 3 chipping, or scaling of painted or corroded metal surfaces or wire brushing of the surfaces by mechanical power
- 4 cutting out or cutting off of cold rivets or bolts from any structure or part of a structure
- 5 welding or cutting of metals by means of an electrical, oxyacetylene or similar process

## **Schedule 5      Method of treatment of a lead compound for the purpose of determining the percentage of dry compound of lead**

- 1 the material is to be treated with suitable solvents to remove the oil, varnish, and other media, and the residue to be dried at 100° C and thoroughly mixed
- 2 a weighed quantity of this extracted, dried and mixed material is to be continuously shaken for 1 hour, at the common temperature, with 1 000 times its weight of an aqueous solution of hydrochloric acid containing 0.25% by weight of hydrogen chloride
- 3 this solution is then to be allowed to stand for 1 hour and then filtered
- 4 the lead salt contained in the clear filtrate is then to be precipitated as lead sulphide and weighed as lead sulphate

## Schedule 7

**Table 7.1 Decompression—stoppages after exceeding ordinary time limits**

(see s 99 (21) to (23))

depth		pressure	time from leaving surface to beginning of ascent	stoppages at different depths in minutes								total time for ascent
ft	fathoms	lb/in <sup>2</sup>		80ft	70ft	60ft	50ft	40ft	30ft	20ft	10ft	minutes
66	11	29	over 3h	...	...	...	...	...	...	10	30	42
72	12	32	2 to 3h	...	...	...	...	...	...	10	30	42
			over 3h	...	...	...	...	...	...	20	30	52
78	13	34 <sup>1/2</sup>	1 <sup>1/2</sup> to 2 <sup>1/2</sup> h	...	...	...	...	...	...	20	30	52
			over 2 <sup>1/2</sup> h	...	...	...	...	...	...	30	30	62

Schedule 7

depth		pressure	time from leaving surface to beginning of ascent	stoppages at different depths in minutes								total time for ascent
ft	fathoms	lb/in <sup>2</sup>		80ft	70ft	60ft	50ft	40ft	30ft	20ft	10ft	minutes
84	14	37	1 <sup>1</sup> / <sub>4</sub> to 1 <sup>1</sup> / <sub>2</sub> h	...	...	...	...	...	...	10	25	37
			1 <sup>1</sup> / <sub>2</sub> to 1 <sup>3</sup> / <sub>4</sub> h	...	...	...	...	...	...	10	30	42
			1 <sup>3</sup> / <sub>4</sub> to 2h	...	...	...	...	...	...	15	30	47
			2 to 2 <sup>1</sup> / <sub>2</sub> h	...	...	...	...	...	20	30	52	
			2 <sup>1</sup> / <sub>4</sub> to 2 <sup>1</sup> / <sub>2</sub> h	...	...	...	...	2	23	30	57	
			2 <sup>1</sup> / <sub>2</sub> to 2 <sup>3</sup> / <sub>4</sub> h	...	...	...	...	3	27	30	62	
			2 <sup>3</sup> / <sub>4</sub> to 3h	...	...	...	...	5	30	30	67	
			over 3h	...	...	...	...	10	30	35	77	

Schedule 7

depth		pressure	time from leaving surface to beginning of ascent	stoppages at different depths in minutes								total time for ascent
ft	fathoms	lb/in <sup>2</sup>		80ft	70ft	60ft	50ft	40ft	30ft	20ft	10ft	minutes
90	15	40	1h to 1h 12min	...	...	...	...	...	5	10	20	37
			1h 12min to 1hr 20min	...	...	...	...	...	5	15	20	42
			1h 20min to 1 <sup>1</sup> / <sub>2</sub> h	...	...	...	...	...	5	15	25	47
			1 <sup>1</sup> / <sub>2</sub> h to 1h 44min	...	...	...	...	...	5	20	25	52
			1h 44min to 2h	...	...	...	...	...	5	25	25	57
			2h to 2h 14min	...	...	...	...	...	5	25	30	62
			2h 14min to 2 <sup>1</sup> / <sub>2</sub> h	...	...	...	...	...	5	30	30	67
			2 <sup>1</sup> / <sub>2</sub> h to 2h 44min	...	...	...	...	...	10	30	30	72
			2h 44min to 3h 14min	...	...	...	...	...	20	30	30	82
			over 3h 14min	...	...	...	...	...	20	35	35	92

Schedule 7

depth		pressure	time from leaving surface to beginning of ascent	stoppages at different depths in minutes								total time for ascent
ft	fathoms	lb/in <sup>2</sup>		80ft	70ft	60ft	50ft	40ft	30ft	20ft	10ft	minutes
96	16	42 <sup>1</sup> / <sub>2</sub>	55min to 1h 12min	...	...	...	...	...	5	10	25	42
			1h 12min to 1 <sup>1</sup> / <sub>2</sub> h	...	...	...	...	...	5	15	30	52
			1 <sup>1</sup> / <sub>2</sub> h to 1h 54mins	...	...	...	...	...	5	25	30	62
			1h 54min to 2h 18min	...	...	...	...	...	10	30	30	72
			2h 18min to 2 <sup>1</sup> / <sub>2</sub> h	...	...	...	...	...	10	30	35	77
			2 <sup>1</sup> / <sub>2</sub> h to 2h 54min	...	...	...	...	...	20	30	35	87
			over 2h 54min	...	...	...	...	...	30	35	35	102
108	18	48	40 to 50min	...	...	...	...	...	8	10	20	41
			50min to 1h	...	...	...	...	...	10	15	20	48
			1h to 1h 18min	...	...	...	...	...	10	20	25	58



Schedule 7

depth		pressure	time from leaving surface to beginning of ascent	stoppages at different depths in minutes								total time for ascent
ft	fathoms	lb/in <sup>2</sup>		80ft	70ft	60ft	50ft	40ft	30ft	20ft	10ft	minutes
			1h 18min to 1h 44min	...	...	...	...	...	15	20	35	73
			1h 44min to 2h	...	...	...	...	5	15	25	35	83
			2h to 2h 18min	...	...	...	...	5	20	30	35	92
			2h 18min to 2h 34min	...	...	...	...	10	25	30	35	102
			2h 34min to 2h 50min	...	...	...	...	15	25	30	40	112
			over 2h 50min	...	...	...	...	15	30	35	40	122
120	20	53 <sup>1</sup> / <sub>2</sub>	35 to 50min	...	...	...	...	...	10	15	20	47
			50min to 1h	...	...	...	...	5	10	15	25	57
			1h to 1h 22min	...	...	...	...	5	15	25	25	72
			1h 22min to 1h 44min	...	...	...	...	5	20	30	30	87

Schedule 7

depth		pressure	time from leaving surface to beginning of ascent	stoppages at different depths in minutes								total time for ascent
ft	fathoms	lb/in <sup>2</sup>		80ft	70ft	60ft	50ft	40ft	30ft	20ft	10ft	minutes
			1h 44min to 2h	...	...	...	...	10	20	30	35	97
			2h to 2h 22min	...	...	...	...	15	25	35	35	112
			2h 22min to 2h 44min	...	...	...	...	20	30	35	40	127
			over 2h 44min	...	...	...	...	30	35	35	40	142
132	22	59	30min to 38min	...	...	...	...	...	5	15	20	43
			38min to <sup>3</sup> / <sub>4</sub> h	...	...	...	...	5	10	15	20	53
			<sup>3</sup> / <sub>4</sub> h to 1h	...	...	...	...	5	15	20	25	68
			1 to 1 <sup>1</sup> / <sub>4</sub> h	...	...	...	...	10	20	25	25	83
			1 <sup>1</sup> / <sub>4</sub> h to 1 <sup>1</sup> / <sub>2</sub> h	...	...	...	5	10	20	30	30	98
				...	...	...	5	15	20	35	35	113

Schedule 7

depth		pressure	time from leaving surface to beginning of ascent	stoppages at different depths in minutes								total time for ascent
ft	fathoms	lb/in <sup>2</sup>		80ft	70ft	60ft	50ft	40ft	30ft	20ft	10ft	minutes
			1 <sup>1/2</sup> h to 1 <sup>3/4</sup> h	...	...	...	10	20	25	35	35	128
			1 <sup>3/4</sup> h to 2h	...	...	...	15	25	30	35	35	143
			2 to 2 <sup>1/4</sup> h	...	...	...	15	30	35	40	40	163
			over 2 <sup>1/4</sup> h									
144	24	64 <sup>1/2</sup>	25 to 32min	...	...	...	...	3	7	12	18	43
			32min to 39min	...	...	...	...	5	9	14	22	53
			39min to <sup>3</sup> / <sub>4</sub> h	...	...	...	3	5	10	15	25	61
			<sup>3</sup> / <sub>4</sub> h to 1h	...	...	...	5	5	15	20	30	78
			1h to 1 <sup>1/4</sup> h	...	...	...	5	10	20	25	30	93
				...	...	...	10	10	20	30	35	108

Schedule 7

depth		pressure	time from leaving surface to beginning of ascent	stoppages at different depths in minutes								total time for ascent
ft	fathoms	lb/in <sup>2</sup>		80ft	70ft	60ft	50ft	40ft	30ft	20ft	10ft	minutes
			1 <sup>1</sup> / <sub>4</sub> h to 1 <sup>1</sup> / <sub>2</sub> h	...	...	...	15	15	20	35	35	123
			1 <sup>1</sup> / <sub>2</sub> h to 1 <sup>3</sup> / <sub>4</sub> h	...	...	...	20	20	25	35	35	138
			1 <sup>3</sup> / <sub>4</sub> h to 2h	...	...	...	20	25	30	35	40	153
			2 to 2 <sup>1</sup> / <sub>4</sub> h	...	...	...	25	25	35	40	40	168
			2 <sup>1</sup> / <sub>4</sub> to 2 <sup>1</sup> / <sub>2</sub> h	...	...	...	30	30	35	40	40	178
			over 2 <sup>1</sup> / <sub>2</sub> h									
156	26	70	20 to 24min	...	...	...	2	4	8	9	12	38
			24 to 30min	...	...	...	2	4	10	12	17	48
			30 to 35min	...	...	...	3	5	10	15	20	56
			35 to 45min	...	...	...	5	6	12	20	25	71

Schedule 7

depth		pressure	time from leaving surface to beginning of ascent	stoppages at different depths in minutes								total time for ascent
ft	fathoms	lb/in <sup>2</sup>		80ft	70ft	60ft	50ft	40ft	30ft	20ft	10ft	minutes
			45 to 55min	...	...	...	5	8	15	25	30	86
			55 to 60min	...	...	...	7	10	15	30	30	95
			1h to 1h 9min	...	...	...	10	10	20	30	35	108
			1h 9min to 1h 18min	...	...	...	10	15	25	35	35	123
			1h 18min to 1h 27min	...	...	...	15	15	30	35	40	138
			1h 27min to 1h 37min	...	...	5	15	20	30	40	40	153
			1h 37min to 1h 47min	...	...	10	20	20	35	40	40	168
			1h 47min to 1h 56min	...	...	15	20	30	35	40	40	183
			over 1h 56min	...	...	20	25	30	35	40	40	193
168	28	75	16 to 23min	...	...	...	2	4	8	11	15	43
			23 to 30min	...	...	...	3	5	10	15	20	56

Schedule 7

depth		pressure	time from leaving surface to beginning of ascent	stoppages at different depths in minutes								total time for ascent
ft	fathoms	lb/in <sup>2</sup>		80ft	70ft	60ft	50ft	40ft	30ft	20ft	10ft	minutes
			30 to 40min	...	...	...	4	7	12	20	25	71
			40 to 50min	...	...	...	6	10	12	25	30	86
			50 to 60min	...	...	3	10	10	15	30	30	101
			1h to 1 <sup>1</sup> / <sub>4</sub> h	...	...	5	10	15	20	35	35	123
			1 <sup>1</sup> / <sub>4</sub> to 1 <sup>1</sup> / <sub>2</sub> h	...	...	10	15	20	25	35	35	143
			1 <sup>1</sup> / <sub>2</sub> h to 1h 40min	...	2	13	15	25	30	35	40	163
			1h 40min to 1h 55min	...	3	17	20	25	35	40	40	183
			over 1h 55min	...	5	25	25	30	35	40	40	203
180*	30	80 <sup>1</sup> / <sub>2</sub>	14 to 20min	...	...	...	2	3	7	10	15	41
			20 to 30min	...	...	2	2	3	10	15	25	60

Schedule 7

depth		pressure	time from leaving surface to beginning of ascent	stoppages at different depths in minutes								total time for ascent
ft	fathoms	lb/in <sup>2</sup>		80ft	70ft	60ft	50ft	40ft	30ft	20ft	10ft	minutes
			30 to 40min	...	...	2	3	6	14	20	30	77
			40 to 50min	...	...	2	6	8	15	25	35	94
			50 to 60min	...	3	3	7	10	20	35	35	111
			1h to 1h 11min	...	3	5	10	15	25	35	35	131
			1h 11min to 1h 23min	...	3	5	15	20	30	35	40	151
			1h 23min to 1h 34min	...	8	10	20	25	30	35	40	171
			1h 34min to 1h 46min	...	8	20	25	30	30	35	40	191
			over 1h 46min	...	15	25	30	30	35	40	40	218
192*	32	86	13 to 20min	...	...	...	3	3	7	15	15	46
			20 to 30min	...	...	3	3	5	10	15	25	64

Schedule 7

depth		pressure	time from leaving surface to beginning of ascent	stoppages at different depths in minutes								total time for ascent
ft	fathoms	lb/in <sup>2</sup>		80ft	70ft	60ft	50ft	40ft	30ft	20ft	10ft	minutes
			30 to 40min	...	...	5	6	8	10	20	30	82
			40 to 50min	...	...	5	8	9	15	25	35	100
			50 to 60min	...	3	5	10	12	20	30	35	118
			1h to 1 <sup>1</sup> / <sub>4</sub> h	...	5	10	15	15	25	35	35	143
			1 <sup>1</sup> / <sub>4</sub> h to 1h 26min	...	10	15	15	20	25	35	40	163
			1h 26min to 1h 37min	...	15	15	20	25	30	35	40	183
			1h 37min to 1h 48min	...	20	20	25	25	30	40	40	203
			over 1h 48min	5	20	25	30	30	35	40	40	228
204*	34	91 <sup>1</sup> / <sub>2</sub>	12 to 20min	...	...	3	3	5	7	10	20	51
			20 to 30min	...	3	3	3	5	10	20	20	67



Schedule 7

depth		pressure	time from leaving surface to beginning of ascent	stoppages at different depths in minutes								total time for ascent
ft	fathoms	lb/in <sup>2</sup>		80ft	70ft	60ft	50ft	40ft	30ft	20ft	10ft	minutes
			30 to 40min	...	3	3	4	8	15	25	25	86
			40 to 50min	...	3	4	5	15	20	25	30	105
			50 to 60min	3	3	5	10	15	20	30	35	124
			1h to 1h 10min	3	3	7	12	20	25	35	35	143
			1h 10min to 1h 20min	3	4	8	15	25	30	35	40	163
			1h 20min to 1 <sup>1</sup> / <sub>2</sub> h	3	7	10	20	25	35	40	40	183
			1 <sup>1</sup> / <sub>2</sub> h to 1h 40min	5	10	15	25	30	35	40	40	203
			1h 40min to 1h 50min	10	15	20	30	30	35	40	40	223
			over 1h 50min	15	20	25	30	30	35	40	40	238

\* Handworked pumps are unsuitable at this depth.

Schedule 7

**Table 7.2 Decompression—ordinary time limits, stoppages and air supply**

(see s 99 (23) to (26))

depth		pressure	time from leaving surface to beginning of ascent	stoppages in minutes at different depths						total time for ascent	number of cylinders needed*	revolutions of pump	number of workers per shift on pumps
ft	fathoms	lb/in <sup>2</sup>		60ft	50ft	40ft	30ft	20ft	10ft	minutes		per minute*	
0-33	0-5 <sup>1</sup> / <sub>2</sub>	0-15	no limit	...	...	...	...	...	...	0 to 1	1	15 to 30†	2
33-42	5 <sup>1</sup> / <sub>2</sub> -7	15-18 <sup>1</sup> / <sub>2</sub>	up to 3hr	...	...	...	...	...	...	1 to 1 <sup>1</sup> / <sub>2</sub>	2	15 to 20	2
			over 3h	...	...	...	...	...	5	6			
42-48	7-8	18 <sup>1</sup> / <sub>2</sub> -21	up to 1h	...	...	...	...	...	...	1 <sup>1</sup> / <sub>2</sub>	2	20	2
			1 to 3h	...	...	...	...	...	5	6 <sup>1</sup> / <sub>2</sub>			

depth		pressure	time from leaving surface to beginning of ascent	stoppages in minutes at different depths						total time for ascent	number of cylinders needed*	revolutions of pump	number of workers per shift on pumps
ft	fathoms	lb/in <sup>2</sup>		60ft	50ft	40ft	30ft	20ft	10ft	minutes		per minute*	
			over 3h	...	...	...	...	...	10	11 <sup>1</sup> / <sub>2</sub>			
48-54	8-9	21-24	up to 1/2h	...	...	...	...	...	...	2	2	20	2
			1/2 to 1 <sup>1</sup> / <sub>2</sub> h	...	...	...	...	...	5	7			
			1 <sup>1</sup> / <sub>2</sub> to 3h	...	...	...	...	...	10	12			
			over 3h	...	...	...	...	...	20	22			
54-60	9-10	24-26 <sup>1</sup> / <sub>2</sub>	up to 20min	...	...	...	...	...	...	2	2	25	4
			20 to 45min	...	...	...	...	...	5	7			
			3/4 to 1 <sup>1</sup> / <sub>2</sub> h	...	...	...	...	...	10	12			

Schedule 7

depth		pressure	time from leaving surface to beginning of ascent	stoppages in minutes at different depths						total time for ascent	number of cylinders needed*	revolutions of pump	number of workers per shift on pumps
ft	fathoms	lb/in <sup>2</sup>		60ft	50ft	40ft	30ft	20ft	10ft	minutes		per minute*	
			1 1/2 to 2h	...	...	...	...	4	10	16			
			2 to 3h	...	...	...	...	5	15	22			
			over 3h	...	...	...	...	10	20	32			
60-66	10-11	26 <sup>1/2</sup> -29 <sup>1/2</sup>	up to 15min	...	...	...	...	...	...	2	2	25	4
			15 to 30min	...	...	...	...	...	5	7			
			30 to 48min	...	...	...	...	2	8	12			
			48 to 60min	...	...	...	...	3	10	15			
			1 to 1 1/2h	...	...	...	...	4	13	19			

depth		pressure	time from leaving surface to beginning of ascent	stoppages in minutes at different depths						total time for ascent	number of cylinders needed*	revolutions of pump	number of workers per shift on pumps
ft	fathoms	lb/in <sup>2</sup>		60ft	50ft	40ft	30ft	20ft	10ft	minutes		per minute*	
			1½ to 2h	...	...	...	...	5	15	22			
			2 to 2½h	...	...	...	...	5	20	27			
			2½ to 3h	...	...	...	...	10	20	32			
66-72	11-12	29½-32	up to 15min	...	...	...	...	...	2	4	2	25	4
			15 to 25min	...	...	...	...	2	4	8			
			25 to 30min	...	...	...	...	3	5	10			
			30 to 45min	...	...	...	...	4	9	15			
			¾h to 1h	...	...	...	...	5	12	19			

Schedule 7

depth		pressure	time from leaving surface to beginning of ascent	stoppages in minutes at different depths						total time for ascent	number of cylinders needed*	revolutions of pump	number of workers per shift on pumps
ft	fathoms	lb/in <sup>2</sup>		60ft	50ft	40ft	30ft	20ft	10ft	minutes		per minute*	
			1 to 1½h	...	...	...	...	8	16	26			
			1½ to 2h	...	...	...	...	10	20	32			
72-78	12-13	32-34½	up to 10min	...	...	...	...	...	3	5	2	25	4
			10 to 20min	...	...	...	...	...	5	7			
			20 to 30min	...	...	...	...	3	8	13			
			30 to 38min	...	...	...	...	4	12	18			
			38 to 45min	...	...	...	...	5	15	22			
			¾ to 1h	...	...	...	...	8	16	26			

depth		pressure	time from leaving surface to beginning of ascent	stoppages in minutes at different depths						total time for ascent	number of cylinders needed*	revolutions of pump	number of workers per shift on pumps
ft	fathoms	lb/in <sup>2</sup>		60ft	50ft	40ft	30ft	20ft	10ft	minutes		per minute*	
			1 to 1 <sup>1</sup> / <sub>4</sub> h	...	...	...	...	9	18	29			
			1 <sup>1</sup> / <sub>4</sub> to 1 <sup>1</sup> / <sub>2</sub> h	...	...	...	...	10	20	32			
78-84	13-14	34 <sup>1</sup> / <sub>2</sub> -37	up to 10min	...	...	...	...	...	3	5	2	30†	6
			10 to 20min	...	...	...	...	...	5	7			
			20 to 30min	...	...	...	...	3	8	13			
			30 to 40min	...	...	...	...	4	13	19			
			40 to 45min	...	...	...	...	5	15	22			
			45 to 55min	...	...	...	...	8	16	26			

Schedule 7

depth		pressure	time from leaving surface to beginning of ascent	stoppages in minutes at different depths						total time for ascent	number of cylinders needed*	revolutions of pump	number of workers per shift on pumps
ft	fathoms	lb/in <sup>2</sup>		60ft	50ft	40ft	30ft	20ft	10ft	minutes		per minute*	
			55 to 65min	...	...	...	...	9	18	29			
			65 to 75min	...	...	...	...	10	20	32			
84-90	14-15	37-40	up to 10min	...	...	...	...	1	3	6	2	30†	
			10 to 20min	...	...	...	...	3	5	10			
			20 to 30min	...	...	...	...	4	10	16			
			30 to 40min	...	...	...	...	5	15	22			
			40 to 50min	...	...	...	2	7	15	26			
			50 to 60min	...	...	...	3	10	15	30			



depth		pressure	time from leaving surface to beginning of ascent	stoppages in minutes at different depths						total time for ascent	number of cylinders needed*	revolutions of pump	number of workers per shift on pumps
ft	fathoms	lb/in <sup>2</sup>		60ft	50ft	40ft	30ft	20ft	10ft	minutes		per minute*	
90-96	15-16	40-42 <sup>1</sup> / <sub>2</sub>	up to 10min	...	...	...	...	1	3	7	2	30†	6
			10 to 20min	...	...	...	...	3	5	11			
			20 to 30min	...	...	...	...	5	11	18			
			30 to 35min	...	...	...	...	5	15	22			
			35 to 45min	...	...	...	2	8	15	27			
			45 to 55min	...	...	...	5	10	15	32			
98-108	16-18	42 <sup>1</sup> / <sub>2</sub> -48	up to 5min	...	...	...	...	...	3	6	4	20	1
			5 to 10min	...	...	...	...	...	5	8			

Schedule 7

depth		pressure	time from leaving surface to beginning of ascent	stoppages in minutes at different depths						total time for ascent	number of cylinders needed*	revolutions of pump	number of workers per shift on pumps
ft	fathoms	lb/in <sup>2</sup>		60ft	50ft	40ft	30ft	20ft	10ft	minutes		per minute*	
			10 to 15min	...	...	...	...	3	5	11			
			15 to 20min	...	...	...	...	4	8	15			
			20 to 25min	...	...	...	1	5	10	19			
			25 to 30min	...	...	...	3	7	10	23			
			30 to 35min	...	...	...	4	8	15	28			
			35 to 40min	...	...	...	5	10	15	33			
108-120	18-20	48-53 <sup>1</sup> / <sub>2</sub>	up to 5min	...	...	...	...	...	4	7	4	20	12
			5 to 10min	...	...	...	...	2	6	11			

depth		pressure	time from leaving surface to beginning of ascent	stoppages in minutes at different depths						total time for ascent	number of cylinders needed*	revolutions of pump	number of workers per shift on pumps
ft	fathoms	lb/in <sup>2</sup>		60ft	50ft	40ft	30ft	20ft	10ft	minutes		per minute*	
			10 to 15min	...	...	...	2	3	7	15			
			15 to 20min	...	...	...	3	5	8	19			
			20 to 25min	...	...	...	5	5	10	23			
			25 to 30min	...	...	...	5	8	12	28			
			30 to 35min	...	...	...	5	10	15	33			
120-132	20-22	53 <sup>1</sup> /259	up to 5min	...	...	...	...	...	5	8	4	25	12
			5 to 10min	...	...	...	...	3	7	13			
			10 to 15min	...	...	...	2	5	7	17			

Schedule 7

depth		pressure	time from leaving surface to beginning of ascent	stoppages in minutes at different depths						total time for ascent	number of cylinders needed*	revolutions of pump	number of workers per shift on pumps
ft	fathoms	lb/in <sup>2</sup>		60ft	50ft	40ft	30ft	20ft	10ft	minutes		per minute*	
			15 to 20min	...	...	...	3	7	10	23			
			20 to 25min	...	...	...	4	8	13	28			
			25 to 30min	...	...	...	5	10	15	33			
132-144	22-24	59-64 <sup>1/2</sup>	up to 6min	...	...	...	...	2	5	10	4	25	12
			6 to 12min	...	...	...	3	5	5	16			
			12 to 16min	...	...	...	4	7	7	21			
			16 to 20min	...	...	1	4	8	10	26			
			20 to 25min	...	...	2	5	10	12	32			

depth		pressure	time from leaving surface to beginning of ascent	stoppages in minutes at different depths						total time for ascent	number of cylinders needed*	revolutions of pump	number of workers per shift on pumps
ft	fathoms	lb/in <sup>2</sup>		60ft	50ft	40ft	30ft	20ft	10ft	minutes		per minute*	
144-156	24-26	64 <sup>1</sup> / <sub>2</sub> -70	up to 5min	...	...	...	...	2	5	10	4	25	12
			5 to 10min	...	...	...	3	5	5	16			
			10 to 15min	...	...	1	4	7	8	23			
			15 to 20min	...	2	3	5	8	10	31			
156-168	26-28	70-75	up to 5min	...	...	...	...	2	5	10	4	30 <sup>†</sup>	12
			5 to 10min	...	...	2	3	5	5	18			
			10 to 13min	...	1	2	4	6	8	24			
			13 to 16min	...	2	3	5	7	10	30			

Schedule 7

depth		pressure	time from leaving surface to beginning of ascent	stoppages in minutes at different depths						total time for ascent	number of cylinders needed*	revolutions of pump	number of workers per shift on pumps
ft	fathoms	lb/in <sup>2</sup>		60ft	50ft	40ft	30ft	20ft	10ft	minutes		per minute*	
168-180	28-30	75-80 <sup>1</sup> / <sub>2</sub>	up to 5min	...	...	...	...	3	5	11	4	30 <sup>†</sup>	12
			5 to 9min	...	...	2	3	5	5	18			
			9 to 12min	...	...	3	4	6	8	24			
			12 to 14min	...	2	3	5	7	10	30			
180-192 <sup>‡</sup>	30-32	80 <sup>1</sup> / <sub>2</sub> -86	up to 5min	...	...	...	1	3	5	12	...	...	...
			5 to 10min	...	1	2	3	6	8	23			
			10 to 13min	...	2	3	5	7	10	30			

Schedule 7

depth		pressure	time from leaving surface to beginning of ascent	stoppages in minutes at different depths						total time for ascent	number of cylinders needed*	revolutions of pump	number of workers per shift on pumps
ft	fathoms	lb/in <sup>2</sup>		60ft	50ft	40ft	30ft	20ft	10ft	minutes		per minute*	
192-204‡	32-34	86-91½	up to 7min	...	2	2	3	5	5	20	...	...	...
			7 to 12min	2	2	3	5	7	10	32	...	...	...

\* These figures are based on a double-acting pump with cylinder diameter 4 inches, stroke 7½ inches, working at 80% efficiency.

† If 30 revolutions per minute cannot be maintained, another cylinder may be used instead.

‡ Handworked pumps are unsuitable at this depth.

Schedule 7

**Table 7.3 Decompression times for different periods of exposure to working pressure**

(see s 100 (31) and s 101 (31))

gauge in the working chamber lb/in <sup>2</sup>	reduced at rate of 5 lb/in <sup>2</sup> /min		further uniform reduction to zero (gauge pressure)																							
	to gauge pressure of lb/in <sup>2</sup>	time in min	for periods of 6h or more		for periods of 4h		for periods of 3h		for periods of 2 <sup>1</sup> / <sub>4</sub> h		for periods of 2h		for periods of 1 <sup>3</sup> / <sub>4</sub> h		for periods of 1 <sup>1</sup> / <sub>2</sub> h		for periods of 1 <sup>1</sup> / <sub>4</sub> h		for periods of 1h		for periods of 3/4h		for periods of 1/2h			
			time in min	min/lb	time in min	min/lb	time in min	min/lb	time in min	min/lb	time in min	min/lb	time in min	min/lb	time in min	min/lb	time in min	min/lb	time in min	min/lb	time in min	min/lb	time in min	min/lb	time in min	min/lb
18 or 19	2	3	4	2.0	3	1.5	3	1.5	2	1.0	2	1.0	2	1.0	1	0.5	1	0.5	1	0.5	1	0.5	1	0.5	1	0.5
20 or 21	3	4	12	4.0	7	2.3	6	2.0	5	1.7	4	1.3	3	1.0	3	1.0	2	0.7	2	0.7	1	0.3	1	0.3		
22 or 23	4	4	23	5.7	15	3.7	12	3.0	9	2.2	8	2.0	6	1.5	6	1.5	4	1.0	3	0.7	2	0.5	1	0.2		
24 or 25	5	4	34	6.8	25	5.0	19	3.8	14	2.8	12	2.4	10	2.0	9	1.8	7	1.4	5	1.0	4	0.8	2	0.4		
26 or 27	6	4	45	7.5	36	6.0	27	4.5	20	3.3	17	2.8	14	2.3	13	2.2	10	1.7	8	1.3	6	1.0	3	0.5		
28 or 29	7	4	55	7.9	46	6.6	35	5.0	26	3.7	22	3.1	19	2.7	17	2.4	13	1.9	11	1.6	8	1.1	5	0.7		



Schedule 7

gauge in the working chamber lb/in <sup>2</sup>	reduced at rate of 5 lb/in <sup>2</sup> /min		further uniform reduction to zero (gauge pressure)																					
	to gauge pressure of lb/in <sup>2</sup>	time in min	for periods of 6h or more		for periods of 4h		for periods of 3h		for periods of 2 <sup>1</sup> / <sub>4</sub> h		for periods of 2h		for periods of 1 <sup>3</sup> / <sub>4</sub> h		for periods of 1 <sup>1</sup> / <sub>2</sub> h		for periods of 1 <sup>1</sup> / <sub>4</sub> h		for periods of 1h		for periods of 3/4h		for periods of 1/2h	
			time in min	min/lb	time in min	min/lb	time in min	min/lb	time in min	min/lb	time in min	min/lb	time in min	min/lb	time in min	min/lb	time in min	min/lb	time in min	min/lb	time in min	min/lb	time in min	min/lb
30 or 31	8	5	64	8.0	54	6.8	43	5.4	32	4.0	27	3.4	24	3.0	21	2.6	17	2.1	14	1.7	10	1.2	6	0.8
32 or 33	9	5	73	8.1	63	7.0	52	5.8	39	4.3	34	3.8	30	3.3	26	2.9	21	2.3	17	1.9	12	1.3	8	0.9
34 or 35	10	5	82	8.2	72	7.2	61	6.1	46	4.6	41	4.1	36	3.6	31	3.1	26	2.6	21	2.1	15	1.5	10	1.0
36 or 37	11	5	90	8.2	82	7.4	70	6.4	54	4.9	48	4.4	42	3.8	37	3.4	31	2.8	25	2.3	19	1.7	12	1.1
38 or 39	12	5	99	8.2	91	7.6	79	6.6	63	5.2	56	4.7	49	4.1	43	3.6	36	3.0	29	2.4	22	1.8	14	1.2

Schedule 7

gauge in the working chamber lb/in <sup>2</sup>	reduced at rate of 5 lb/in <sup>2</sup> /min		further uniform reduction to zero (gauge pressure)																							
	to gauge pressure of lb/in <sup>2</sup>	time in min	for periods of 6h or more		for periods of 4h		for periods of 3h		for periods of 2 <sup>1</sup> / <sub>4</sub> h		for periods of 2h		for periods of 1 <sup>3</sup> / <sub>4</sub> h		for periods of 1 <sup>1</sup> / <sub>2</sub> h		for periods of 1 <sup>1</sup> / <sub>4</sub> h		for periods of 1h		for periods of 3/4h		for periods of 1/2h			
			time in min	min/lb	time in min	min/lb	time in min	min/lb	time in min	min/lb	time in min	min/lb	time in min	min/lb	time in min	min/lb	time in min	min/lb	time in min	min/lb	time in min	min/lb	time in min	min/lb	time in min	min/lb
40 to 41	13	6	106	8.2	98	7.6	87	6.7	71	5.5	64	4.9	56	4.3	48	3.7	40	3.1	32	2.5	25	1.9	16	1.2		
42 or 43	14	6	...	...	106	7.6	94	6.7	80	5.7	73	5.2	64	4.6	55	3.9	45	3.2	37	2.6	29	2.1	18	1.3		
44 or 45	15	6	...	...	114	7.6	102	6.8	89	5.9	81	5.4	72	4.8	62	4.1	50	3.3	42	2.8	33	2.2	21	1.4		
46 or 47	16	6	...	...	121	7.6	110	6.9	97	6.1	90	5.6	80	5.0	69	4.3	56	3.5	47	2.9	37	2.3	24	1.5		
48 or 49	17	6	...	...	129	7.6	117	6.9	105	6.2	98	5.8	88	5.2	76	4.5	63	3.7	52	3.1	41	2.4	28	1.6		
50 or 51	18	7	...	...	136	7.6	124	6.9	112	6.2	106	5.9	95	5.3	83	4.6	70	3.9	57	3.2	45	2.5	30	1.7		
52 or 53	19	7	...	...	...	...	131	6.9	119	6.3	114	6.0	103	5.4	92	4.8	78	4.1	62	3.3	49	2.6	34	1.8		
54 or 55	20	7	...	...	...	...	138	6.9	127	6.3	120	6.0	110	5.5	100	5.0	87	4.3	68	3.4	54	2.7	38	1.9		

Schedule 7

gauge in the working chamber lb/in <sup>2</sup>	reduced at rate of 5 lb/in <sup>2</sup> /min		further uniform reduction to zero (gauge pressure)																							
	to gauge pressure of lb/in <sup>2</sup>	time in min	for periods of 6h or more		for periods of 4h		for periods of 3h		for periods of 2 <sup>1</sup> / <sub>4</sub> h		for periods of 2h		for periods of 1 <sup>3</sup> / <sub>4</sub> h		for periods of 1 <sup>1</sup> / <sub>2</sub> h		for periods of 1 <sup>1</sup> / <sub>4</sub> h		for periods of 1h		for periods of 3/4h		for periods of 1/2h			
			time in min	min/lb	time in min	min/lb	time in min	min/lb	time in min	min/lb	time in min	min/lb	time in min	min/lb	time in min	min/lb	time in min	min/lb	time in min	min/lb	time in min	min/lb	time in min	min/lb	time in min	min/lb
56 or 57	21	7	...	...	...	...	...	...	134	6.4	128	6.1	118	5.6	109	5.2	96	4.6	75	3.6	58	2.8	43	2.0		
58 or 59	22	7	...	...	...	...	...	...	140	6.4	135	6.1	126	5.7	117	5.3	104	4.7	83	3.8	63	2.9	47	2.1		
60	23	7	...	...	...	...	...	...	146	6.4	141	6.1	134	5.8	125	5.4	112	4.9	91	4.0	69	3.0	51	2.2		

*Note* 'Periods' referred to in column headings are periods of exposure to working pressure, and should not be confused with working periods at the face.

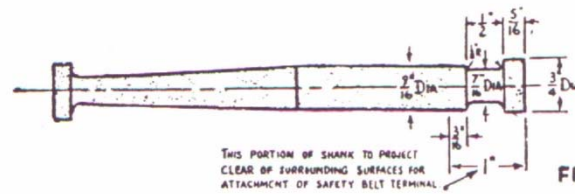

FIGURE 1.

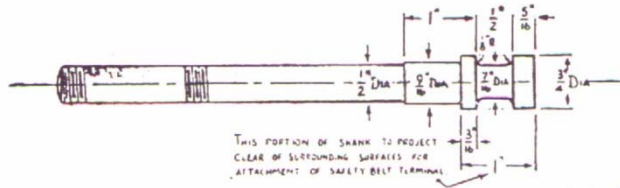

FIGURE 2.

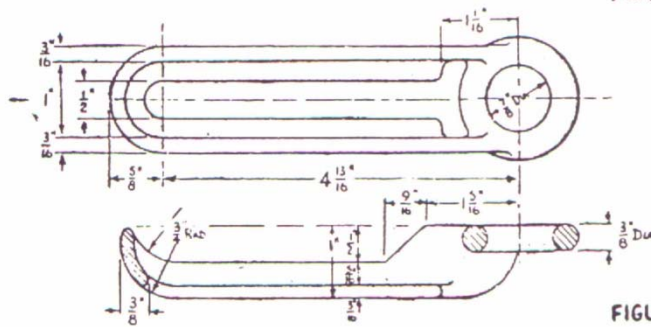
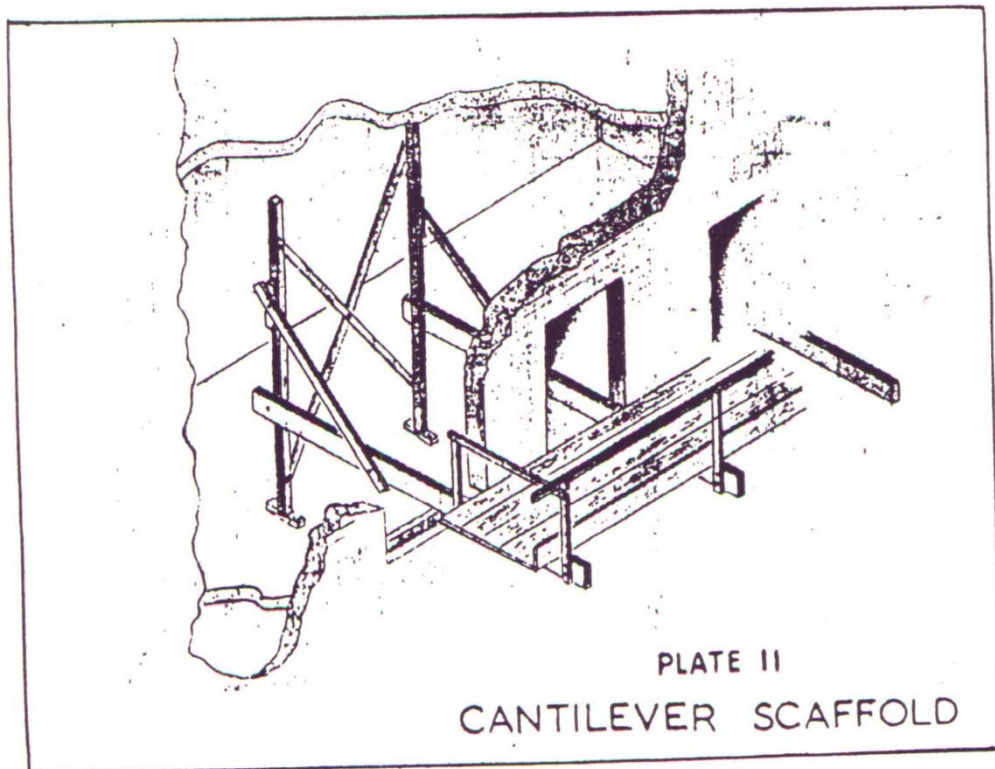
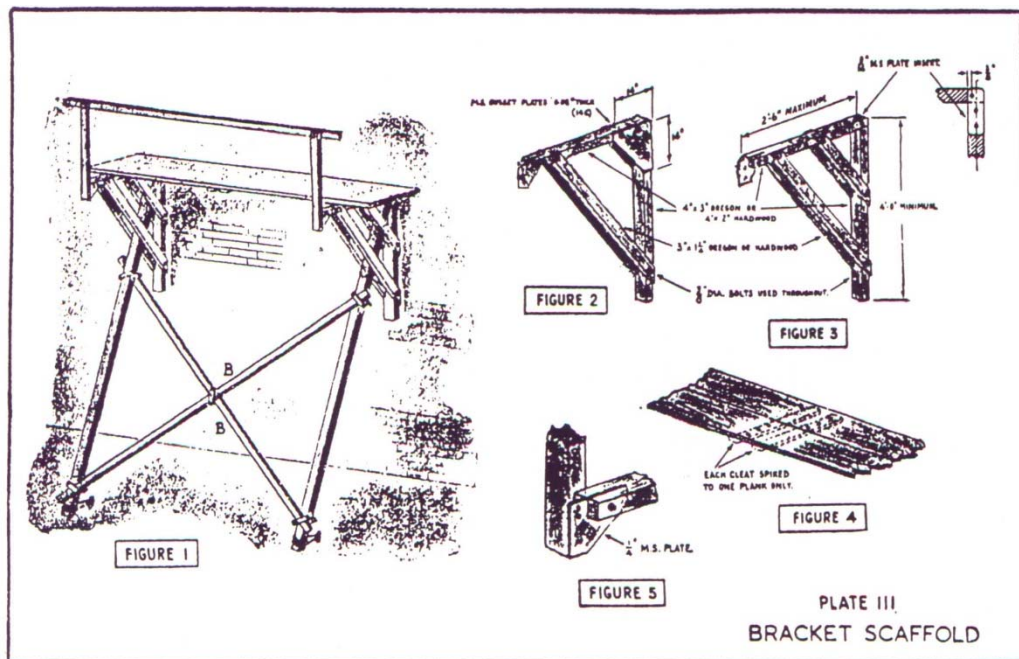

FIGURE 3.

PLATE I  
ANCHORS AND TERMINALS  
FOR SAFETY BELTS.





---

## Schedule 8      **Medical standards and examination report for compressed air workers**

The medical standards required for workers in compressed air are as follows:

- (a) age and physique—
  - (i) the worker shall be well-developed and healthy but not above the average weight/height ratio; and
  - (ii) the worker shall be intelligent, active and have good sight and hearing; and
  - (ii) there shall be no marked development of adipose tissue nor evidence of premature senility.
- (b) respiratory system—
  - (i) there shall be no disease of the respiratory system; or
  - (ii) there shall be no disease of the middle ear or blockage of the Eustachian tubes; or
  - (ii) there shall be no disease of the the pharynx or frontal sinuses.
- (c) circulatory system—
  - (i) there shall be no evidence of disease of the heart or the blood vessels; and
  - (ii) the arteries shall not be thickened or the blood pressure above a figure normal for the age.

- (d) nervous system—
  - (i) there shall be no disease of the nervous system or special senses; and
  - (ii) there shall be no evidence of neurasthenia, neurosis or psychosis.
- (e) renal system—
  - (i) there shall be no evidence of disease of the kidneys or bladder; and
  - (ii) there shall be no evidence of either albuminuria or glucosuria.



**Examination report for compressed air workers**

Name of applicant.....age.....

General physical condition.....

.....

Respiratory system:

    lungs.....

    nose, ears, throat.....

    sinuses.....

Circulatory system:

    blood pressure.....

    heart.....

Nervous system.....

Renal system.....

    Urine: { albu min.....  
          { glu cose.....

Result of chest X-ray examination.....

.....

I certify that I have carefully examined.....  
and consider that he/she is fit/not fit to work under compressed air conditions.

(In the event of an unfavourable opinion, please state reasons.)

.....

Signature of medical officer

.....  
Dated:

---

## Schedule 9      Symptoms and treatment of compressed air illness

### *Symptoms of compressed air illness*

- 1 The symptoms of compressed air illness are due to the liberation of bubbles of nitrogen in the blood or tissues and usually occur after the return of a person to normal air pressure.
- 2 The time of onset is generally a few minutes after decompression has been completed, but may be delayed as much as 4 hours, occasionally a case may occur during decompression.

### *Forms of compressed air illness*

- 3 The different forms that compressed air illness may assume are very numerous, and any illness or unusual symptoms after compression should be investigated at once with a view to eliminating compressed air illness.
- 4 If any doubt exists, it is wise to place the person concerned under a small pressure to ascertain if there is any alleviation of the symptoms.
- 5 The following forms of compressed air illness are most commonly encountered:
  - (1) 'Bends' are the most common form of compressed air illness. These are painful and sometimes acute manifestations of the illness that affect 1 or more limbs. They are not dangerous unless both arms or legs are effected, that may indicate a bubble in the spinal cord. Bends are most likely to occur in muscles that have been the hardest worked. The pain begins gradually, but may rapidly assume a very painful climax which, unless relieved by recompression, may be sufficiently severe to make the person cry out. Any symptom of a 'bend' should be treated by recompression at the earliest possible moment. The longer recompression is delayed the more difficult will be the cure.

- 
- (2) Severe pains in the chest or abdomen. The pain in the chest may be accompanied by short, quick, gasping breathing, and the pain in the abdomen may lead to vomiting.
  - (3) Paralysis of the legs and arms. This is a very serious symptom, and unless relieved may lead to permanent loss of use of the limbs.
  - (4) Other forms are faintness or unconsciousness, jerky movements of the eye or loss of sight, deafness, swelling of the body, loss of speech. These forms are less common.

*Symptoms to be reported*

- 6 Any attack of 'bends', giddiness, vomiting or difficulty in breathing, disease of the heart, lungs, kidneys, genital organs, a chill, or any other disease that may come on a compressed air worker during or subsequent to work may have the most serious consequences to the worker's health.
- 7 Therefore, immediately on noticing the indisposition, the worker must report it to the medical officer or to a medical orderly, or failing either, to the contractor or a responsible representative of the contractor.

*Treatment of compressed air illness*

- 8 The cure for compressed air illness is immediate and adequate recompression, which causes diminution in the size and final disappearance of the bubble of gas that produced the symptom.

## Dictionary

(see s 2)

*Note 1* The Legislation Act contains definitions and other provisions relevant to this regulation.

*Note 2* For example, the Legislation Act, dict, pt 1, defines the following terms:

- document
- person.

*Note 3* Terms used in this regulation have the same meaning that they have in the *Scaffolding and Lifts Act 1912* (see Legislation Act, s 148). For example, the following terms are defined in the *Scaffolding and Lifts Act 1912*, dict:

- crane
- dogger
- gear
- inspector
- lift
- plant.

***analogous*** means radically analogous in relation to prime characteristics.

***approved*** means approved in writing by the chief inspector.

***axial stress*** means one produced by a force or load acting parallel to and concentrically with the longitudinal neutral axis of the member concerned, and is the initial stress so produced, before any redistribution that may accompany resultant elastic deformation of the member.

***bearing pressure***, in relation to a pin or shaft in a plain bearing, means bearing pressure calculated as for a plane rectangular area of length equal to the length of the bearing, and of width equal to the diameter of the bearing.

***birdcage scaffolding***—see section 85.

***cantilever scaffolding***—see section 85.

**conveyor**, for part 4 (Lifts)—see section 16.

**dead loads** means all loads of which the principal effects remain constant during operation or manipulation of the crane, lift, hoist, scaffolding, plant or gear concerned.

**designed** means effectively and correctly designed for its purpose in complete accordance with this regulation or, if provision is not included in this regulation, effectively and correctly designed for its purpose in an approved way.

**drawings** means permanent, fully detailed and fully dimensioned and annotated engineering drawings, clear, distinct, and to a commonly used scale, which are sufficiently complete for engineering workshop use to enable faithful manufacture of all items depicted.

**dynamically irreversible** means incapable of being set or kept in motion by energy applied at or to the power output member or part of any mechanism, linkage or device.

**dynamically reversible** means capable of being set or kept in motion by energy applied at or to the power output member or part of any mechanism, linkage or device.

**explosive-powered tool**, for part 9A (Explosive-powered tools—safety measures)—see section 118A.

**fixed end** means for purposes of stress determination, a fixed end or fixed connection so designed that it effectively maintains and preserves the tangent to the elastic curve of the end of the member concerned in its original direction and position, irrespective of applied loading.

**forged steel** means hot forged from steel conforming to Australian Standard Specification No E17—(1944 T.) General Locomotive Forgings of K quality, and Australian Standard Specification No B63—1938 *Carbon Steel Forgings (Primarily for Cranes and Hoists)*.

**free end** means for purposes of stress determination, a free end not specifically secured in a way that will effectively prevent its translation.

**heavy duty scaffolding**—see section 85.

**high tensile structural steel** means steel conforming to British Standard Specification No 548—1934, High Tensile Structural Steel for Bridges etc and General Building Construction, or British Standard Specification No 968—1941, *High Tensile (Fusion Welding Quality) Steel for Bridges, etc, and General Building Construction* promulgated by Standards Australia.

**hinged end** means for purposes of stress determination, a hinged end or hinged connection not specifically and effectively designed to transmit major restraining or other moments.

**in commission** means in commission but not necessarily active.

**independent pole scaffolding**—see section 85.

**light duty scaffolding**—see section 85.

**light swinging stage**—see section 85.

**limiting** means—

- (a) a maximum such that if it were increased; or
- (b) a minimum such that if it were decreased;

the increase or decrease would occasion contravention of the Act or this regulation, or in any way prejudice the safe working of the crane, lift, hoist, scaffolding or plant concerned.

**live loads** means all loads of which the principal effects vary during operation or manipulation of the crane, lift, hoist, scaffolding, plant or gear concerned, and include the working load and all loads due to inertia, momentum, braking and wind.

**mild steel** means—

- (a) except in relation to bolts or rivets—mild steel conforming to Australian Standard Specification No A.1—1940 *Rolled Steel Sections for Structural Purposes*; and
- (b) in relation to bolts or rivets—a mild steel approved by the chief inspector as being suitable for its purpose.

**projectile**, for part 9A (Explosive-powered tools—safety measures)—see section 118A.

**qualified operator**, for part 9A (Explosive-powered tools—safety measures)—see section 118A.

**roller** means a wheel or cylinder that is either without an axle, or in which an axle or equivalent device is employed principally for purposes of alignment and location as distinct from the transmission of loads or forces.

**run**—see section 85.

**S.A.A. Wiring Rules** means Australian Standard Rules for the electrical equipment of buildings, structures and premises, published by the Standards Australia, known as the S.A.A. Wiring Rules. (First issued June, 1931, revised December, 1934, revised January, 1940. Reprinted including corrigenda of February, 1940, February, 1943, and March, 1944. Amendment 3, 1945. All redated 1945. Amendment 4, January, 1946, redated 1946.).

**safety gear**, for part 4 (Lifts)—see section 16.

**safe working load** (or **working load**) means the greatest burden that may be imposed without contravening any provision of this regulation in or on the lifting or lowering instrument with which any crane, lift or hoist is provided for lifting or lowering, or on any platform of any scaffold, but does not include wind loads or any increase consequential to section 125 or the weight of the lifting hook, yoke, kibble, box, cage, vessel or other medium by which the load is raised or lowered, or the weight of the platform or framework of any scaffold.

***second-hand*** means evidencing previous usage that might reasonably be expected or anticipated to have resulted in wear or abrasion, distortion, fatigue, misalignment, cold working, strain hardening, overheating, corrosion, or other damage or deterioration, affecting the item concerned in whole or in part, and, in relation to any material, second-hand means not plainly self evidently new.

***section*** means actual section before any deformation that may follow or accompany application of stress and, unless otherwise stated, all sections must lie in planes normal to the longitudinal axes of the members concerned.

***service lift***, for part 4 (Lifts)—see section 16.

***single pole scaffolding***—see section 85.

***static counterbalance weights*** includes all counterbalance weights that do not move relatively to the crane, hoist, lift, scaffolding, plant or gear concerned or to its supporting structure.

***strength*** means computed strength except in relation to the strengths of materials or ropes, and unless the chief inspector specifically approves otherwise.

***stress*** means stress measured in tons per square inch, after including all increases prescribed by this regulation.

***suspended scaffolding***—see section 85.

***toe board***—see section 85.

***tool***, for part 9A (Explosive-powered tools—safety measures)—see section 118A.

***transverse stress*** means the longitudinal tensile or compressive fibre stress resulting at the skin of a member from forces that cause flexure, but not include the axial stress.

***under power*** means energised by any agency other than manual or gravitational.



***use***, an explosive-powered tool, for part 9A (Explosive-powered tools—safety measures)—see section 118A (3).

***work***, for part 9A (Explosive-powered tools—safety measures)—see section 118A.

***working load***—see *safe working load*.

## Endnotes

1 About the endnotes

---

## Endnotes

### 1 About the endnotes

Amending and modifying laws are annotated in the legislation history and the amendment history. Current modifications are not included in the republished law but are set out in the endnotes.

Not all editorial amendments made under the *Legislation Act 2001*, part 11.3 are annotated in the amendment history. Full details of any amendments can be obtained from the Parliamentary Counsel's Office.

Uncommenced amending laws and expiries are listed in the legislation history and the amendment history. These details are underlined. Uncommenced provisions and amendments are not included in the republished law but are set out in the last endnote.

If all the provisions of the law have been renumbered, a table of renumbered provisions gives details of previous and current numbering.

The endnotes also include a table of earlier republications.

### 2 Abbreviation key

am = amended	ord = ordinance
amdt = amendment	orig = original
ch = chapter	par = paragraph/subparagraph
def = definition	pres = present
dict = dictionary	prev = previous
disallowed = disallowed by the Legislative Assembly	(prev...) = previously
div = division	pt = part
exp = expires/expired	r = rule/subrule
Gaz = gazette	renum = renumbered
hdg = heading	reloc = relocated
IA = Interpretation Act 1967	R[X] = Republication No
ins = inserted/added	RI = reissue
LA = Legislation Act 2001	s = section/subsection
LR = legislation register	sch = schedule
LRA = Legislation (Republication) Act 1996	sdiv = subdivision
mod = modified/modification	sub = substituted
o = order	SL = Subordinate Law
om = omitted/repealed	<u>underlining</u> = whole or part not commenced or to be expired

### 3 Legislation history

This regulation was originally a NSW regulation—the *Regulations made under the Scaffolding and Lifts Act 1912* (NSW).

The *Scaffolding and Lifts Act 1912* (NSW) and this regulation were applied, in a modified form, as ACT laws by the *Scaffolding and Lifts Act 1957* (now repealed).

This regulation was renamed by the *Scaffolding and Lifts Regulations Amendment SL 1999 No 19* and later under the *Legislation Act 2001*.

Under the *Interpretation Act 1967* (repealed), s 65 all former NSW Acts in force in the ACT immediately before 10 November 1999 (including the *Scaffolding and Lifts Act 1912*) became, for all purposes, laws made by the ACT Legislative Assembly.

Under the *Scaffolding and Lifts Act 1912*, s 28 (now expired) the *Scaffolding and Lifts Regulation 1950* became, on 29 March 2001, for all purposes, a regulation made under that Act. This completed the process of making the regulation fully into an ACT law.

Before 11 May 1989, regulations commenced on their notification day unless otherwise stated (see *Interpretation Act 1967* s 50).

Before 11 May 1989, ordinances commenced on their notification day unless otherwise stated (see *Seat of Government (Administration) Act 1910* (Cwlth), s 12).

#### NSW legislation

##### **Scaffolding and Lifts Regulation 1950**

notified 25 May 1950 (NSW Gaz 1950 No 86)

commenced 1 June 1950 (s 1 (1))

as amended by

##### **Amendments of regulations made under the Scaffolding and Lifts Act 1912**

notified 1 September 1950 (NSW Gaz 1950 No 141)

commenced 1 September 1950

##### **Amendments of regulations made under the Scaffolding and Lifts Act 1912**

notified 3 November 1950 (NSW Gaz 1950 No 168)

commenced 3 November 1950

##### **Amendments of regulations made under the Scaffolding and Lifts Act 1912**

notified 6 March 1953 (NSW Gaz 1953 No 44)

## Endnotes

3 Legislation history

---

commenced 6 March 1953

### **Amendments of regulations made under the Scaffolding and Lifts Act 1912**

notified 3 December 1954 (NSW Gaz 1954 No 197)  
commenced 3 December 1954

### **Amendments of regulations made under the Scaffolding and Lifts Act 1912**

notified 5 August 1955 (NSW Gaz 1955 No 76)  
commenced 5 August 1955

### **Amendments of regulations made under the Scaffolding and Lifts Act 1912**

notified 9 March 1956 (NSW Gaz 1956 No 24)  
commenced 9 March 1956

### **Amendments of regulations made under the Scaffolding and Lifts Act 1912**

notified 22 June 1956 (NSW Gaz 1956 No 69)  
commenced 22 June 1956

### **Amendments of regulations made under the Scaffolding and Lifts Act 1912**

notified 19 October 1956 (NSW Gaz 1956 No 113)  
commenced 19 October 1956

### **Amendments of regulations made under the Scaffolding and Lifts Act 1912**

notified 1 March 1957 (NSW Gaz 1957 No 29)  
commenced 1 March 1957

## **Commonwealth legislation**

### **Scaffolding and Lifts Act 1957 No 8 sch pt 2 (as am by ord 1968 No 5; ord 1974 No 26; ord 1976 No 7; ord 1977 No 28; ord 1981 No 15; ord 1982 No 15; ord 1982 No 68; ord 1983 No 34)**

notified 19 September 1957 (Cwlth Gaz 1957 No 51)  
commenced 19 September 1957

### **Scaffolding and Lifts Ordinance 1968 No 5**

notified 21 March 1968 (Cwlth Gaz 1968 No 26)

commenced 21 March 1968

*Note* This ordinance only amends the Scaffolding and Lifts Act 1957 No 8.

**Scaffolding and Lifts Ordinance 1974 No 26**

notified 30 July 1974 (Cwlth Gaz 1974 No 62)

commenced 30 July 1974

*Note* This ordinance only amends the Scaffolding and Lifts Act 1957 No 8.

**Scaffolding and Lifts Ordinance 1976 No 7**

notified 24 February 1976 (Cwlth Gaz 1976 No S38)

commenced 24 February 1976

*Note* This ordinance only amends the Scaffolding and Lifts Act 1957 No 8.

**Scaffolding and Lifts (Amendment) Ordinance 1977 No 28**

notified 1 July 1977 (Cwlth Gaz 1977 No S124)

commenced 1 July 1977

*Note* This ordinance only amends the Scaffolding and Lifts Act 1957 No 8.

**Scaffolding and Lifts (Amendment) Ordinance 1981 No 15**

notified 30 June 1981 (Cwlth Gaz 1981 No S128)

commenced 30 June 1981

*Note* This ordinance only amends the Scaffolding and Lifts Act 1957 No 8.

**Scaffolding and Lifts (Amendment) Ordinance 1982 No 15**

notified 7 May 1982 (Cwlth Gaz 1982 No S93)

commenced 7 May 1982

*Note* This ordinance only amends the Scaffolding and Lifts Act 1957 No 8.

**Scaffolding and Lifts (Amendment) Ordinance (No 2) 1982 No 68**

notified 18 August 1982 (Cwlth Gaz 1982 No S174)

commenced 18 August 1982

*Note* This ordinance only amends the Scaffolding and Lifts Act 1957 No 8.

**Scaffolding and Lifts (Amendment) Ordinance 1983 No 34**

notified 29 September 1983 (Cwlth Gaz 1983 No S226)

## Endnotes

3 Legislation history

---

commenced 1 October 1983 (s 2)

*Note* This ordinance only amends the Scaffolding and Lifts Act 1957 No 8.

### **Regulations under the Scaffolding and Lifts Act 1912 (NSW) in their application to the Territory (Amendment) SL 1986 No 9**

notified 31 July 1986 (Cwlth Gaz 1986 No S375)

commenced 31 July 1986

### **Self-Government (Consequential Amendments) Ordinance 1989 No 38 sch 2**

notified 10 May 1989 (Cwlth Gaz 1989 No S160)

s 1, s 2 commenced 10 May 1989 (s 2 (1))

sch 2 commenced 11 May 1989 (s 2 (2) and see Cwlth Gaz 1989 No S164)

## **Legislation after becoming Territory enactment**

### **Scaffolding and Lifts Regulations Amendment SL 1999 No 19**

notified 30 September 1999 (Gaz 1999 No S57)

commenced 30 September 1999 (s 1)

### **Occupational Health and Safety Legislation Regulations Amendment SL 2000 No 47 pt 3**

notified 30 November 2000 (Gaz 2000 No 48)

commenced 30 November 2000 (s 1)

### **Statute Law Amendment Act 2001 No 11 sch 3**

notified 29 March 2001 (Gaz 2001 No 13)

commenced 29 March 2001 (s 2)

### **Legislation (Consequential Amendments) Act 2001 No 44 pt 359**

notified 26 July 2001 (Gaz 2001 No 30)

s 1, s 2 commenced 26 July 2001 (IA s 10B)

pt 359 commenced 12 September 2001 (s 2 and see Gaz 2001 No S65)

**Statute Law Amendment Act 2007 A2007-3 sch 3 pt 3.92**

notified LR 22 March 2007

s 1, s 2 taken to have commenced 1 July 2006 (LA s 75 (2))

sch 3 pt 3.92 commenced 12 April 2007 (s 2 (1))

**4 Amendment history****Name of regulation**

s 1 am regs gazetted 9 March 1956; regs gazetted 22 June 1956  
om Act 1957 No 8 sch pt 2 (as am ord 1977 No 28 s 5)  
ins 1999 No 19 sch  
am R2 LA

**Dictionary**

s 2 om Act 1957 No 8 sch pt 2 (as am ord 1977 No 28 s 4)  
ins A2007-3 amdt 3.471

**Notes**

s 3 defs reloc to dict A2007-3 amdt 3.470  
sub A2007-3 amdt 3.471  
def **chief inspector** ins Act 1957 No 8 sch pt 2  
om A2007-3 amdt 3.469  
def **inspector** ins Act 1957 No 8 sch pt 2  
om A2007-3 amdt 3.469  
def **the Act** sub Act 1957 No 8 sch pt 2; Act 2001 No 11  
amdt 3.257  
om Act 2001 No 44 amdt 1.3879  
def **the Explosives Act 1905** ins Act 1957 No 8 sch pt 2  
om 1999 No 19 sch

s 8 sub regs gazetted 1 September 1950  
om Act 1957 No 8 sch pt 2

s 9 om regs gazetted 1 September 1950

s 10 sub regs gazetted 1 September 1950  
om Act 1957 No 8 sch pt 2

s 11 sub Act 1957 No 8 sch pt 2

s 12 om Act 1957 No 8 sch pt 2

pt 3 hdg om Act 1957 No 8 sch pt 2

## Endnotes

### 4 Amendment history

---

s 15	om Act 1957 No 8 sch pt 2
<b>Interpretation</b>	
div 4.1 hdg	ins R2 LA
<b>Design, construction and erection of lifts</b>	
div 4.2 hdg	(prev pt 4 div A hdg) renum R2 LA
s 17	am Act 1957 No 8 sch pt 2; regs renum R2 LA
s 18	ss renum R2 LA
s 22	ss renum R2 LA
s 23	ss renum R2 LA
s 24	ss renum R2 LA
s 25	sub regs gazetted 3 December 1954 ss renum R2 LA
s 27	ss renum R2 LA
s 28	ss renum R2 LA
s 29	ss renum R2 LA; ss renum R3 LA
s 31	ss renum R2 LA
s 32	ss renum R2 LA
s 33	ss renum R2 LA
s 35	am Act 1957 No 8 sch pt 2; Act 2001 No 11 amdt 3.258
s 39	ss renum R2 LA
s 40	ss renum R2 LA



---

s 41	ss renum R2 LA
s 46	ss renum R2 LA
s 51	ss renum R2 LA
s 56	ss renum R2 LA
s 61	ss renum R2 LA
s 62	ss renum R2 LA
s 63	ss renum R2 LA
<b>Maintenance of lifts</b>	
div 4.3 hdg	(prev pt 4 div B hdg) renum R2 LA
s 67	pars renum R2 LA
<b>Use of lifts</b>	
div 4.4 hdg	(prev pt 4 div C hdg) renum R2 LA
s 68	am 2000 No 47 s 11; ss etc renum R2 LA
s 69	am Act 1957 No 8 sch pt 2
s 70	am 2000 No 47 s 12
s 72A	ins regs gazetted 22 June 1956 sub Act 1957 No 8 sch pt 2 (as am ord 1974 No 26 s 2; ord 1977 No 28 s 5) am Act 1957 No 8 sch pt 2 (as am ord 1981 No 15 s 2; ord 1982 No 68 s 2) om Act 1957 No 8 sch pt 2 (as am ord 1983 No 34 s 5)
<b>General</b>	
div 5.1 hdg	(prev pt 5 div A hdg) renum R2 LA
s 73	am Act 1957 No 8 sch pt 2 (as am ord 1976 No 7 s 2); ss etc renum R2 LA

---

## Endnotes

### 4 Amendment history

---

- s 75 ss renum R2 LA
- s 76 om regs gazetted 22 June 1956
- Construction, erecting, adding to, altering, repairing, finishing, painting and cleaning buildings and structures**  
div 5.2 hdg (prev pt 5 div B hdg) renum R2 LA
- s 78 ss renum R2 LA
- s 79 ss renum R2 LA
- s 80 ss renum R2 LA
- s 81 ss renum R2 LA
- s 82 am Act 1957 No 8 sch pt 2; Act 2001 No 11 amdt 3.259; ss etc renum R2 LA
- s 83 am Act 1957 No 8 sch pt 2; ss etc renum R2 LA
- Demolition of buildings and structures**  
div 5.3 hdg (prev pt 5 div C hdg) renum R2 LA
- s 84 am regs gazetted 22 June 1956; 1999 No 19 sch; ss etc renum R2 LA
- s 86 ss etc renum R2 LA
- s 87 am regs gazetted 3 December 1954; ss etc renum R2 LA
- s 88 ss renum R2 LA
- s 89 ss etc renum R2 LA
- s 90 ss renum R2 LA
- s 91 ss etc renum R2 LA

---

s 92	ss etc renum R2 LA
s 93	ss etc renum R2 LA
s 94	ss renum R2 LA
<b>General</b>	
div 7.1 hdg	(prev pt 7 div A hdg) renum R2 LA
s 95	am regs gazetted 3 December 1954; regs gazetted 22 June 1956; ss renum R2 LA
<b>Cofferdams and caissons</b>	
div 7.2 hdg	(prev pt 7 div B hdg) renum R2 LA
<b>Trenches</b>	
div 7.3 hdg	(prev pt 7 div C hdg) renum R2 LA
s 97	ss renum R2 LA
<b>Shafts, wells and tunnels</b>	
div 7.4 hdg	(prev pt 7 div D hdg) renum R2 LA
s 98	ss renum R2 LA
<b>Diving</b>	
div 8.1 hdg	(prev pt 8 div A hdg) renum R2 LA
s 99	am regs gazetted 22 June 1956; Act 1957 No 8 sch pt 2; 1999 No 19 sch; ss etc renum R2 LA
<b>Tunnelling</b>	
div 8.2 hdg	(prev pt 8 div B hdg) renum R2 LA
s 100	am regs gazetted 22 June 1956; Act 1957 No 8 sch pt 2; 1986 No 9 s 3; 1999 No 19 sch; ss etc renum R2 LA
<b>Caissons</b>	
div 8.3 hdg	renum R2 LA
s 101	am regs gazetted 22 June 1956; Act 1957 No 8 sch pt 2; 1986 No 9; 1999 No 19 s 2 sch; ss etc renum R2 LA
pt 9 hdg	om 1999 No 19 sch

---

## Endnotes

### 4 Amendment history

---

s 102	om 1999 No 19 sch
s 103	am Act 1957 No 8 sch pt 2 om 1999 No 19 sch
s 104	om 1999 No 19 sch
s 105	om 1999 No 19 sch
s 106	om 1999 No 19 sch
s 107	om 1999 No 19 sch
s 108	om 1999 No 19 sch
s 109	om 1999 No 19 sch
s 110	om 1999 No 19 sch
s 111	om 1999 No 19 sch
s 112	om 1999 No 19 sch
s 113	om 1999 No 19 sch
s 114	om 1999 No 19 sch
s 115	om 1999 No 19 sch
s 116	om 1999 No 19 sch
s 117	om 1999 No 19 sch
s 118	om 1999 No 19 sch
<b>Explosive-powered tools—safety measures</b> pt 9A hdg	sub A2007-3 amdt 3.472

- 
- s 118A ins regs gazetted 9 March 1956
- s 118B ins regs gazetted 9 March 1956; ss etc renum R2 LA
- s 118C ins regs gazetted 9 March 1956; ss renum R2 LA
- s 118D ins regs gazetted 9 March 1956; ss etc renum R2 LA
- s 118E ins regs gazetted 9 March 1956; ss etc renum R2 LA
- s 118F ins regs gazetted 9 March 1956; ss renum R2 LA
- s 118G ins regs gazetted 9 March 1956; ss renum R2 LA
- s 118H ins regs gazetted 9 March 1956
- First-aid equipment**  
div 10.1 hdg (prev pt 10 div A hdg) renum R2 LA
- s 119 am regs gazetted 3 December 1954; ss renum R2 LA
- Shelter, change and dining accommodation**  
div 10.2 hdg (prev pt 10 div B hdg) renum R2 LA
- s 120 ss etc renum R2 LA
- Sanitary conveniences and washing facilities**  
div 10.3 hdg (prev pt 10 div C hdg) renum R2 LA
- s 121 am Act 1957 No 8 sch pt 2 (as am ord 1968 No 5 s 2); 1986  
No 9 s 4; ss etc renum R2 LA
- s 122 am Act 1957 No 8 sch pt 2; ss etc renum R2 LA
- s 123 ss renum R2 LA
- s 124 ss renum R2 LA
- s 125 ss renum R2 LA

## Endnotes

### 4 Amendment history

---

s 126	ss etc renum R2 LA
s 127	am regs gazetted 5 August 1955; Act 2001 No 11 amdt 3.260; ss etc renum R2 LA
s 128	ss renum R2 LA
s 129	ss renum R2 LA
s 130	am regs gazetted 3 December 1954; ss renum R2 LA
s 131	ss renum R2 LA
s 132	am regs gazetted 5 August 1955; ss etc renum R2 LA
s 132A	ins regs gazetted 1 March 1957; ss renum R2 LA
s 133	ss renum R2 LA
s 134	ss renum R2 LA
s 135	ss renum R2 LA
s 136	ss renum R2 LA
s 137	ss renum R2 LA
s 138	am 2000 No 47 s 13; ss renum R2 LA
s 139	ss etc renum R2 LA
s 140	ss renum R2 LA
s 141	ss renum R2 LA
s 142	ss etc renum R2 LA

---

s 143	am Act 1957 No 8 sch pt 2; Act 2001 No 11 amdt 3.261; ss etc renum R2 LA
s 144	am regs gazetted 19 October 1956; Act 2001 No 11 amdt 3.262; ss etc renum R2 LA
s 145	ss etc renum R2 LA
s 150	pars renum R2 LA
s 151	ss renum R2 LA
s 154	pars etc renum R2 LA
s 156	ss etc renum R2 LA
s 157	ss renum R2 LA
s 158	ss etc renum R2 LA
pt 14 hdg	om 2000 No 47 s 14
s 159	am regs gazetted 3 December 1954; Act 1957 No 8 sch pt 2 (as am ord 1976 No 7 s 3; ord 1977 No 28 s 5; ord 1983 No 34 s 5) om 2000 No 47 s 14
s 160	am regs gazetted 3 December 1954; Act 1957 No 8 sch pt 2 om 2000 No 47 s 14
s 161	am regs gazetted 3 December 1954; Act 1957 No 8 sch pt 2 om 2000 No 47 s 14
pt 15 hdg	om 2000 No 47 s 14
s 162	am regs gazetted 3 December 1954; Act 1957 No 8 sch pt 2 (as am ord 1977 No 28 s 5; ord 1983 No 34 s 5) om 2000 No 47 s 14

## Endnotes

### 4 Amendment history

---

- s 163 om Act 1957 No 8 sch pt 2 (as am ord 1983 No 34 s 5)
- s 164 am Act 1957 No 8 sch pt 2 (as am ord 1977 No 28 s 4);  
ss renum R2 LA
- sch 1 am regs gazetted 3 November 1950; regs gazetted 6 March  
1953; regs gazetted 22 June 1956; Act 1957 No 8 sch pt 2  
(as am ord 1976 No 7 s 2; ord 1977 No 28 s 5; ord 1982  
No 15 s 2; ord 1982 No 68 s 2)  
om Act 1957 No 8 sch pt 2 (as am ord 1983 No 34 s 5)
- sch 2 am regs gazetted 22 June 1956; regs gazetted 19 October  
1956  
om Act 1957 No 8 sch pt 2

**Method of treatment of silica paint for the purpose of ascertaining the  
percentage of free silica present**

- sch 3 hdg (prev third sch hdg) renum R2 LA  
sch 3 items renum R2 LA

**Processes to which regulation 73 (1) (o) applies**

- sch 4 hdg (prev fourth sch hdg) renum R2 LA

**Method of treatment of a lead compound for the purpose of determining the  
percentage of dry compound of lead**

- sch 5 hdg (prev fifth sch hdg) renum R2 LA  
sch 5 items renum R2 LA

- sch 6 om 1999 No 19 sch

- sch 7 hdg (prev seventh sch hdg) renum R2 LA

**Medical standards and examination report for compressed air workers**

- sch 8 hdg (prev eighth sch hdg) renum R2 LA  
sch 8 pars renum R2 LA

**Symptoms and treatment of compressed air illness**

- sch 9 hdg (prev ninth sch hdg) renum R2 LA  
sch 9 cl etc renum R2 LA

**Dictionary**

- dict ins A2007-3 amdt 3.473  
def **analogous** reloc from s 3 A2007-3 amdt 3.470  
def **approved** reloc from s 3 A2007-3 amdt 3.470  
def **axial stress** reloc from s 3 A2007-3 amdt 3.470  
def **bearing pressure** reloc from s 3 A2007-3 amdt 3.470



---

def **birdcage scaffolding** ins A2007-3 amdt 3.473  
def **cantilever scaffolding** ins A2007-3 amdt 3.473  
def **conveyor** ins A2007-3 amdt 3.473  
def **dead loads** reloc from s 3 A2007-3 amdt 3.470  
def **designed** reloc from s 3 A2007-3 amdt 3.470  
def **drawings** reloc from s 3 A2007-3 amdt 3.470  
def **dynamically irreversible** reloc from s 3 A2007-3 amdt 3.470  
def **dynamically reversible** reloc from s 3 A2007-3 amdt 3.470  
def **explosive-powered tool** ins A2007-3 amdt 3.473  
def **fixed end** reloc from s 3 A2007-3 amdt 3.470  
def **forged steel** reloc from s 3 A2007-3 amdt 3.470  
def **free end** reloc from s 3 A2007-3 amdt 3.470  
def **heavy duty scaffolding** ins A2007-3 amdt 3.473  
def **high tensile structural steel**reloc from s 3 A2007-3 amdt 3.470  
def **hinged end** reloc from s 3 A2007-3 amdt 3.470  
def **in commission** reloc from s 3 A2007-3 amdt 3.470  
def **independent pole scaffolding** ins A2007-3 amdt 3.473  
def **light duty scaffolding** ins A2007-3 amdt 3.473  
def **light swinging stage** ins A2007-3 amdt 3.473  
def **limiting** reloc from s 3 A2007-3 amdt 3.470  
def **live loads** reloc from s 3 A2007-3 amdt 3.470  
def **mild steel** reloc from s 3 A2007-3 amdt 3.470  
def **projectile** ins A2007-3 amdt 3.473  
def **qualified operator** ins A2007-3 amdt 3.473  
def **roller** reloc from s 3 A2007-3 amdt 3.470  
def **run** ins A2007-3 amdt 3.473  
def **S.A.A. Wiring Rules** reloc from s 3 A2007-3 amdt 3.470  
def **safety gear** ins A2007-3 amdt 3.473  
def **safe working load** (or **working load**) reloc from s 3 A2007-3 amdt 3.470  
def **second-hand** reloc from s 3 A2007-3 amdt 3.470  
def **section** reloc from s 3 A2007-3 amdt 3.470  
def **service lift** ins A2007-3 amdt 3.473  
def **single pole scaffolding** ins A2007-3 amdt 3.473  
def **static counterbalance weights** reloc from s 3 A2007-3 amdt 3.470  
def **strength** reloc from s 3 A2007-3 amdt 3.470  
def **stress** reloc from s 3 A2007-3 amdt 3.470  
def **suspended scaffolding** ins A2007-3 amdt 3.473  
def **toe board** ins A2007-3 amdt 3.473  
def **tool** ins A2007-3 amdt 3.473  
def **transverse stress** reloc from s 3 A2007-3 amdt 3.470  
def **under power** reloc from s 3 A2007-3 amdt 3.470  
def **use** ins A2007-3 amdt 3.473

## Endnotes

5 Earlier republications

---

def **work** ins A2007-3 amdt 3.473  
def **working load** reloc from s 3 A2007-3 amdt 3.470

## 5 Earlier republications

Some earlier republications were not numbered. The number in column 1 refers to the publication order.

Since 12 September 2001 every authorised republication has been published in electronic pdf format on the ACT legislation register. A selection of authorised republications have also been published in printed format. These republications are marked with an asterisk (\*) in column 1. Electronic and printed versions of an authorised republication are identical.

Republication No	Amendments to	Republication date
1	SL 1986 No 9	31 October 1993
2	A2001-44	11 September 2002
3	A2001-44	4 November 2004

© Australian Capital Territory 2007